



**ZAF** significa un sistema modulare completamente personalizzabile e, grazie alla piantana brevettata, sempre aggiornabile e riconfigurabile nel tempo.

Una vasta gamma di accessori e finiture, costantemente ampliata con l'evolvere dei prodotti, e la competenza di un Ufficio Tecnico Commerciale dedicato, rappresentano gli strumenti migliori per rispondere ad ogni esigenza espositiva.

***ZAF** is synonymous with fully personalised modular display systems, featuring patented uprights that ensure layouts can be updated and reconfigured at any time in the future.*

*A huge range of accessories and finishings, extended on an ongoing basis as products evolve, and the expertise of a special Sales and Technical Office provide the best way to satisfy all display requirements.*

Con oltre 50 anni di esperienza, 15.000 metri quadri coperti, 110 addetti, ed un consumo annuale di oltre 9.000 tonnellate di metallo destinato alla trasformazione in componenti d'arredo, **ZAF** è una vera realtà internazionale in continua e progressiva espansione verso nuovi mercati. Un successo reso possibile dalla capacità di rispondere alle esigenze della distribuzione contemporanea, dal piccolo negozio specializzato alla filiera del franchising, ai nuovi modelli urbanistici dove abitazioni, punti vendita e servizi costituiscono un vero sistema integrato.

*With more than 50 years' experience, 15,000 square metres of covered factory space, 110 employees and annual consumption of about 9,000 tonnes of metal for transformation into display units, **ZAF** is a truly international player, constantly expanding into new markets.*

*A success made possible by the company's ability to satisfy modern distribution needs, from small specialist retailers and franchise chains to new urban planning schemes where homes, points of sale and services are integrated to form part of the same system.*

## Metalli Metals

### Tabella metalli Metals table

- C: Metalli cromati  
*Chromium-plated metals*
- V: Metalli verniciati  
*Painted metals*
- P: Materiali plastificati  
*Coated metals*
- N: Materiali neutri  
*Neutral materials*

finitura finish			colori colours
C	P	V	
•			--
			2004
			6018
			6027
		•	7035
			AMA
		•	ANT
			AZZ
			1001
		•	BIA
			BLU
			GIA
			MAR
		•	MTZ
			OXI
		•	PAN
			RO3
			BIMCL
			NRMCL

Disponibilità standard  
Availability standard

### Colori disponibili Colours available

Elenco dei codici colore  
disponibili.

List of color codes  
available .

Il presente simbolo "•", laddove presente, indica la disponibilità in procedura standard. L'assenza indica la disponibilità a richiesta, in procedura extra da concordare.  
*This symbol "•", if present, indicates the availability in standard procedure. The absence indicates a willingness to demand, in extra procedure to be agreed.*

## Legni + profili PVC Wood

### Tabella legni Woods table

- T: Essenze nobilitati  
*Faced Wood*

finitura finish	colori colours	colori colours	colori colours
T			
•	7035	3813	997XS
•	ACE	2293	983XR
•	BIA	990XA	984XA
	FAG	990XM	BLACK
•	MTZ	A838	GREEN
•	PAN	999XA	BEIGE
•	A439	995XM	WHITE
•	ANT	989XR	
	K101	994XS	

Disponibilità standard  
Availability standard

### Essenze disponibili Faced wood available

Elenco dei codici legno  
disponibili.

List of wooden codes  
available .

## Vetri Glasses

finitura finish	colori colours
T	N
•	
	BIAT
•	T

## Specchio Mirror

finitura finish	colori colours
NP	
•	

1	Piantane e accessori <i>Uprights and acces-</i>	15
2	Basi e accessori <i>Bases and accessories</i>	31
3	Fondali e accessori <i>Back Panels and accessories</i>	51
4	Piani e accessori <i>Shelves and accessories</i>	91
5	Mensole <i>Brackets</i>	135
6	Profili <i>Profiles</i>	151
7	Cielini e accessori <i>Shelf heads and accessories</i>	165
8	Accessori ed espositori <i>Accessories and displays</i>	192
9	Vetrine e mobili base <i>Glass and base cabinets</i>	265
10	Stander <i>Display stands</i>	287
11	Montanti e accessori <i>Uprights and accessories</i>	301
12	Tamponamenti e finiture <i>Covering and finishing</i>	337
13	Promozionali, pedane e cesti <i>Promotional displays, baskets and platforms</i>	353
14	Banchi, tavoli e complementi <i>Desks and Tables</i>	365
15	Cabine prova <i>Dressing rooms</i>	391
16	Cartellonistica e merchandising <i>Posters, signs and merchandising</i>	401
>	Finiture e colori <i>Finish and colours</i>	413

### Carichi ammessi per scaffalatura a parete e gondola

#### Permitted loads for wall and gondola shelving

Il carico ammesso si intende uniformemente distribuito su ogni piano e in modo decrescente verso l'alto. The permitted values refer to loads which are uniformly distributed across each shelf and decrease from bottom to top.

In caso di carico bilaterale (gondola) si possono applicare a destra e a sinistra gli stessi carichi ammessi per la parete. In the case of bilateral loading (gondola shelving), the permitted loads for wall shelving may be applied to both right and left sides.

Per aumentare i carichi ammessi delle piantane a parete, si suggerisce di fissarle, purchè i sistemi di fissaggio e la parete siano in grado di sopportare in modo sicuro i carichi supplementari. Fix the uprights to the wall to increase the permitted load, provided that the wall and anchoring system can withstand the extra load within safety limits.

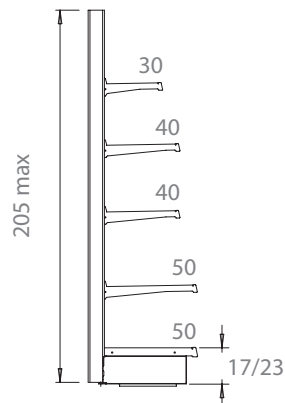

### Portata dei vari tipi di piano

#### Load capacity of the various types of shelves

profondità piano (cm) shelf depth (cm)	25	30	35	40	50	40*	50*	60	70	80
portata piano (kg) shelf load-bearing capacity (kg)	45	140	130	140	130	150	200	210	240	220

\* piano con mensole nervate  
shelf with ribbed brackets

La portata dei piani è calcolata con carico uniformemente distribuito su un piano con lunghezza da 100 cm. The load-bearing capacity of shelves is calculated for a uniformly distributed load across the entire surface.

### Portata dei vari tipi di mensola

#### Load capacity of the various types of brackets

profondità mensola (cm) bracket depth (cm)	25	30	35	40	50	40*	50*	60	70	80
portata mensola (kg) bracket load-bearing capacity (kg)	65	70	65	70	65	80	115	110	130	115

\* mensole nervate  
ribbed brackets

### Portata dei vari tipi di piantana

#### Load capacity of the various types of uprights

profondità media piano (cm) average shelf depth (cm)		30	35	40	50	60	70	80
portata piantana (kg) con base h 17 upright load-bearing capacity (kg) with 17 cm high base	7,2 cm	740	660	600	500	430	--	--
	9 cm	830	740	660	550	470	420	370
	12 cm	990	890	790	650	550	480	420
profondità media piano (cm) average shelf depth (cm)		30	35	40	50	60	70	80
portata piantana (kg) con base h 23 upright load-bearing capacity (kg) with 23 cm high base	9 cm	885	790	705	585	500	450	395
	12 cm	1060	890	790	650	550	480	420

La portata delle piantane corrisponde alla somma ammessa del carico di tutti i piani escluso quello di base. Per profondità diverse, fare la somma di queste e dividere per il numero dei piani; ottenuta così la profondità media, riferirsi alla misura più vicina. Permitted sum of loads on all shelves, excluding the base shelf. For shelves of differing depths, add all the depths and divide by the number of levels. After calculating the average depth, locate the value closest to it.

### Carichi ammessi per scaffalatura a parete e gondola ExtraSlim

Permitted loads for wall and gondola ExtraSlim shelving

Il carico ammesso si intende uniformemente distribuito su ogni piano e in modo decrescente verso l'alto.

The permitted values refer to loads which are uniformly distributed across each shelf and decrease from bottom to top.

In caso di carico bilaterale (gondola) si possono applicare a destra e a sinistra gli stessi carichi ammessi per la parete.

In the case of bilateral loading (gondola shelving), the permitted loads for wall shelving may be applied to both right and left sides.

Per aumentare i carichi ammessi delle piantane a parete, si suggerisce di fissarle, purchè i sistemi di fissaggio e la parete siano in grado di sopportare in modo sicuro i carichi supplementari.

Fix the uprights to the wall to increase the permitted load, provided that the wall and anchoring system can withstand the extra load within safety limits.

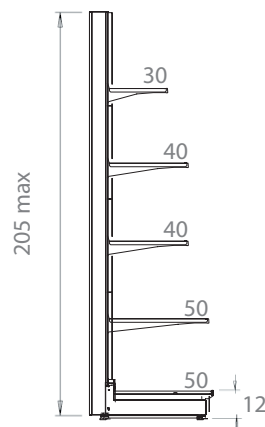

### Portata dei vari tipi di piano EXTRASLIM

Load capacity of the various types of shelves

profondità piano (cm) shelf depth (cm)	25	30	35	40	50	40*	50*	60	70	80
portata piano (kg) shelf load-bearing capacity (kg)	35	130	120	130	130	140	180	190	220	200

\* piano con mensole nervate  
shelf with ribbed brackets

La portata dei piani è calcolata con carico uniformemente distribuito su un piano con lunghezza da 100 cm.

The load-bearing capacity of shelves is calculated for a uniformly distributed load across the entire surface.

### Portata dei vari tipi di mensola EXTRASLIM

Load capacity of the various types of brackets

profondità mensola (cm) bracket depth (cm)	25	30	35	40	50	40*	50*	60	70	80
portata mensola (kg) bracket load-bearing capacity (kg)	65	70	65	70	65	80	115	110	130	115

\* mensole nervate  
ribbed brackets

### Portata dei vari tipi di piantana CON BASE EXTRASLIM

Load capacity of the various types of uprights

profondità media piano (cm) average shelf depth (cm)		30	35	40	50	60	70	80
portata piantana (kg) con base h 17 upright load-bearing capacity (kg) with 17 cm high base	7,2 cm	740	660	600	500	430	--	--
	9 cm	830	740	660	550	470	420	370
	12 cm	990	890	790	650	550	480	420
profondità media piano (cm) average shelf depth (cm)		30	35	40	50	60	70	80
portata piantana (kg) con base h 23 upright load-bearing capacity (kg) with 23 cm high base	9 cm	885	790	705	585	500	450	395
	12 cm	1060	890	790	650	550	480	420

La portata delle piantane corrisponde alla somma ammessa del carico di tutti i piani escluso quello di base. Per profondità diverse, fare la somma di queste e dividere per il numero dei piani; ottenuta così la profondità media, riferirsi alla misura più vicina.

Permitted sum of loads on all shelves, excluding the base shelf.

For shelves of differing depths, add all the depths and divide by the number of levels. After calculating the average depth, locate the value closest to it.

Elementi a parete con piani a liste, piani interi e accessori  
Wall units with plank shelves, one piece shelves and accessories

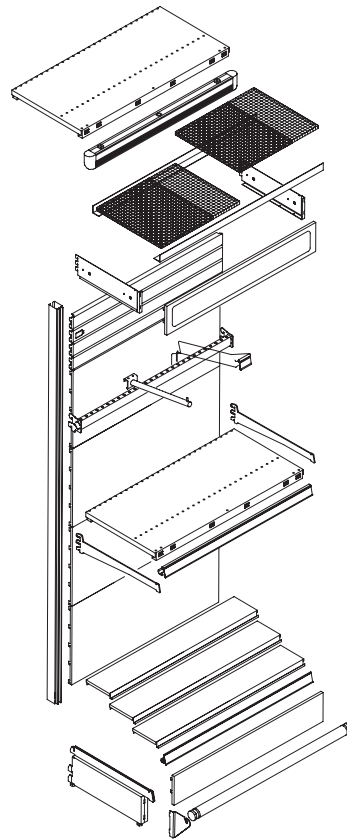
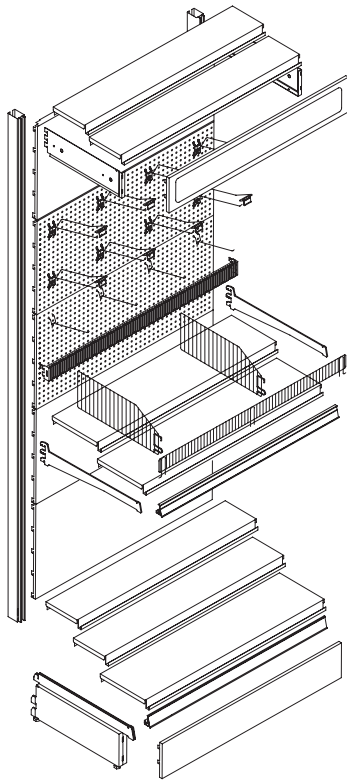

Elemento a gondola con mobili base e accessori  
Gondola unit with base cabinets and accessories

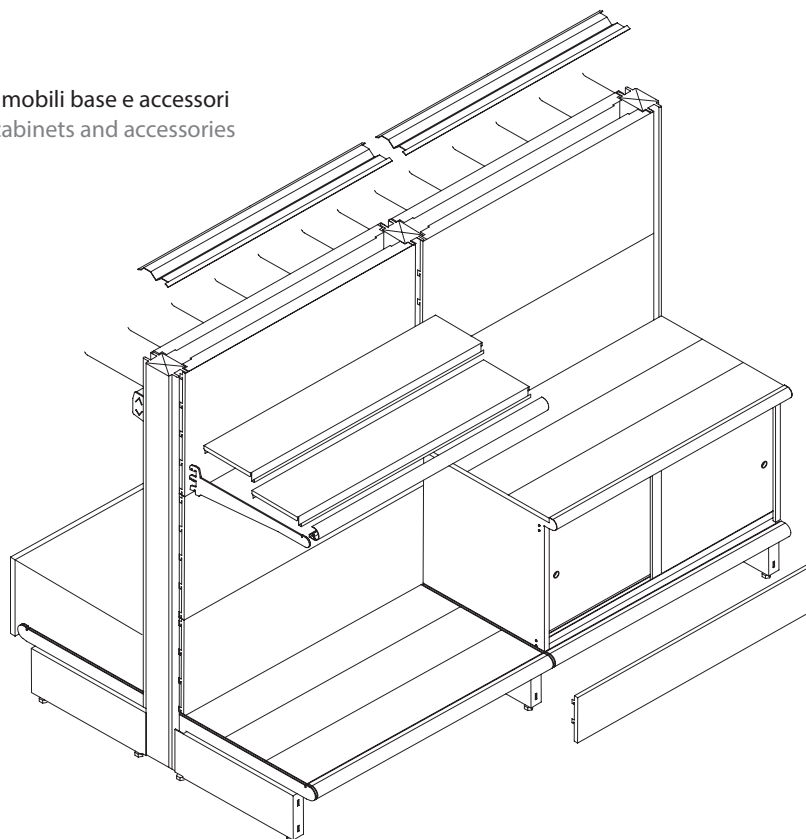

Elementi a parete con piani ExtraSlim  
Wall units with one piece ExtraSlim shelves.

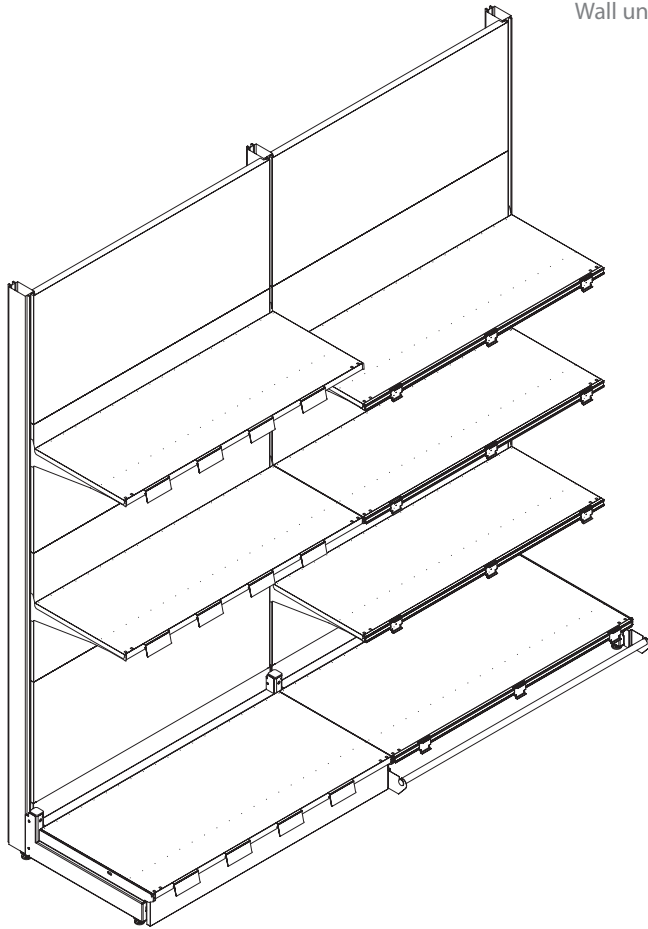

Elemento a gondola con piani ExtraSlim e Mini-ExtraSlim  
ExtraSlim and Mini-ExtraSlim gondola unit

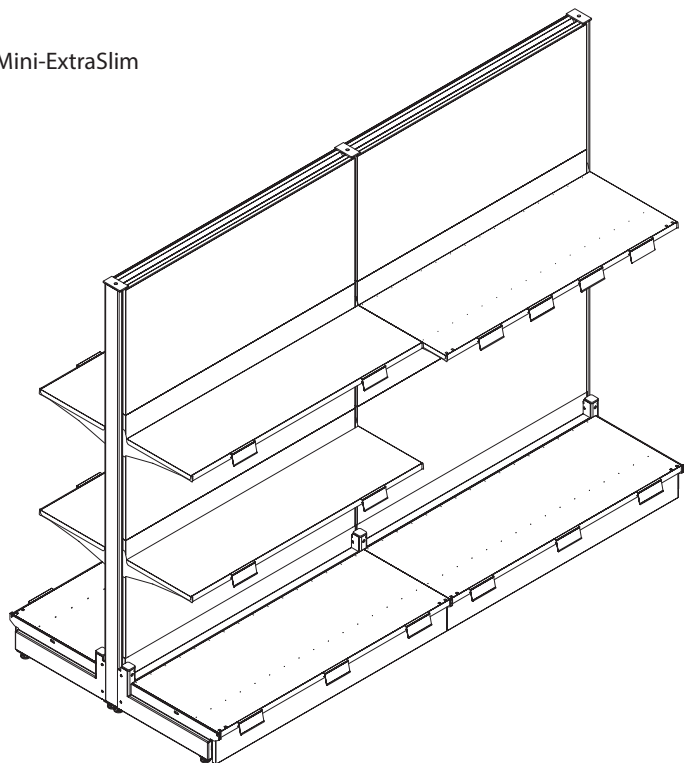

Elementi a parete Minirack completi di piani anteriori supplementari

*Wall set-back Minirack units with front shelves*

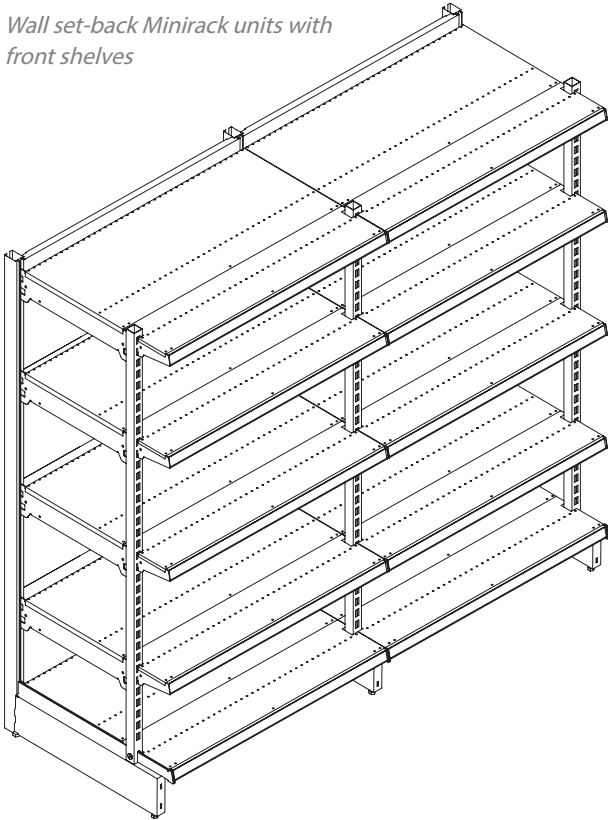

Elementi a parete Minirack completi di piani anteriori supplementari ExtraSlim.

*Wall set-back Minirack units with front ExtraSlim shelves*

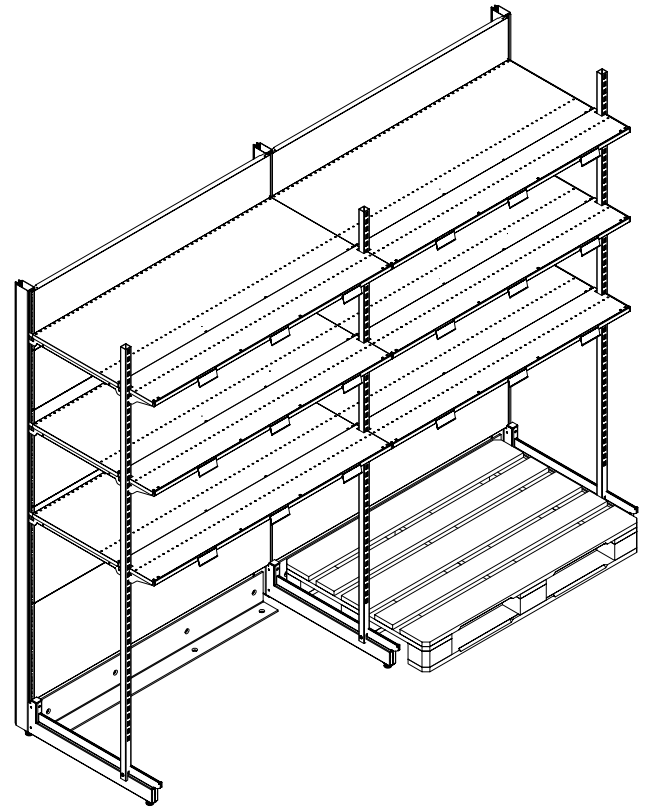

Elementi a parete Minirack con supporti per piantana anteriore

*Wall Minirack units with supports for front uprights*

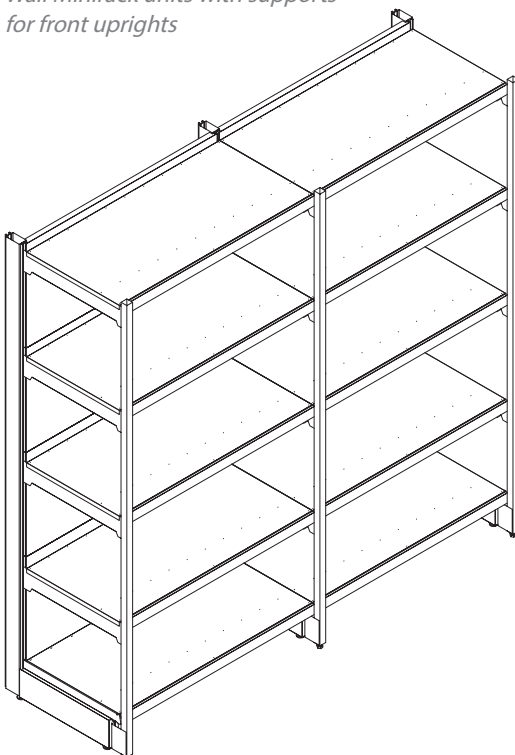

Elementi a parete Minirack con supporti per piantana anteriore ExtraSlim

*Wall Minirack units with supports for front uprights ExtraSlim*

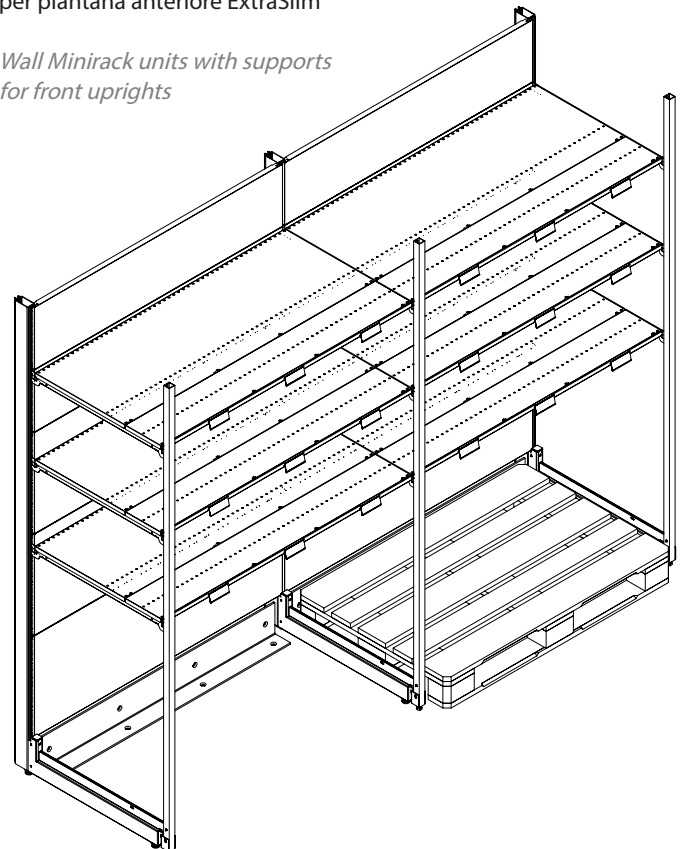



Elementi a parete con piani a liste, piani interi e piani in filo

*Wall units with plank shelves, one piece shelves and wire shelves*

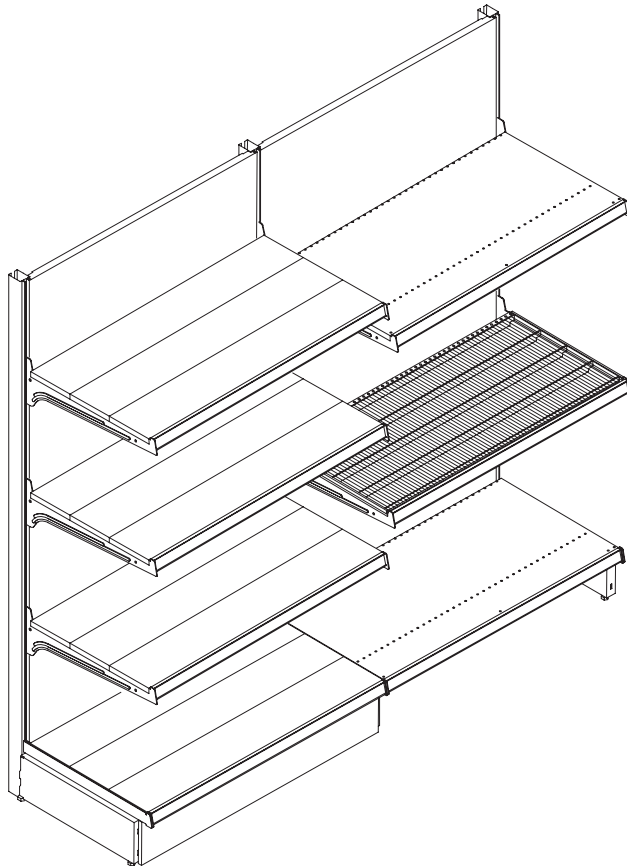

Elementi a parete con piani in legno, piano in vetro a sbalzo e piano in vetro stander

*Wall units with wooden shelves, overhanging glass shelf and display stand glass shelf*

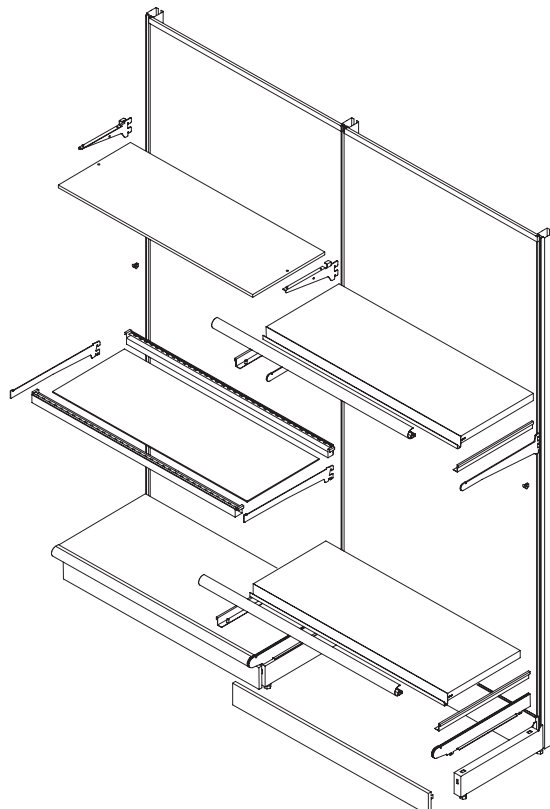

Elementi a parete con espositore e accessori  
per libri e riviste

*Wall units with display and accessories  
for books and magazines*

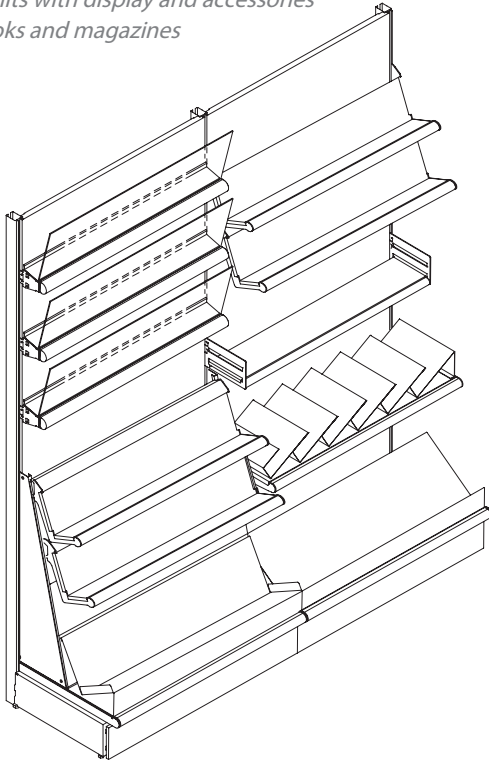

Elementi a parete con espositore e accessori  
per libri e riviste ExtraSlim

*Wall ExtraSlim units with display and  
accessories for books  
and magazines*

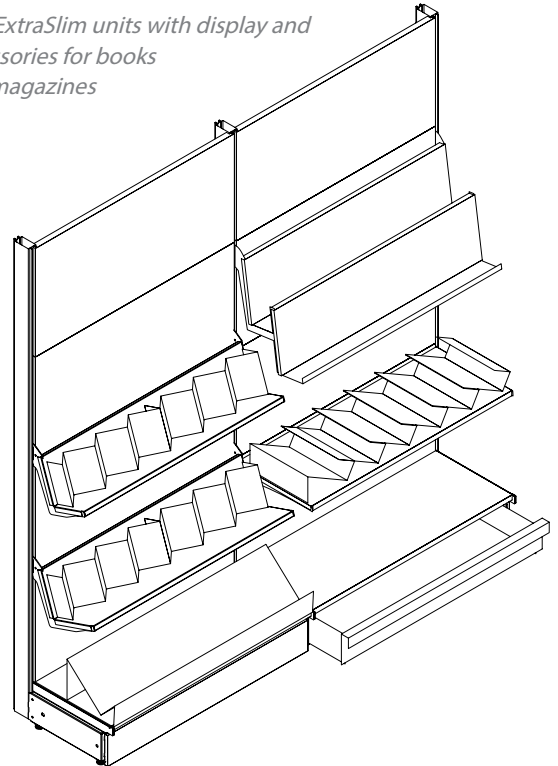

Elementi a parete con espositori per  
CD e DVD con base 17 h  
Wall units with displays for CDs  
and DVDs with h 17 bases

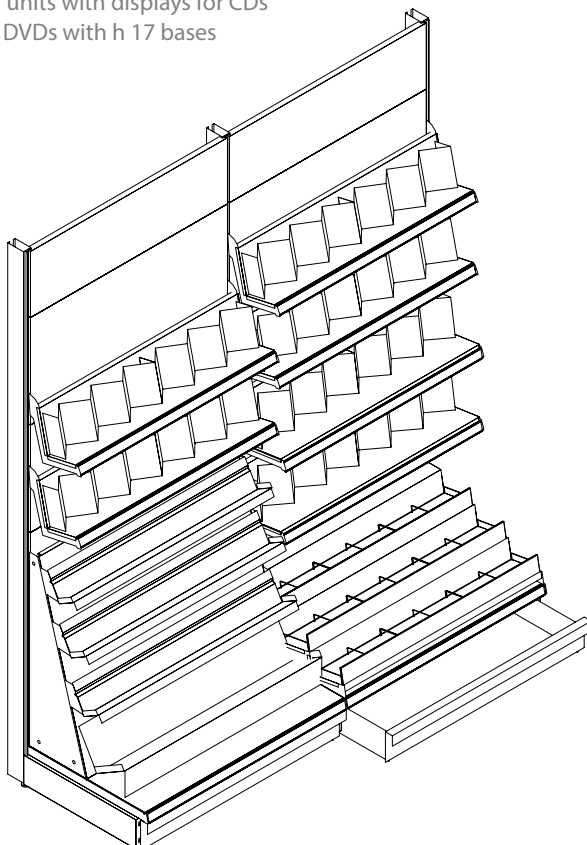

Elementi a parete con espositori per  
CD e DVD ExtraSlim con base Slim h 17  
Wall ExtraSlim units with displays  
for CDs and DVDs with Slim bases

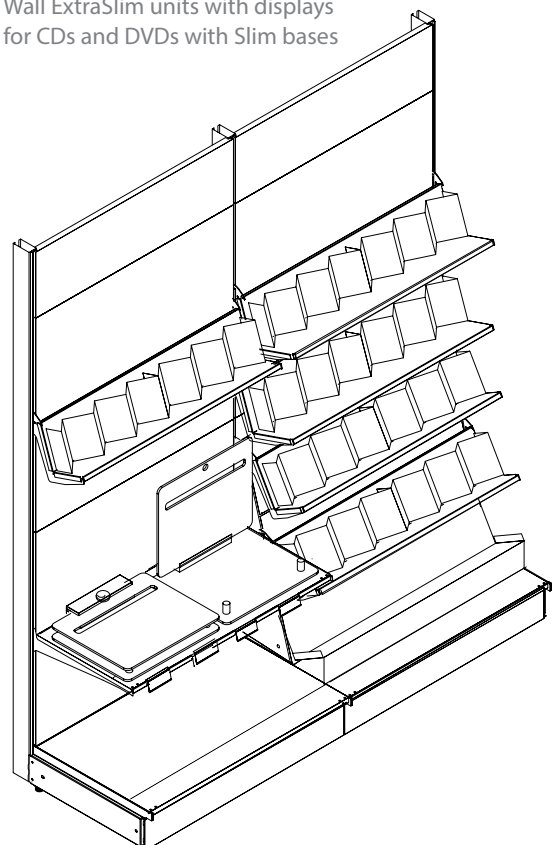

Elementi a parete con gradinate, piani a L per libri e riviste  
Wall units with step displays, L shaped shelves for books and magazines

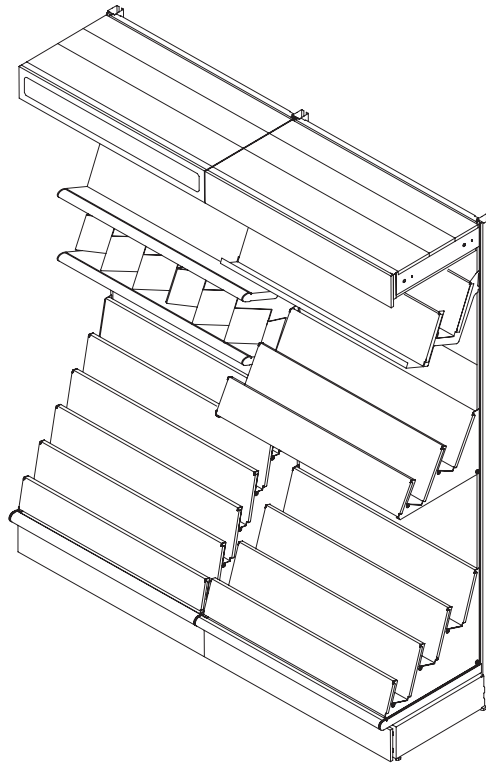

Elementi a gondola con accessori per CD, DVD e Home Video  
Gondola units with accessories for CDs and DVDs and Home Video

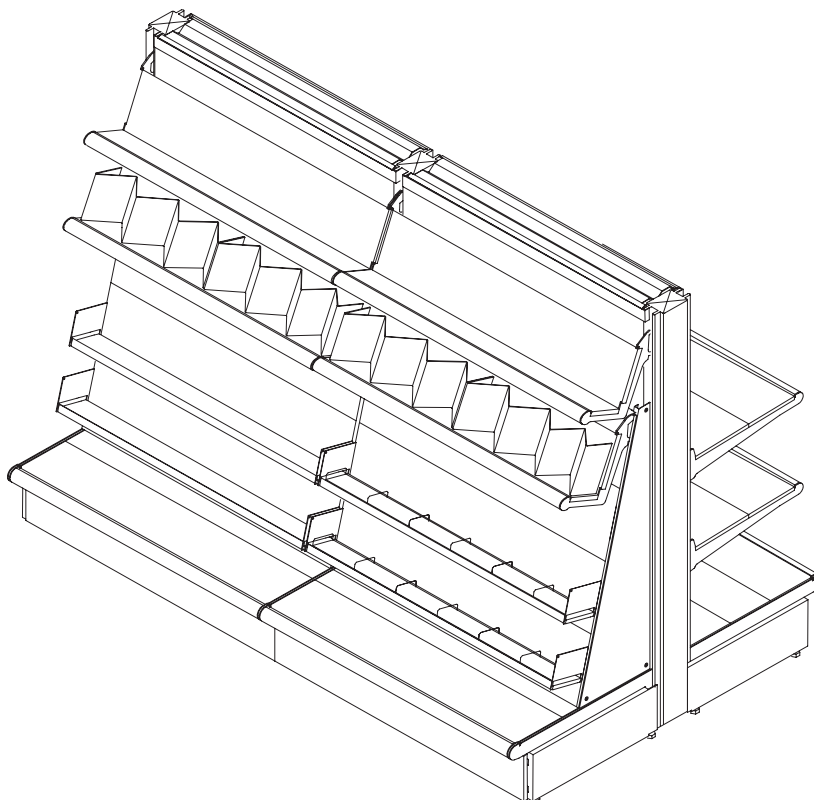

Elementi a parete con piani a liste e piani interi e relativi accessori (frontali e divisori) in vetro e in filo

Wall units with plank shelves and one piece shelves and glass or wire accessories (risers and dividers)

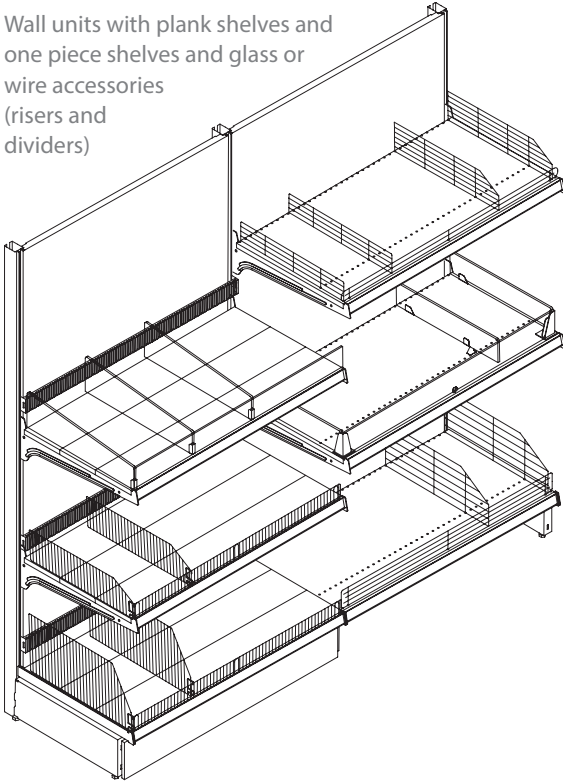

Elementi a parete con piani interi ExtraSlim e relativi accessori (frontali e divisori) in vetro e in filo

Wall units with plank shelves and one piece shelves and glass or wire accessories (risers and dividers)

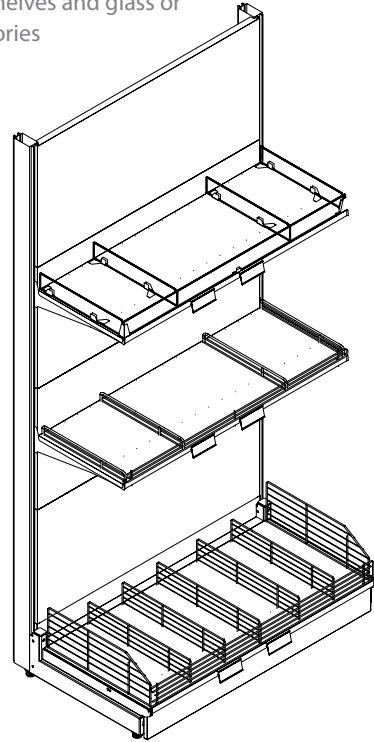

Elementi a parete con mensole e traversi per piani ortofrutta

Wall units with brackets and crosspieces for fruit&vegetables shelving

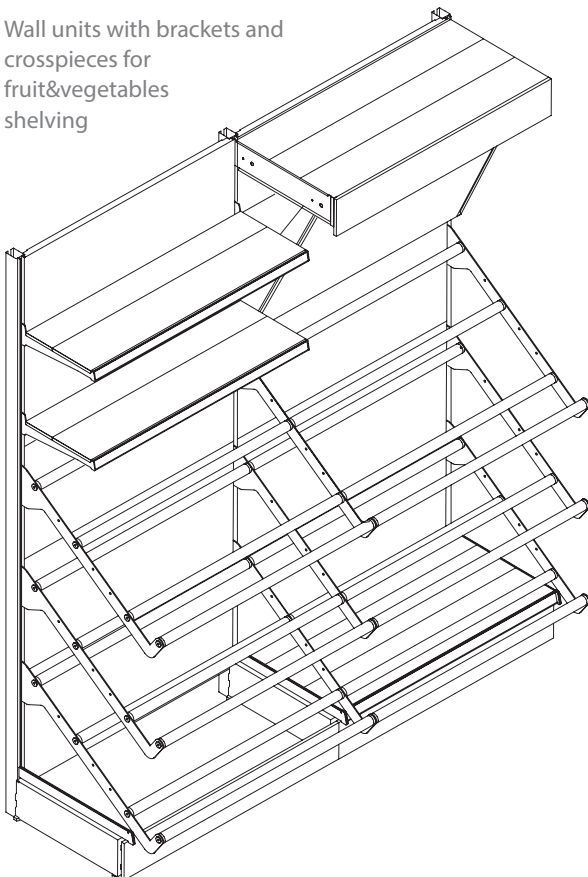

Elementi a parete con mensole e traversi per piani ortofrutta

Wall units with brackets and crosspieces for fruit&vegetables shelving

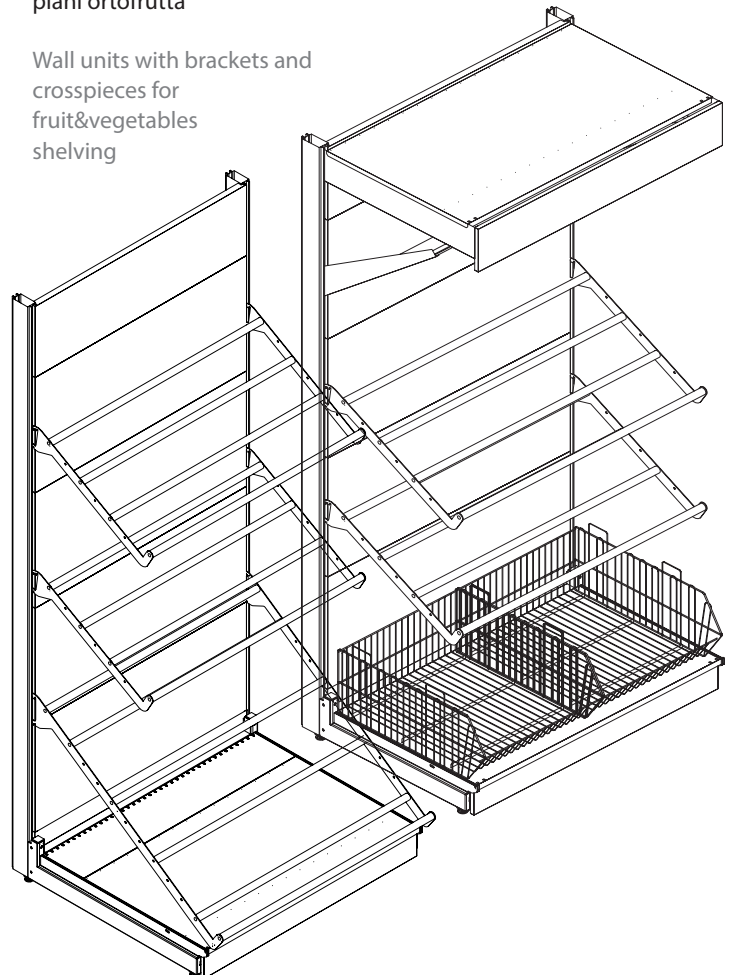

Elementi a parete con mobili base, vetrine pensili e accessori  
Wall units with base cabinets, hanging glass cabinet and accessories

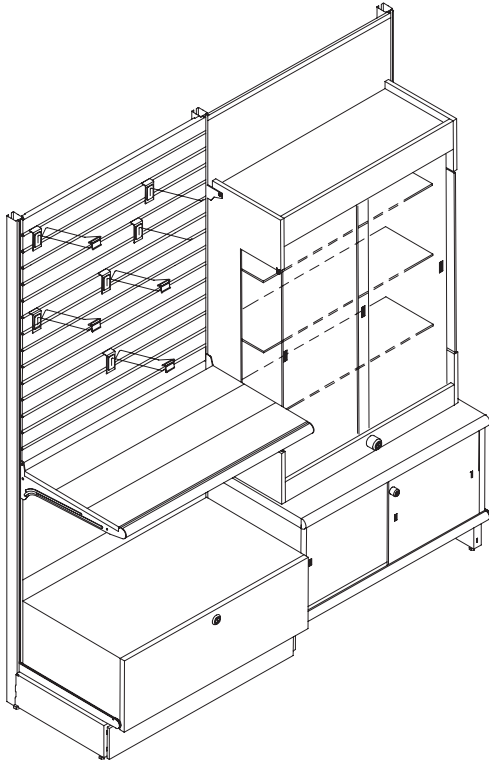

Elementi a gondola con piani a liste e piani in filo inclinabili  
Gondola units with plank shelves and wire several position shelves

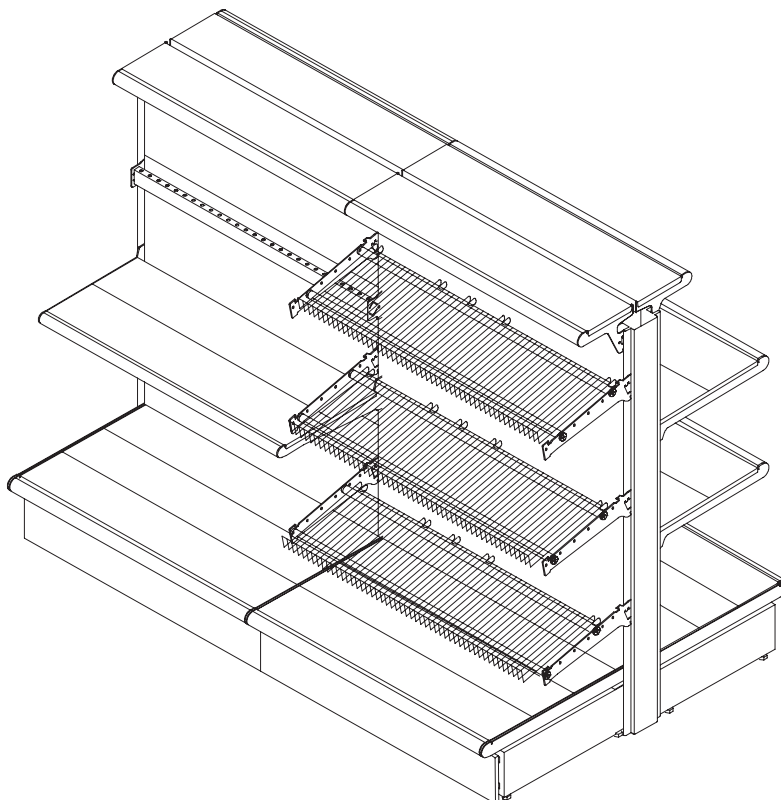

**note**  
*notes*

# Piantane *Uprights*

# 1

Piantane tubolari, piantane a parete, piantane stander, piantane Minirack, piantane angolari e accessori: prolunghe, coperchi, ruote, elementi per il fissaggio.

*Tubular uprights, wall uprights, display stand uprights, Minirack uprights, angle uprights and accessories: extensions, caps, wheels, fixing pieces.*

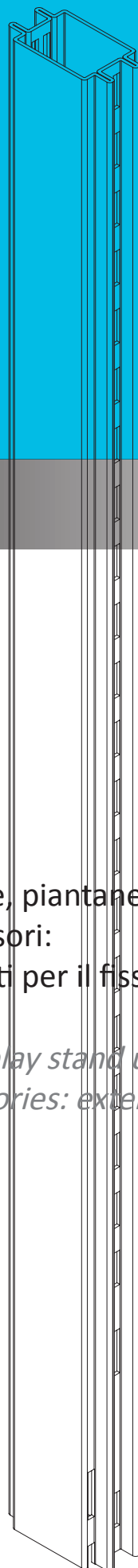





Passo delle strutture a parete e centrali

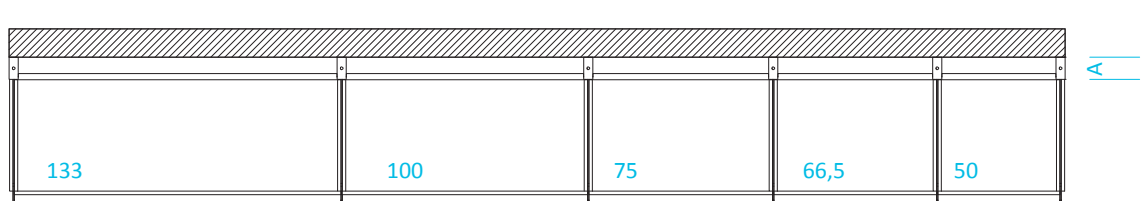

Bay for wall or gondola units

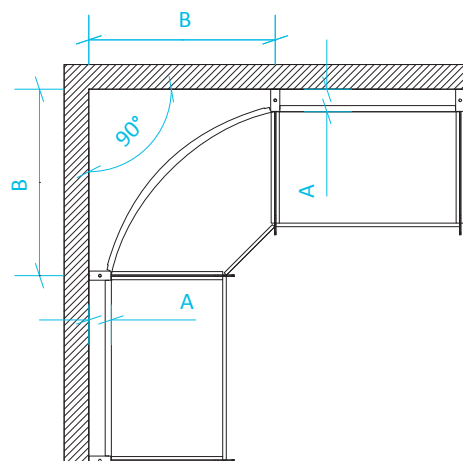

Misure ingombro **angolo chiuso con piani in legno**

Closed wood corner measurements





	A	B
	5	71,6
	7,2	73,8
	9	75,6

Misure ingombro **angolo aperto con piani in legno**

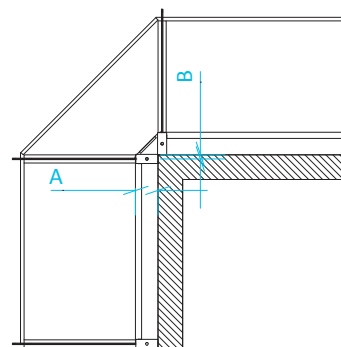
Open wood corner measurements





	A	B
	5	5,5
	7,2	3,1
	9	1,6

Misure ingombro **angolo chiuso con piani metallo**

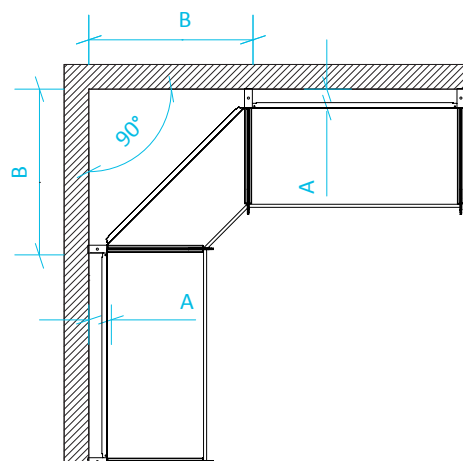
Closed metal corner measurements





	A	B
	5	71,6
	7,2	73,8
	9	75,6

Misure ingombro **angolo aperto con piani in metallo**

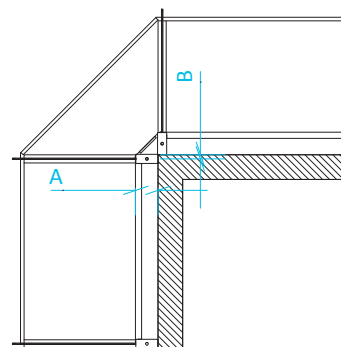



Open metal corner measurements



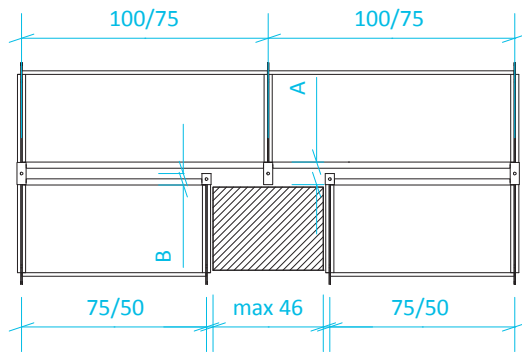



	A	B
	5	5,5
	7,2	3,1
	9	1,6

Dimensioni ed utilizzo piantane zone pilastri  
*Upright dimensions for pillar areas*

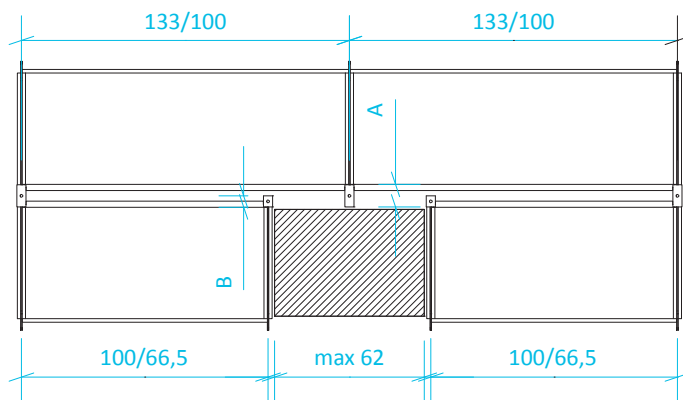

	A	B
	7,2	5 
	9	5 



	A	B
	9	5 
	12	9 

### Accessori fissaggio piantane a parete con espansore o con base h 10 - vedi 1.8

Fixing accessories for wall uprights with expander or 10 cm high base - see 1.8

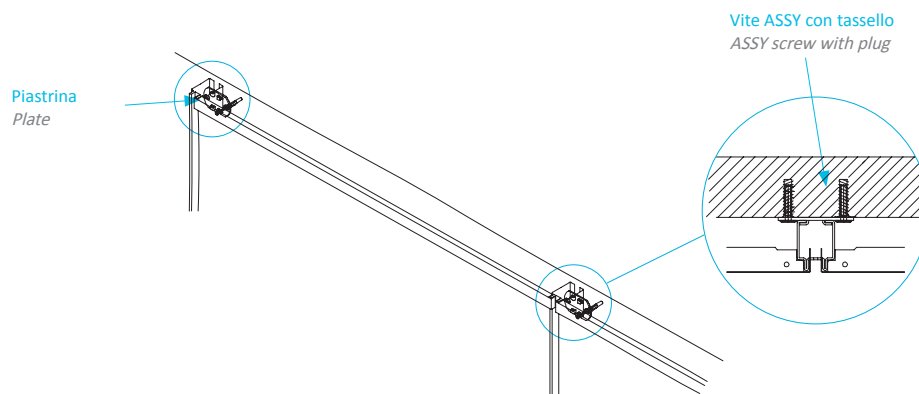
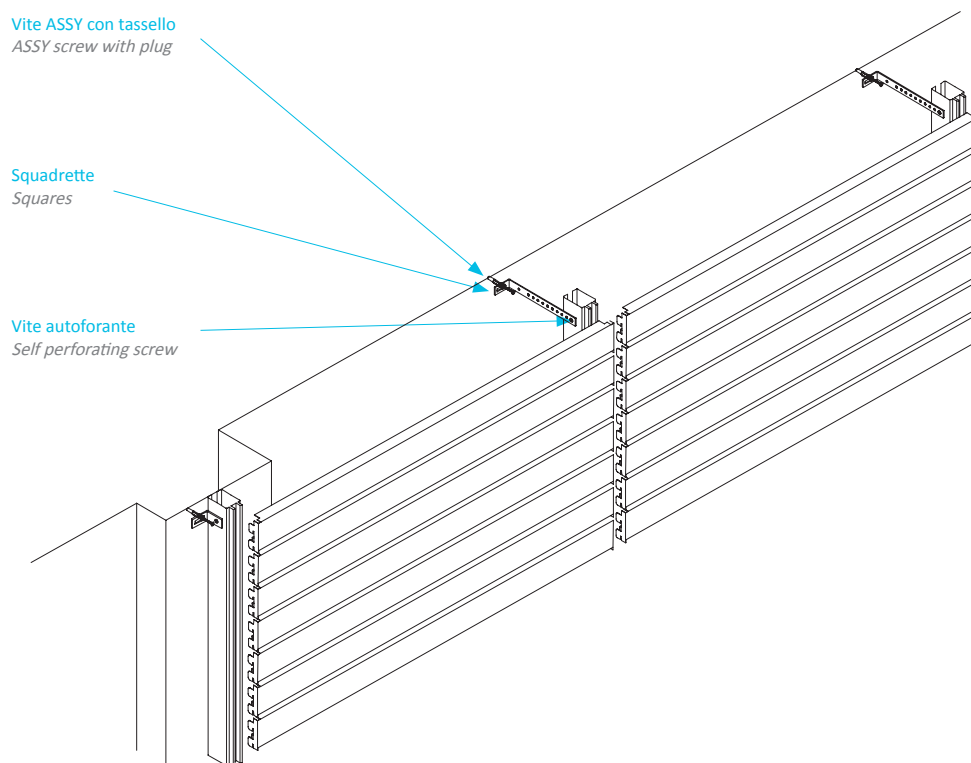

Fissaggio diretto a parete  
con piastrina vite e  
tassello  
Direct fixing

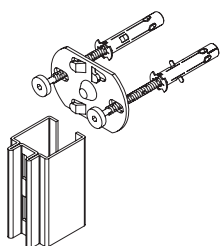

Fissaggio diretto  
con piastrina  
Direct fixing with plate

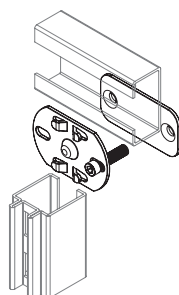

Passo delle strutture a parete e centrali con montanti 3x3  
Bay for 3x3 uprights wall or gondola units

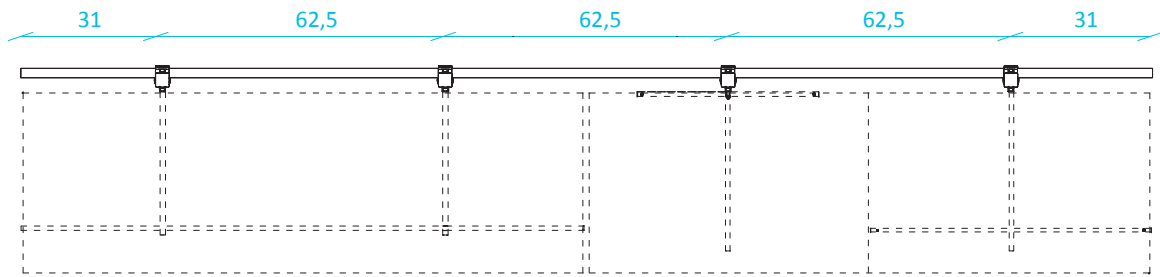

Passo 62,5  
62,5 Bay

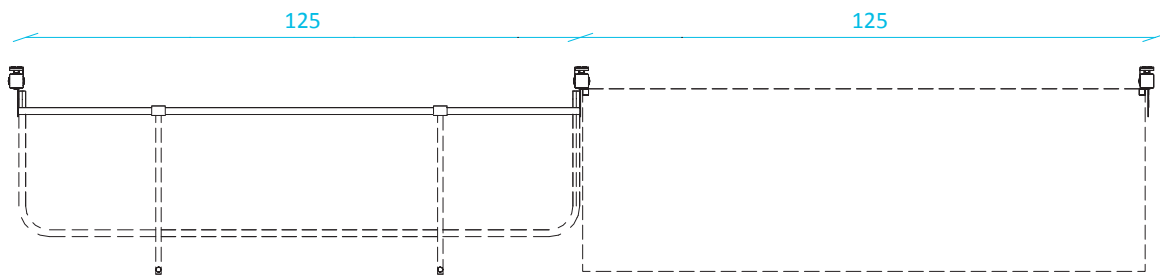

Passo 125  
125 Bay

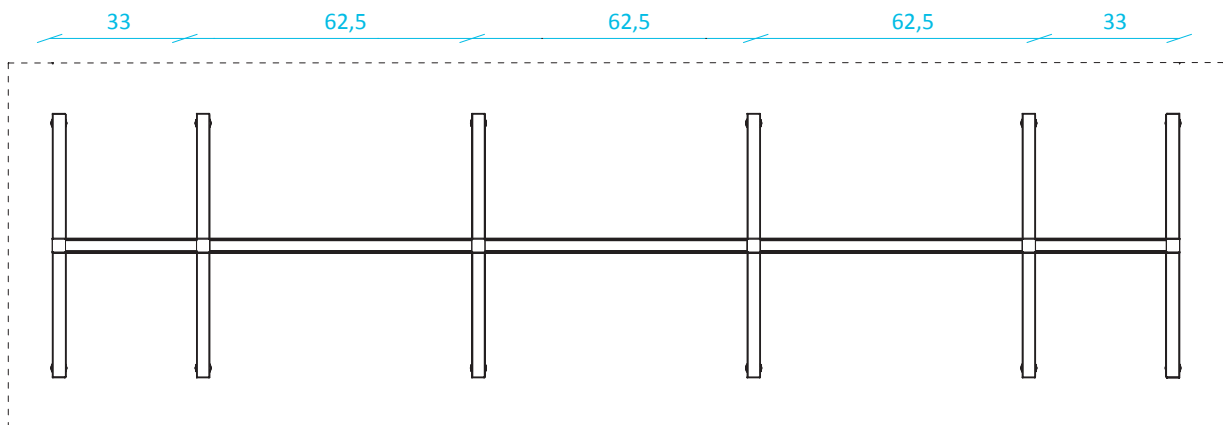

Passo 62,5  
62,5 Bay

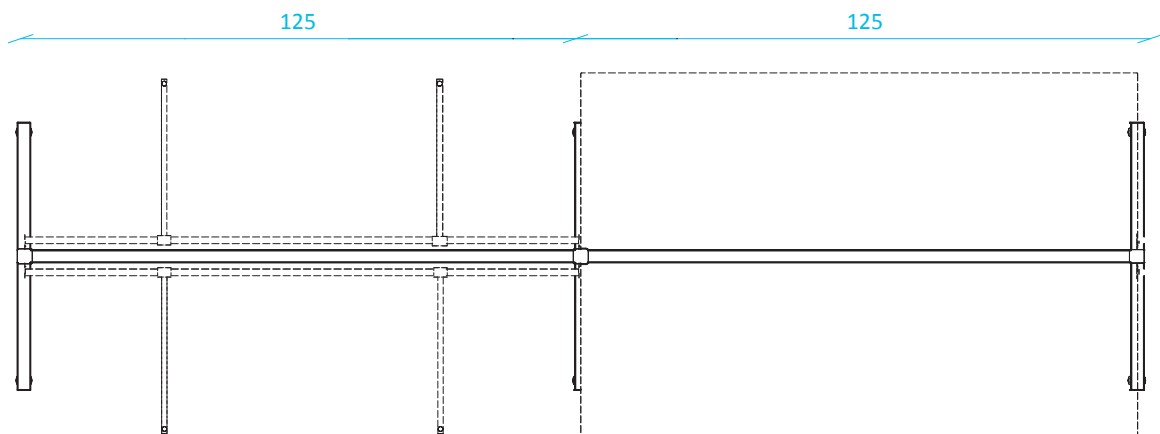

Passo 125  
125 Bay

Accessori fissaggio piantane a parete per montanti 3x3  
*Fixing accessories for wall 3x3 uprights*

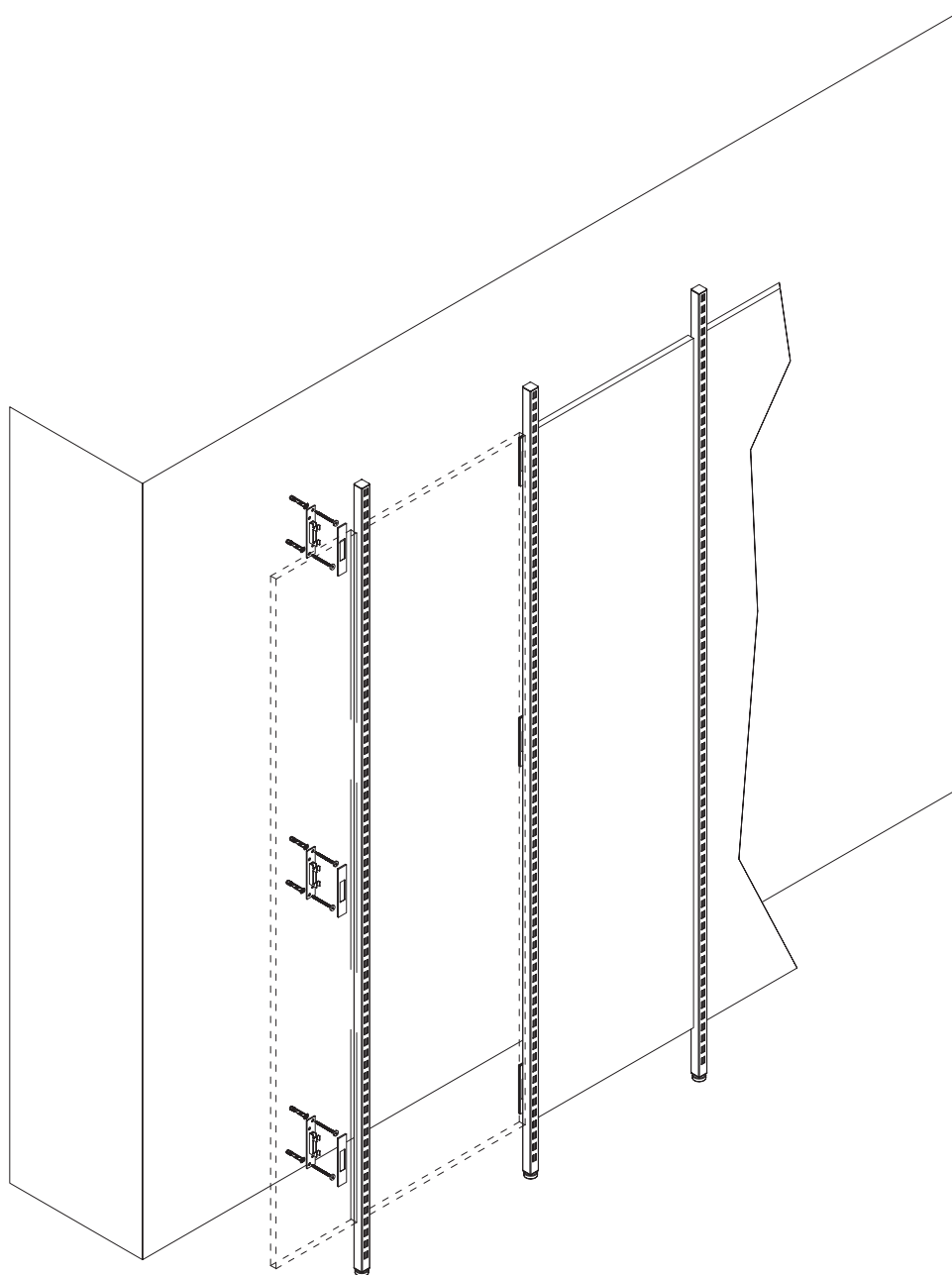

Fissaggio diretto a parete con supporto per fissaggio, carter di chiusura, viti e tassello  
*Direct fixing with support and cover for wall*

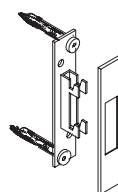
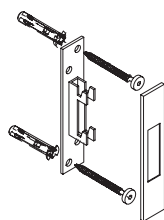



Piantane  
Uprights

1.1

Piantane tubolari  
Tubular uprights

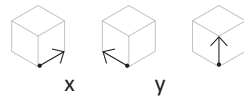
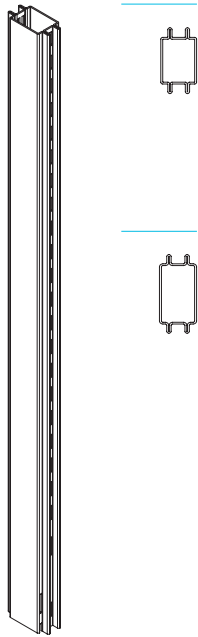

x	y	z	codice code	note notes
4	7,2	93	10.245	
4	7,2	122	10.246	
4	7,2	140	10.247	
4	7,2	158	10.248	
4	9	140	10.335	
4	9	158	10.249	
4	9	187	10.250	
4	9	205	10.251	
4	9	223	10.318	
4	9	234	10.252	
4	9	252	10.253	
4	9	299	10.254	
4	9	327	10.255	

finitura finish	colori colours
V	2004
	6018
	6027
•	7035
	AMA
•	ANT
	AZZ
	1001
•	BIA
	BLU
	GIA
	MAR
•	MTZ
•	PAN
	RO3
	BIMCL
	NRMCL
•	OXI



Piantane  
Uprights

1.2

Prolunghe per piantane tubolari  
Tubular extensions

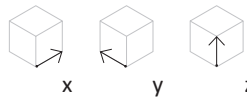
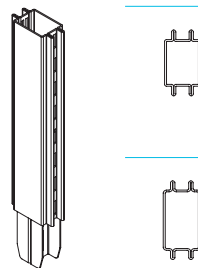

x	y	z	codice code	note notes
4	7,2	18	10.345	
4	7,2	29	10.260	
4	7,2	47	10.261	
4	9	18	10.321	
4	9	29	10.262	
4	9	47	10.263	

finitura finish	colori colours	colori colours
V	2004	MAR
	6018	• MTZ
	6027	• PAN
•	7035	RO3
	AMA	BIMCL
•	ANT	NRMCL
	AZZ	• OXI
	1001	
•	BIA	
	BLU	
	GIA	

Piantane  
Uprights

1.3

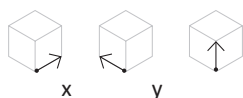
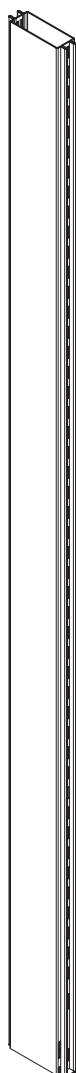
Piantane tubolari  
Tubular uprights

x

y

z

codice  
codenote  
notesfinitura  
finishcolori  
colours

x	y	z	codice code	note notes
4	12	187	10.257	
4	12	205	10.258	
4	12	223	10.320	
4	12	234	10.259	
4	12	252	10.302	
4	12	299	10.290	

finitura finish	colori colours
V	2004
	6018
	6027
•	7035
	AMA
•	ANT
	AZZ
	1001
•	BIA
	BLU
	GIA
	MAR
•	MTZ
•	PAN
	RO3
	BIMCL
	NRMCL
•	OXI

**Le piantane con profondità  
12, hanno uno speciale  
rinforzo alla base.**

*12 cm deep uprights have a special  
lower stiffener.*

Piantane  
Uprights

1.4

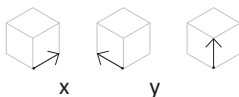
Prolunghe per piantane tubolari  
Tubular extensions

x

y

z

codice  
codenote  
notesfinitura  
finishcolori  
colourscolori  
colours

x	y	z	codice code	note notes
4	12	18	10.322	
4	12	29	10.264	
4	12	47	10.265	

finitura finish	colori colours	colori colours
V	2004	MAR
	6018	• MTZ
	6027	• PAN
•	7035	RO3
	AMA	BIMCL
•	ANT	NRMCL
	AZZ	• OXI
	1001	
•	BIA	
	BLU	
	GIA	





Piantane  
Uprights

1.5

Piantane a parete  
Wall uprights

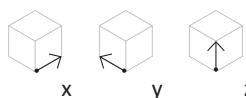

x	y	z	codice code	note notes
4	5	158	10.203	
4	5	187	10.204	
4	5	205	10.205	
4	5	223	10.319	
4	5	234	10.206	
4	5	252	10.207	
4	5	299	10.212	
4	5	327	10.217	
4	9	205	10.218	
4	9	234	10.219	
4	9	252	10.220	
4	9	299	10.222	
4	9	327	10.235	

finitura finish	colori colours
V	2004
	6018
	6027
•	7035
	AMA
•	ANT
	AZZ
	1001
•	BIA
	BLU
	GIA
	MAR
•	MTZ
•	PAN
	RO3
	BIMCL
	NRMCL
•	OXI



Piantane  
Uprights

1.6

Prolunghe per piantane a parete  
Wall extensions

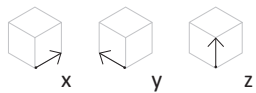
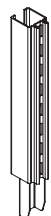

x	y	z	codice code	note notes
4	5	18	10.-45	
4	5	29	10.-14	
4	5	47	10.-15	
4	9	18	10.344	
4	9	29	10.-16	
4	9	47	10.-17	

finitura finish	colori colours
V	2004
	6018
	6027
•	7035
	AMA
•	ANT
	AZZ
	1001
•	BIA
	BLU
	GIA
	MAR
•	MTZ
•	PAN
	RO3
	BIMCL
	NRMCL
•	OXI



Accessori per Piantane  
Upright Accessories

1.7

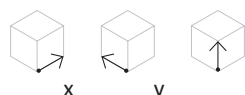
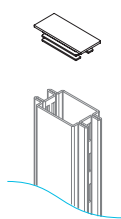
Coperchio in PVC per piantane tubolari  
PVC cap for tubular uprights

x	y	z	codice code	note notes
3,7	7,2	--	12.-27	
3,7	9	--	12.-28	

finitura finish	colori colours
T	
•	7035
•	ANT
•	BIA
•	MTZ
•	PAN

Accessori per Piantane  
Upright Accessories

1.8

Ferramenta per fissaggio piantane a parete  
Fixing accessories for wall uprights

Vite autoforante  $\phi=5,5$   $y=22$  mm  
Self perforating screw  $\phi=5,5$   $y=22$  mm

codice  
code

34.521

finitura e  
colore  
finish &  
colour

C



Squadretta  $x=4$   $y=4$  cm  
Square  $x=4$   $y=4$  cm

12.-01

C

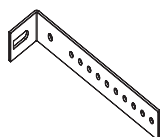

Squadretta  $x=4,5$   $y=21$  cm  
Square  $x=4,5$   $y=21$  cm

36.228

C

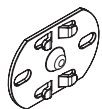

Piastrina  $y=7,5$   $z=5$  cm  
(specifica per piantane da 5)  
Plate  $y=7,5$   $z=5$  cm  
(only for wall uprights with  $y=5$  cm)

36.124

C

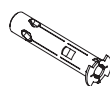

Tassello PVC  $\phi=10$   $y=62$  mm  
PVC plug  $\phi=10$   $y=62$  mm

12.-37



Vite  $\phi=7$   $y=75$  mm tipo: ASSY per tassello  
ASSY screw  $\phi=7$   $y=75$  mm for plug

12.-41

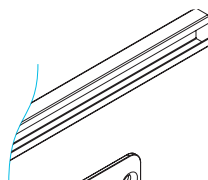

Barra a C  $x=310$  cm  
C shaped metal bar  $x=310$  cm

34.221

N

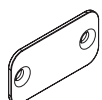

Piastrina  $y=8$   $z=4$  cm (per fissaggio alla C)  
Plate  $y=7,5$   $z=5$  cm (for C shaped bar and upright fastening)

12.-12

C



Vite brugola  $\phi=8$   $y=25$  mm per piastrina  
Allen screw for plate upright fixing

34.524



Vite per tassello  $\phi=4,5$   $y=50$  mm  
Allen screw for plate upright fixing

FE.244



Tassello in PVC per cartongesso  
Allen screw for plate upright fixing

FE.240





Piantane  
Uprights

1.9

Piantane Minirack  
Minirack uprights

	x	yz		codice code	note notes	finitura finish	colori colours	colori colours
base h 12 h12 base	3	3	187	10.447		V		
	3	3	205	10.410			2004	MAR
	3	3	223	10.397			6018	• MTZ
	3	3	234	10.409			6027	• PAN
base h 17/23 h17/23 base	3	3	234	10.409			• 7035	RO3
	3	3	187	10.208			AMA	BIMCL
	3	3	205	10.209			• ANT	NRMCL
	3	3	223	10.324			AZZ	• OXI
	3	3	234	10.210			1001	
							• BIA	
							BLU	
							GIA	

lato interno con cavettatura  
upright slots on inner side

Le piantane Minirack sono dotate di vite, dado e regolatore  
Minirack uprights are sold with screw, nut and adjuster

**BASE 12 H Minirack**  
H 12 BASE Minirack

**BASE 17 H Minirack**  
H 17 BASE Minirack

Accessori per Piantane  
Upright Accessories

1.10

Supporto dx/sx per base h 17/23 per piantana Minirack  
Rh/lh support for Minirack upright for 17/23 cm high bases

	x	y	z	codice code	finitura e colore finish & colour	note notes
	--	9,5	11	34.233	C	

Accessori per Piantane  
Upright Accessories

1.11

Supporto dx/sx per base h 12 Extrabassa per piantana Minirack  
Rh/lh support for Minirack upright for 12 cm high bases

	x	y	z	codice code	finitura e colore finish & colour	note notes
dx/rh	--	9,5	6	34.551	C	
sx/lh	--	9,5	6	34.605	C	





Piantane  
Uprights

1.12

Piantane Mirirack arretrate  
Set-back Mirirack upright



	 x	 y	 z	codice code	note notes
base h 12 <i>h12 base</i>	3	3	205	10.410	
	3	3	223	10.411	
	3	3	234	10.412	
base h 17 <i>h17 base</i>	3	3	205	10.288	
	3	3	223	10.325	
	3	3	234	10.289	

**Le piantane Mirirack  
sono dotate di vite  
e dado Mirirack**

*uprights are sold with  
screw nut*

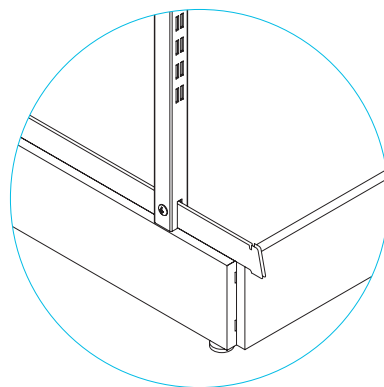

finitura finish	colori colours
V	2004
	6018
	6027
	• 7035
	AMA
	• ANT
	AZZ
	1001
	• BIA
	BLU
	GIA
	MAR
	• MTZ
	• PAN
	RO3
	BIMCL
	NRMCL
	• OXI

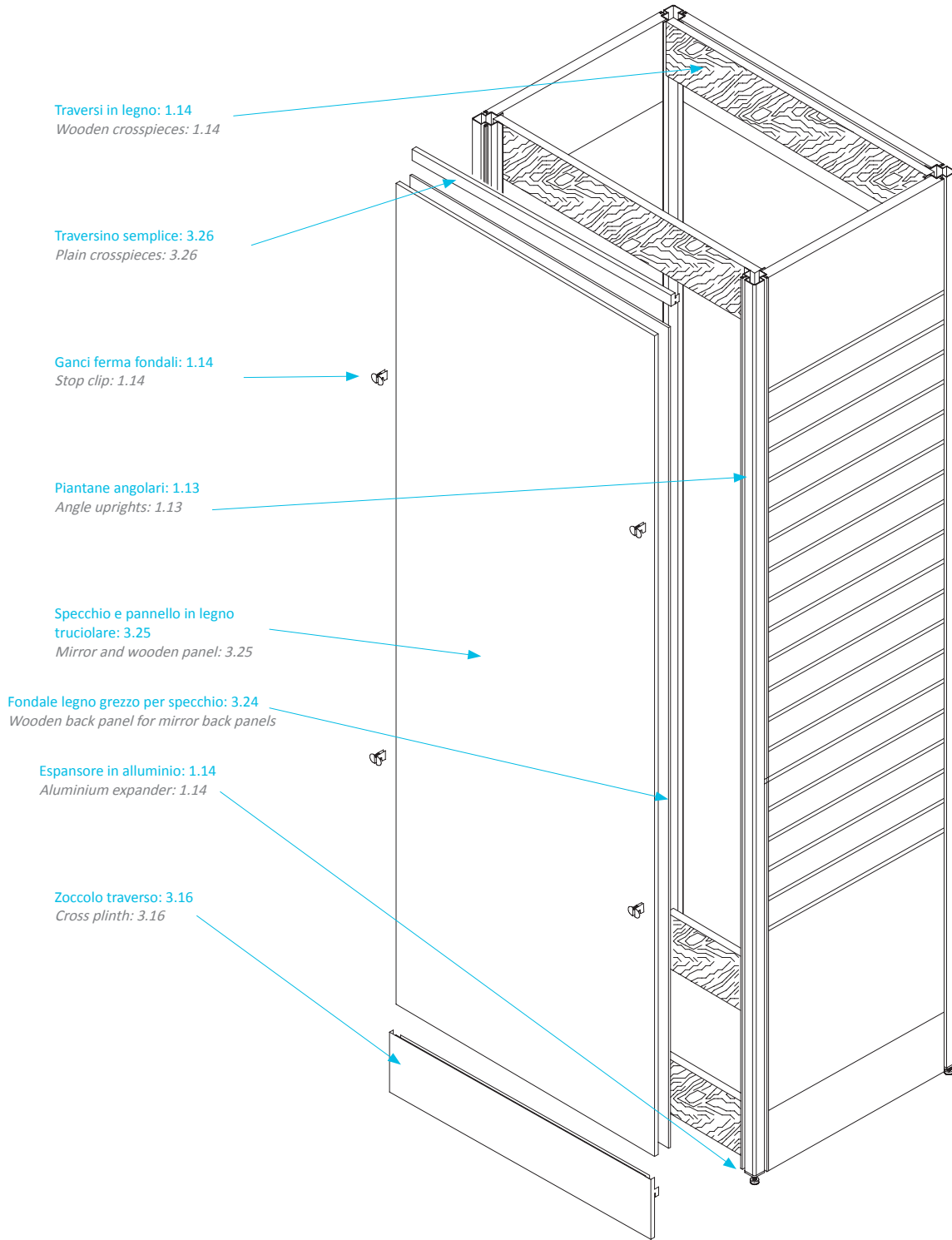

dimensione pilastro (L) = passo - 5 cm  
pillar dimension (L) = bay - 5 cm

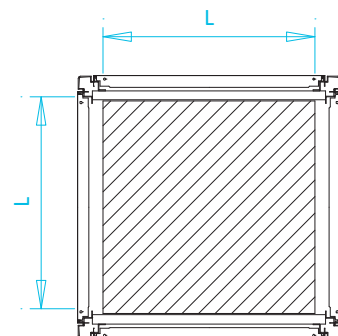

Piantane Uprights

1.13

Piantana angolare per rivestimento pilastri  
Angle uprights for pillar facing

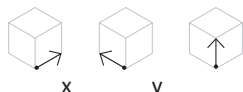

x	y	z	codice code	note notes
--	--	299	50.-46	
--	--	327	50.-45	

finitura finish	colori colours
V	2004
	6018
	6027
	• 7035
	AMA
	• ANT
	AZZ
	1001
	• BIA
	BLU
	GIA
	MAR
	• MTZ
	• PAN
	RO3
	BIMCL
	NRMCL
	• OXI

Accessori per Piantane Upright Accessories

1.14

Elementi specifici per piantana angolare  
Fixing accessories for angle uprights

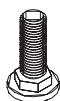
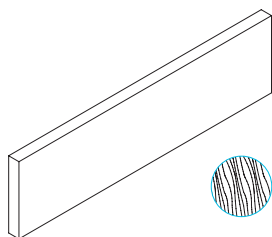
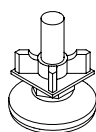

Espansore in alluminio  
Aluminium expander

codice code	finitura e colore finish & colour
12.-34	N

Gancio ferma fondali / traversi in legno  
Stop clip for tailored back panels / crosspieces

34.308	C
--------	---

Traverso in legno y=2 z= 13 cm  
Wooden crosspiece y=2 z= 13 cm

x=50	20.186	G
x=75	20.185	G
x=100	20.184	G

Piedino regolatore  
Wooden crosspiece y=2 z= 4 cm

FE.-11	
--------	--

**note**  
*notes*

# Basi *Bases*

# 2

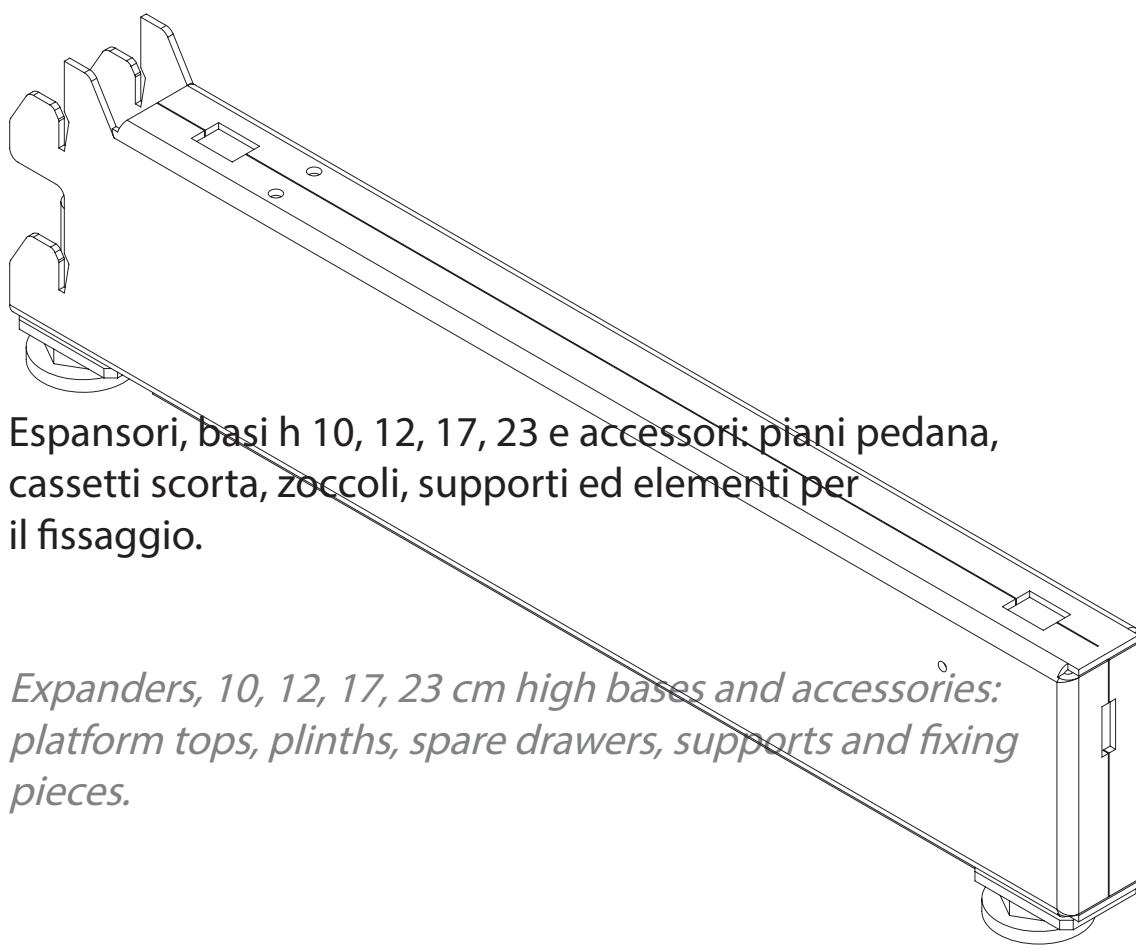

Espansori, basi h 10, 12, 17, 23 e accessori: piani pedana, cassette scorta, zoccoli, supporti ed elementi per il fissaggio.

*Expanders, 10, 12, 17, 23 cm high bases and accessories: platform tops, plinths, spare drawers, supports and fixing pieces.*





1 Prolunga  
*Extension*

2 Piantane  
*Uprights*

3 Base h 10 e supporti  
*10 cm high base and supports*

4 Base h 17 /23 cm  
*17/23 cm high bases*

5 Espansore  
*Expander*

6 Base h12 extrabassa / h12 extrastlim  
*12 cm low base and cap*

7 Supporto piano base per base h 10  
*Supports for base shelf for 10 cm high bases*

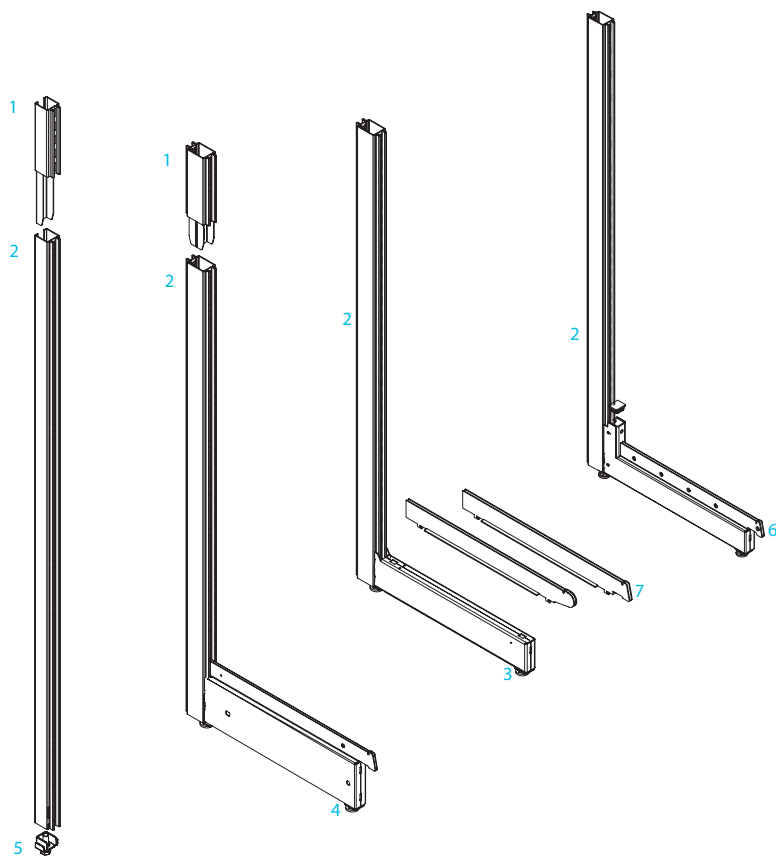

1

Svitare il bullone per l'inserimento degli agganci della base nelle cave inferiori della piantana.  
*To allow the base and the upright connection please unscrew a little the expander.*

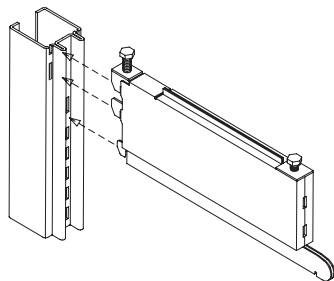

2

Inserita la base nella piantana, riavvitare il bullone ed agganciare con forza fino alla fine della corsa degli agganci.  
*Take the upright and the base, and hook them together. When hooked, screw again the expander.*

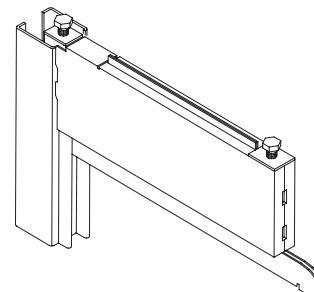

Supporto con due ruote: 2.22  
*Support with wheels: 2.22*

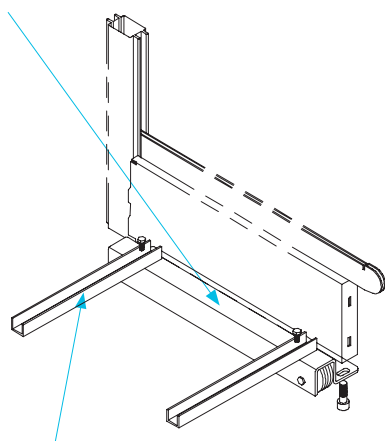

Traverso profilato a U con viti di fissaggio: 2.22  
*U shaped crosspiece with screws: 2.22*

Ruote: 2.22  
*Wheels: 2.22*

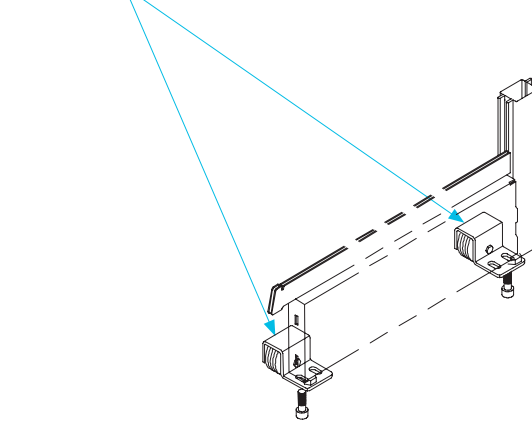

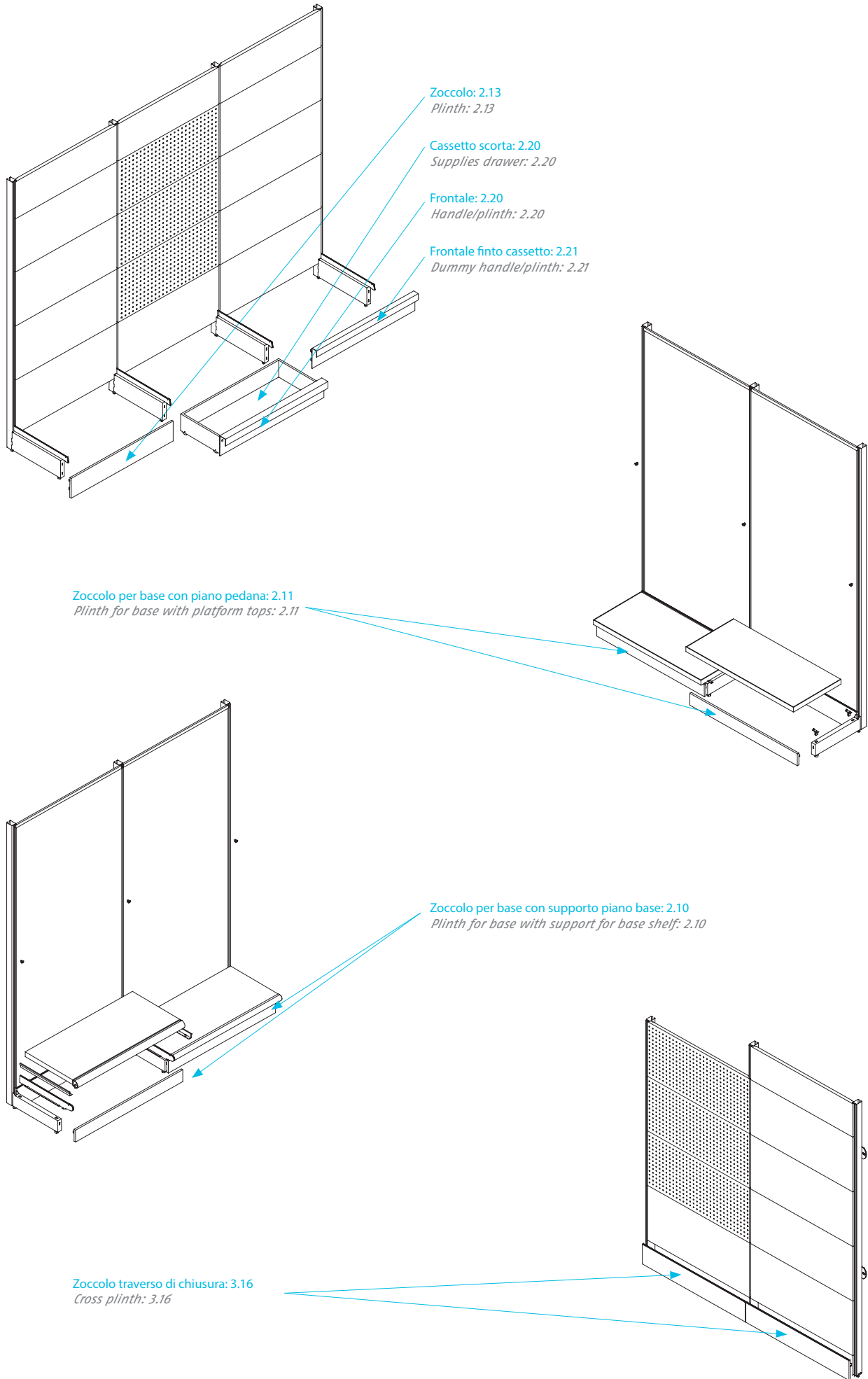



Espansori  
Expanders

2.1

Espansore in acciaio per piantane tubolari  
Steel expander for tubular uprights

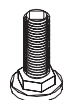
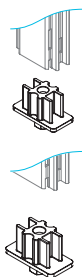

	x	y	z	codice code	finitura e colore finish & colour	note notes
piantana upright y=7,2	3,7	7,2	--	12.-29	N	
piantana upright y=9	3,7	9	--	12.-30	N	

Zoccolo traverso: 3.16  
Piantane tubolari: 1.1  
e 1.3  
Cross plinth: 3.16  
Tubular upright: 1.1  
and 1.3

codice code	finitura e colore finish & colour
FE.-12	

Piedino regolatore

Wooden crosspiece y=2 z= 13 cm



Espansori  
Expanders

2.2

Espansore in acciaio per piantane a parete  
Steel expander for wall uprights

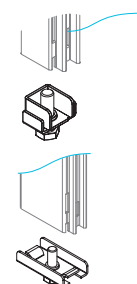

	x	y	z	codice code	finitura e colore finish & colour	note notes
piantana upright y=5	3,7	5	--	12.-04	C	
piantana upright y=9	3,7	9	--	12.-10	C	

Zoccolo traverso: 3.16  
Piantane a parete: 1.5  
Cross plinth: 3.16  
Wall upright: 1.5

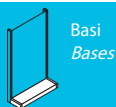

Basi  
Bases

2.3

Basi h 17  
17 cm high bases

				codice code	note notes	finitura finish	colori colours																						
 testa inclinata <i>sloped head</i>	--	30	17	11.-62		<table border="1"> <thead> <tr><th>V</th></tr> </thead> <tbody> <tr><td>2004</td></tr> <tr><td>6018</td></tr> <tr><td>6027</td></tr> <tr><td>• 7035</td></tr> <tr><td>AMA</td></tr> <tr><td>• ANT</td></tr> <tr><td>AZZ</td></tr> <tr><td>1001</td></tr> <tr><td>• BIA</td></tr> <tr><td>BLU</td></tr> <tr><td>GIA</td></tr> <tr><td>MAR</td></tr> <tr><td>• MTZ</td></tr> <tr><td>• PAN</td></tr> <tr><td>RO3</td></tr> <tr><td>BIMCL</td></tr> <tr><td>NRMCL</td></tr> <tr><td>• OXI</td></tr> </tbody> </table>	V	2004	6018	6027	• 7035	AMA	• ANT	AZZ	1001	• BIA	BLU	GIA	MAR	• MTZ	• PAN	RO3	BIMCL	NRMCL	• OXI				
	V																												
	2004																												
	6018																												
	6027																												
	• 7035																												
AMA																													
• ANT																													
AZZ																													
1001																													
• BIA																													
BLU																													
GIA																													
MAR																													
• MTZ																													
• PAN																													
RO3																													
BIMCL																													
NRMCL																													
• OXI																													
--	40	17	11.-31																										
--	50	17	11.-32																										
--	60	17	11.-33																										
--	70	17	11.-34																										
--	80	17	11.-35																										
 testa tonda <i>rounded head</i>	--	30	17	11.-41																									
	--	40	17	11.-42																									
	--	50	17	11.-43																									
	--	60	17	11.-44																									
	--	70	17	11.-45																									
	--	80	17	11.-46																									
 testa diritta <i>straight head</i>	--	30	17	11.115																									
	--	40	17	11.-96																									
	--	50	17	11.-95																									

Per piani legno: 2.9.1  
For wooden shelves: 2.9.1



Basi  
Bases

2.4

Basi h 23  
23 cm high bases

				codice code	note notes	finitura finish	colori colours																						
 testa inclinata <i>sloped head</i>	--	30	23	11.-70		<table border="1"> <thead> <tr><th>V</th></tr> </thead> <tbody> <tr><td>2004</td></tr> <tr><td>6018</td></tr> <tr><td>6027</td></tr> <tr><td>• 7035</td></tr> <tr><td>AMA</td></tr> <tr><td>• ANT</td></tr> <tr><td>AZZ</td></tr> <tr><td>1001</td></tr> <tr><td>• BIA</td></tr> <tr><td>BLU</td></tr> <tr><td>GIA</td></tr> <tr><td>MAR</td></tr> <tr><td>• MTZ</td></tr> <tr><td>• PAN</td></tr> <tr><td>RO3</td></tr> <tr><td>BIMCL</td></tr> <tr><td>NRMCL</td></tr> <tr><td>• OXI</td></tr> </tbody> </table>	V	2004	6018	6027	• 7035	AMA	• ANT	AZZ	1001	• BIA	BLU	GIA	MAR	• MTZ	• PAN	RO3	BIMCL	NRMCL	• OXI				
	V																												
	2004																												
	6018																												
	6027																												
	• 7035																												
AMA																													
• ANT																													
AZZ																													
1001																													
• BIA																													
BLU																													
GIA																													
MAR																													
• MTZ																													
• PAN																													
RO3																													
BIMCL																													
NRMCL																													
• OXI																													
--	40	23	11.-36																										
--	50	23	11.-37																										
--	60	23	11.-38																										
--	70	23	11.-39																										
--	80	23	11.-40																										



Basi  
Bases

2.5

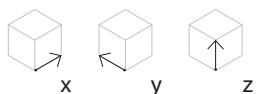
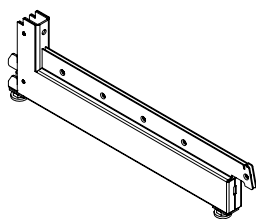
Basi Extrabassa h 12  
12 cm low basestesta inclinata  
*sloped head*

	x	y	z	codice code	note notes	finitura finish	colori colours	colori colours
	--	43	12	11.-93		V		
	--	53	12	11.-90			2004	MAR
	--	63	12	11.-91			6018	• MTZ
	--	73	12	11.114			6027	• PAN
	--	83	12	11.-94			• 7035	RO3
							AMA	BIMCL
							• ANT	NRMCL
							AZZ	• OXI
							1001	
							• BIA	
							BLU	
							GIA	
Tappo x base <i>Based cap</i>	3	3	1,7	CP.100				
	3	3	1,7	CP.100	TNER			

**CP.100**Colorazione neutra opacizzata  
Neutral color mattBasi  
Bases

2.6

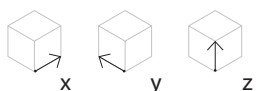
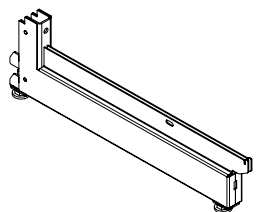
Basi Extra Slim h 12  
12 cm Extraslim low basestesta diritta  
*ExtraSlim head*

	x	y	z	codice code	note notes	finitura finish	colori colours	colori colours
	--	43	12	11.103		V		
	--	53	12	11.-97			2004	MAR
	--	63	12	11.-98			6018	• MTZ
	--	73	12	11.-99			6027	• PAN
	--	83	12	11.102			• 7035	RO3
							AMA	BIMCL
							• ANT	NRMCL
							AZZ	• OXI
							1001	
							• BIA	
							BLU	
							GIA	
Tappo x base <i>Based cap</i>	3	3	1,7	CP.100				
	3	3	1,7	CP.100	TNER			

**CP.100**Colorazione neutra opacizzata  
Neutral color mattBasi  
Bases

2.7

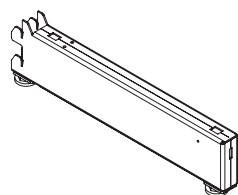
Basi a 1 dente d'aggancio h 10  
10 cm high bases with one hooking prong

	x	y	z	codice code	note notes	finitura finish	colori colours	colori colours
	--	30	10	11.-84		V		
	--	40	10	11.-51			2004	MAR
	--	50	10	11.-52			6018	• MTZ
	--	60	10	11.-59			6027	• PAN
							• 7035	RO3
							AMA	BIMCL
							• ANT	NRMCL
							AZZ	• OXI
							1001	
							• BIA	
							BLU	
							GIA	

**Pannello trasverso: 3.15**

Lower plinth: 3.15

Accessori per Basi  
Base Accessories

2.8

Supporto piano base per base h 10  
Supports for base shelf for 10 cm high bases

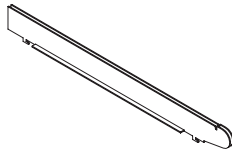
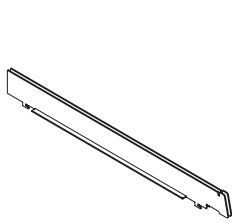

	x	y	z	codice code	note notes	finitura finish	colori colours
testa inclinata sloped head	--	30	--	11.105		V	2004
	--	40	--	11.-64			6018
	--	50	--	11.-65			6027
	--	60	--	11.-66			• 7035
testa tonda round head	--	40	--	11.-54			AMA
	--	50	--	11.-56			• ANT
	--	60	--	11.-60			AZZ
							1001
							• BIA
					BLU		
					• GIA		
					MAR		
					• MTZ		
					• PAN		
					RO3		
					BIMCL		
					NRMCL		
					• OXI		

Accessori per Basi  
Base Accessories

2.9

Piano pedana legno per basi H 10  
Platform wooden tops for h 10 low bases

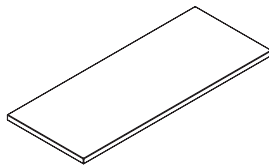

	x	y	z	codice code	note notes	finitura finish	colori colours	colori colours
base base z=10	50	40	2,5	17.662		T	7035	A838
	75	40	2,5	17.659			• ACE	999XA
	100	40	2,5	17.656			• BIA	995XM
base base z=10							• FAG	989XR
							• MTZ	994XS
							• PAN	997XS
							• A439	983XR
							• ANT	984XA
							K101	BLACK
base base z=10	50	50	2,5	17.663			3813	GREEN
	75	50	2,5	17.660			2293	BEIGE
	100	50	2,5	17.657			990XA	WHITE
					990XM			
base base z=10	50	60	2,5	17.664				
	75	60	2,5	17.661				
	100	60	2,5	17.658				

Fermo per piano pedana per base h 10  
Support for platform tops



Fermo centrale ant./post. x=5,8 z=2,5 cm  
Front/back support for consecutive tops

codice  
code  
11.-71  
finitura e  
colore  
finitura &  
colour  
C

Fermo laterale ant./post. x=4 z=2,5 cm  
Front/back support for ending tops

11.-72 C

Accessori per Basi  
Base Accessories

## 2.9.1

Piano pedana legno per basi slim H 17 c/supporti alluminio  
Platform wooden tops with aluminium supports for 17 h slim bases

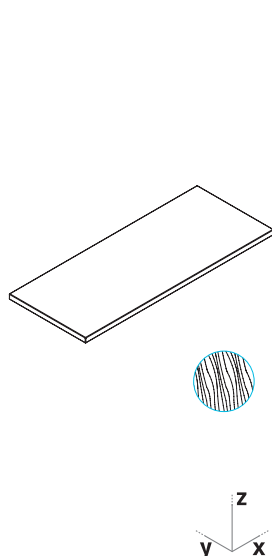

	x	y	z	codice code	note notes	finitura finish	colori colours
base slim slim base z=17	50	31	2,5	40.196		T	7035
	75	31	2,5	40.197			ACE
	100	31	2,5	40.198			BIA
base slim slim base z=17	50	41	2,5	40.199			FAG
	75	41	2,5	40.200			MTZ
	100	41	2,5	40.201			PAN
							A439
							ANT
							K101
base slim slim base z=17	50	51	2,5	40.202			3813
	75	51	2,5	40.203			2293
	100	51	2,5	40.204			990XA
							990XM
						A838	
						999XA	
						995XM	
						989XR	
						994XS	
						997XS	
						983XR	
						984XA	
						BLACK	
						GREEN	
						BEIGE	
						WHITE	

Accessori per Basi  
Base Accessories

## 2.10

Zoccolo per base h 10 con supporto piano base  
Plinth for 10 cm high bases with support for base shelf

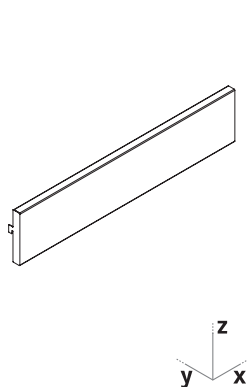

	x	y	fz	codice code	note notes	finitura finish	colori colours
base base z=10	50	--	10,5	15.176		P	V
	75	--	10,5	15.175			2004
	100	--	10,5	15.174			6018
							6027
							7035
							AMA
							ANT
							AZZ
							1001
							BIA
							BLU
							GIA
							MAR
							MTZ
							PAN
							RO3
							BIMCL
							NRMCL
							OXI

Supporto piano base: 2.8  
Supports for base shelf: 2.8

Accessori per Basi  
Base Accessories

2.11

Zoccolo per base h 10 con piano pedana  
Plinth for 10 cm high bases with platform tops

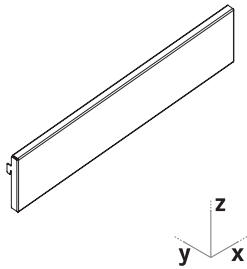

	x	y	z	codice code	note notes
base base z=10	50	--	8,8	15.179	
	75	--	8,8	15.178	
	100	--	8,8	15.177	

Piano pedana: 2.9  
Platform top: 2.9

finitura finish	colori colours
P	V
	2004
	6018
	6027
•	7035
	AMA
•	ANT
	AZZ
	1001
•	BIA
	BLU
	GIA
	MAR
•	MTZ
•	PAN
	RO3
	BIMCL
	NRMCL
•	OXI

Accessori per Basi  
Base Accessories

2.12

Zoccolo per basi h 12 Extrabassa ed Extra Slim  
Plinth for 12 cm extra-low and extra-slim bases

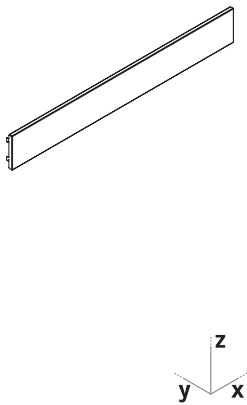

	x	y	z	codice code	note notes
base base z=12	66,5	--	8	15.254	
	100	--	8	15.251	
	133	--	8	15.253	

finitura finish	colori colours
	V
	2004
	6018
	6027
•	7035
	AMA
•	ANT
	AZZ
	1001
•	BIA
	BLU
	GIA
	MAR
•	MTZ
•	PAN
	RO3
	BIMCL
	NRMCL
•	OXI



Accessori per Basi  
Base Accessories

## 2.13

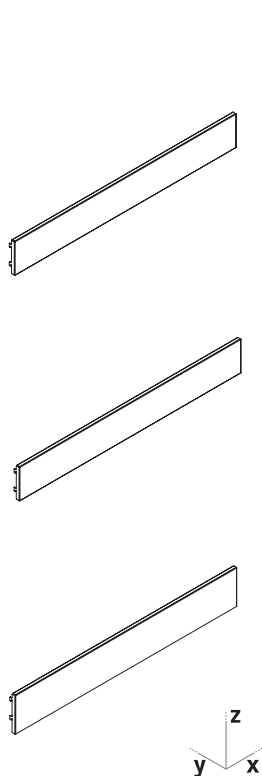
Zoccolo per basi h 17/15/23 Fascia Cielino  
Plinth for 17/15/23 cm / Canopy Front

	x	y	z	codice code	note notes	finitura finish	colori colours																																					
base base z=17	50	--	13	15.129		<table border="1"> <thead> <tr> <th>P</th> <th>V</th> </tr> </thead> <tbody> <tr><td></td><td>2004</td></tr> <tr><td></td><td>6018</td></tr> <tr><td></td><td>6027</td></tr> <tr><td>•</td><td>7035</td></tr> <tr><td></td><td>AMA</td></tr> <tr><td>•</td><td>ANT</td></tr> <tr><td></td><td>AZZ</td></tr> <tr><td></td><td>1001</td></tr> <tr><td>•</td><td>BIA</td></tr> <tr><td></td><td>BLU</td></tr> <tr><td></td><td>GIA</td></tr> <tr><td></td><td>MAR</td></tr> <tr><td>•</td><td>MTZ</td></tr> <tr><td></td><td>PAN</td></tr> <tr><td></td><td>RO3</td></tr> <tr><td></td><td>BIMCL</td></tr> <tr><td></td><td>NRMCL</td></tr> <tr><td>•</td><td>OXI</td></tr> </tbody> </table>	P	V		2004		6018		6027	•	7035		AMA	•	ANT		AZZ		1001	•	BIA		BLU		GIA		MAR	•	MTZ		PAN		RO3		BIMCL		NRMCL	•	OXI
	P	V																																										
		2004																																										
		6018																																										
		6027																																										
•	7035																																											
	AMA																																											
•	ANT																																											
	AZZ																																											
	1001																																											
•	BIA																																											
	BLU																																											
	GIA																																											
	MAR																																											
•	MTZ																																											
	PAN																																											
	RO3																																											
	BIMCL																																											
	NRMCL																																											
•	OXI																																											
66,5	--	13	15.-83																																									
75	--	13	15.128																																									
100	--	13	15.-82																																									
133	--	13	15.-84																																									
base base z=15	50	--	15	15.258	base testa diritta																																							
	75	--	15	15.256	base testa diritta																																							
	100	--	15	15.257	base testa diritta																																							
base base z=23	50	--	17	15.136																																								
	66,5	--	17	15.-80																																								
	75	--	17	15.135																																								
	100	--	17	15.-79																																								
	133	--	17	15.-81																																								

Accessori per Basi  
Base Accessories

## 2.14

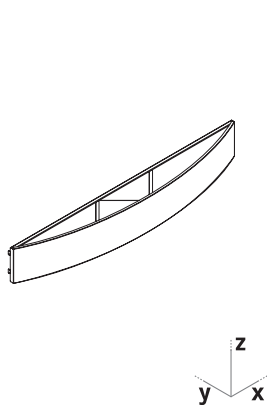
Zoccolo curvo per basi h 12/17  
Curved plinth for 12/17 cm bases

	x	y	z	codice code	note notes	finitura finish	colori colours																																					
base base z=12	100	--	8	15.237		<table border="1"> <thead> <tr> <th>P</th> <th>V</th> </tr> </thead> <tbody> <tr><td></td><td>2004</td></tr> <tr><td></td><td>6018</td></tr> <tr><td></td><td>6027</td></tr> <tr><td>•</td><td>7035</td></tr> <tr><td></td><td>AMA</td></tr> <tr><td>•</td><td>ANT</td></tr> <tr><td></td><td>AZZ</td></tr> <tr><td></td><td>1001</td></tr> <tr><td>•</td><td>BIA</td></tr> <tr><td></td><td>BLU</td></tr> <tr><td></td><td>GIA</td></tr> <tr><td></td><td>MAR</td></tr> <tr><td>•</td><td>MTZ</td></tr> <tr><td>•</td><td>PAN</td></tr> <tr><td></td><td>RO3</td></tr> <tr><td></td><td>BIMCL</td></tr> <tr><td></td><td>NRMCL</td></tr> <tr><td>•</td><td>OXI</td></tr> </tbody> </table>	P	V		2004		6018		6027	•	7035		AMA	•	ANT		AZZ		1001	•	BIA		BLU		GIA		MAR	•	MTZ	•	PAN		RO3		BIMCL		NRMCL	•	OXI
	P	V																																										
	2004																																											
	6018																																											
	6027																																											
•	7035																																											
	AMA																																											
•	ANT																																											
	AZZ																																											
	1001																																											
•	BIA																																											
	BLU																																											
	GIA																																											
	MAR																																											
•	MTZ																																											
•	PAN																																											
	RO3																																											
	BIMCL																																											
	NRMCL																																											
•	OXI																																											
133	--	8	15.236																																									
base base z=17	100	--	13	15.138																																								
	133	--	13	15.137																																								

2.15

Zoccolo angolo chiuso per basi h 17/23  
Closed corner plinth for 17/23 cm bases

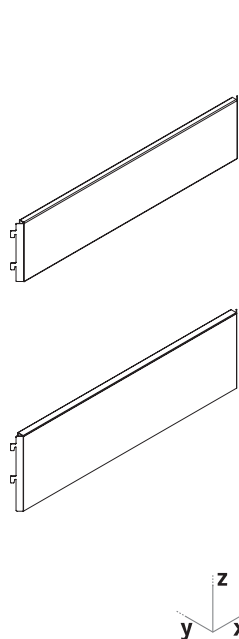

	x	yz		codice code	note notes
base base z=17	30	--	13	15.148	usare con fondale curvo e piano in legno
	40	--	13	15.149	
	50	--	13	15.150	
	60	--	13	15.151	
base base z=23	30	--	17	15.294	usare con fondale a 90° e piani in metallo
	40	--	17	15.295	
	50	--	17	15.296	
	60	--	17	15.297	
base base z=23	30	--	17	15.152	
	40	--	17	15.153	
	50	--	17	15.154	
	60	--	17	15.155	

finitura finish	colori colours
P	V
	2004
	6018
	6027
•	7035
	AMA
	• ANT
	AZZ
	1001
•	BIA
	BLU
	GIA
	MAR
•	• MTZ
•	PAN
	RO3
	BIMCL
	NRMCL
	• OXI

2.16

Zoccolo angolo aperto per basi h 17/ 23  
Open corner plinth for 17/23 cm bases

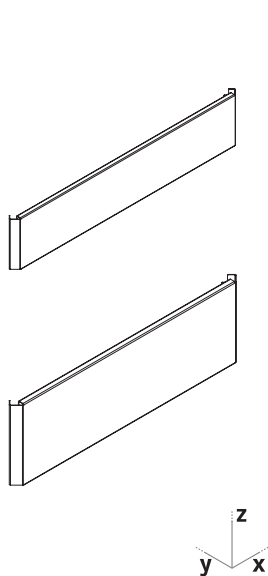

	x	y	z	codice code	note notes
base base z=17	30	--	13	15.156	
	40	--	13	15.157	
	50	--	13	15.158	
	60	--	13	15.159	
base base z=23	30	--	17	15.160	
	40	--	17	15.161	
	50	--	17	15.162	
	60	--	17	15.163	

finitura finish	colori colours
P	V
	2004
	6018
	6027
•	7035
	AMA
	• ANT
	AZZ
	1001
•	BIA
	BLU
	GIA
	MAR
•	• MTZ
•	PAN
	RO3
	BIMCL
	NRMCL
	• OXI

Accessori per Basi  
Base Accessories

2.17

Zoccolo angolo chiuso per basi h 12  
*Closed corner plinth for 12 cm bases*

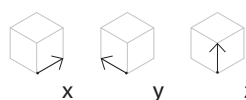
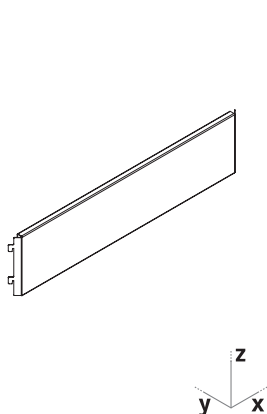

	x	y	z	codice code	note notes
	40	--	8	15.240	
	50	--	8	15.241	
	60	--	8	15.242	

finitura finish	colori colours
V	2004
	6018
	6027
•	7035
	AMA
•	ANT
	AZZ
	1001
•	BIA
	BLU
	GIA
	MAR
•	MTZ
•	PAN
	RO3
	BIMCL
	NRMCL
•	OXI

Accessori per Basi  
Base Accessories

2.18

Zoccolo angolo aperto per basi h 12  
*Open corner plinth for 12 cm bases*

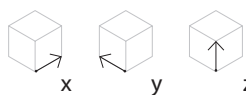
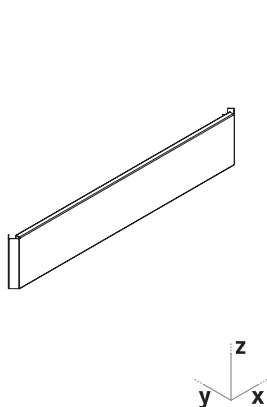

	x	y	z	codice code	note notes
	40	--	8	15.272	
	50	--	8	15.273	
	60	--	8	15.274	

finitura finish	colori colours
V	2004
	6018
	6027
•	7035
	AMA
•	ANT
	AZZ
	1001
•	BIA
	BLU
	GIA
	MAR
•	MTZ
•	PAN
	RO3
	BIMCL
	NRMCL
•	OXI

Accessori per Basi  
Base Accessories

2.19

Cassetto scorta senza frontale in metallo per basi h 17 e h 23  
*Metal supplies drawer with wheels, without handle/plinth*

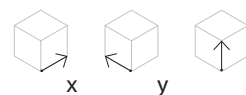
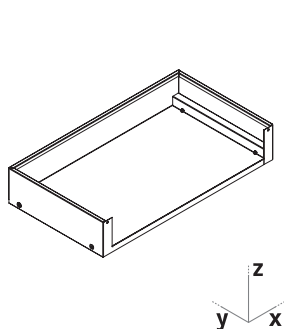

	x	y	z	codice code	note notes
	71	39	--	15.180	
	96	39	--	15.164	
	129	39	--	15.182	

finitura finish	colori colours
V	BIA

2.20

Frontale metallo con maniglia per cassetto  
Handle/plinth for metal supplies drawer

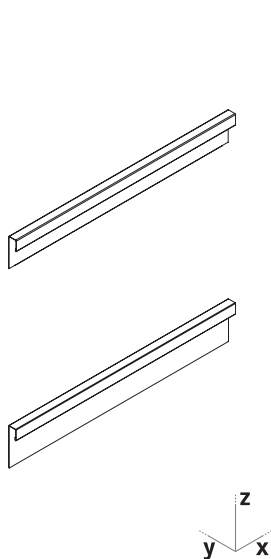

	x	y	z	codice code	note notes
base base z=17	75	--	13	15.206	
	100	--	13	15.165	
	133	--	13	15.183	
base base z=23	75	--	17	15.181	
	100	--	17	15.166	
	133	--	17	15.196	

Cassetto scorta, vedi 2.19  
Supplies drawer, see 2.19

finitura finish	colori colours
V	
	2004
	6018
	6027
	• 7035
	AMA
	• ANT
	AZZ
	1001
	• BIA
	BLU
	GIA
	MAR
	• MTZ
	• PAN
	RO3
	BIMCL
	NRMCL
	• OXI

2.21

Frontale finto cassetto in metallo per basi h 17 e h 23  
Dummy handle/plinth for 17/23 cm high bases

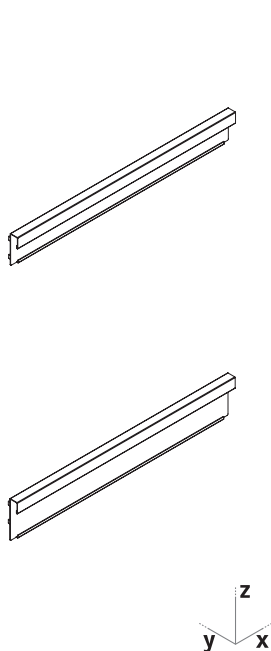

	x	y	z	codice code	note notes
base base z=17	50	--	13	15.169	
	66,5	--	13	15.211	
	75	--	13	15.168	
	100	--	13	15.167	
	133	--	13	15.210	
base base z=23	50	--	17	15.172	
	66,5	--	17	15.209	
	75	--	17	15.171	
	100	--	17	15.170	
	133	--	17	15.173	

finitura finish	colori colours
V	
	2004
	6018
	6027
	• 7035
	AMA
	• ANT
	AZZ
	1001
	• BIA
	BLU
	GIA
	MAR
	• MTZ
	• PAN
	RO3
	BIMCL
	NRMCL
	• OXI

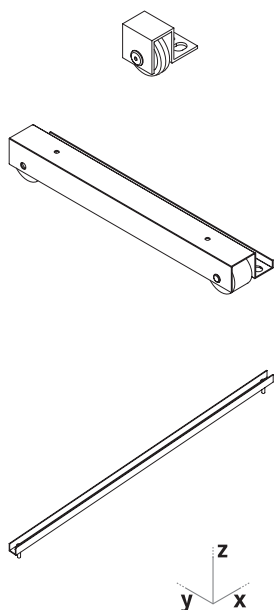
Ruota  
*Wheel*

codice code	finitura e colore finish & colour
12.-05	C

Supporto con due ruote  
*Support with wheels*

y=40	34.499	C
y=50	34.131	C
y=60	34.150	C

Traverso profilato a U con viti di fissaggio  
*U shaped crosspiece with screws*

x=96	34.132	C
x=71	34.322	C

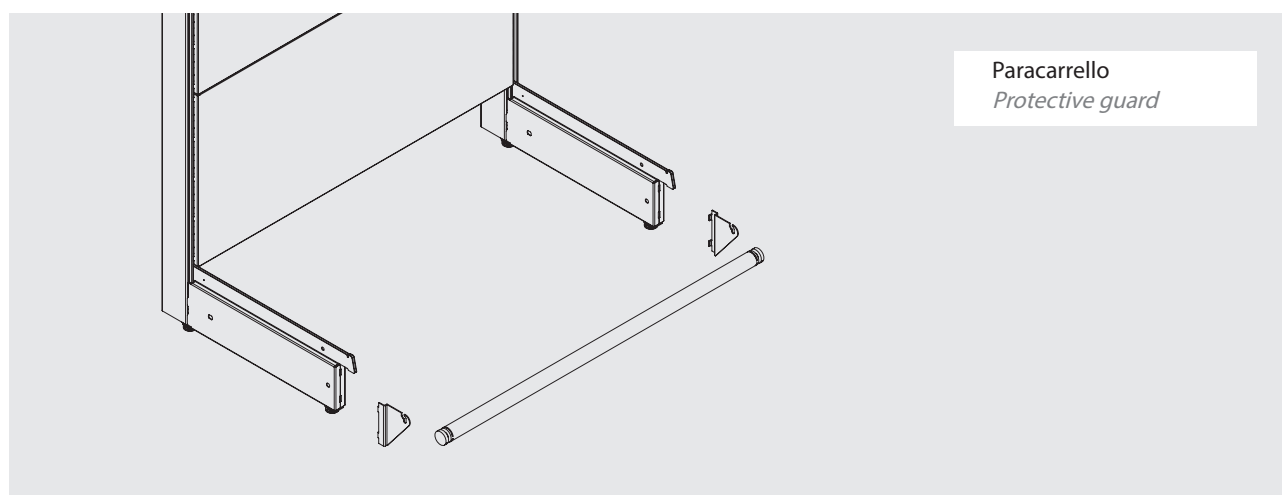
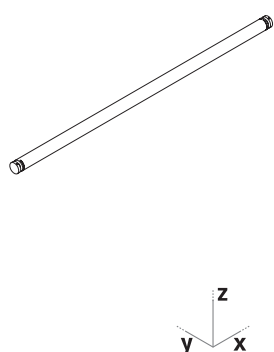
Paracarrello  
*Protective guard*Traverso paracarrello  
*Crosspiece for protective guard*

x=50	34.398	C
x=66,5	34.236	C
x=75	34.397	C
x=100	34.235	C
x=133	34.237	C

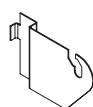
Supporto per traverso paracarrello  
*Support for protective guard*Base h 12

dx rh	34.607	C
sx lh	34.606	C

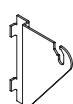
Base h 17/23

dx rh	34.246	C
sx lh	34.247	C

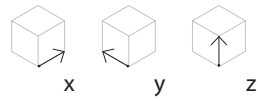
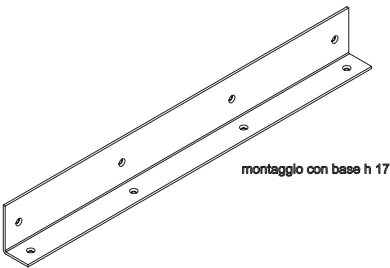
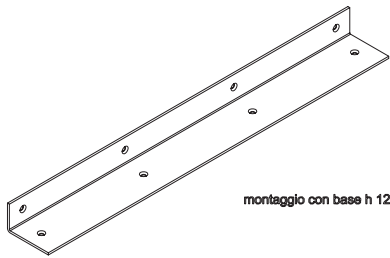

x	y	z	codice code	note notes
125	9	15	18.324	

finitura finish	colori colours
V	MTZ

Per il fissaggio dell'elemento prevedere:  
Nr. 4 FE.189  
Nr. 4 FE.190

For fixing add:  
nr. 4 FE.189  
nr. 4 FE.190

# Gondole carrellate

## Gondola units with wheels

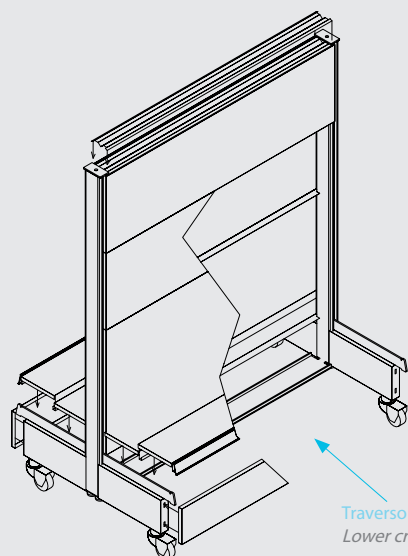

Gondola carrellata  
Gondola with

Traverso inferiore: 2.24  
Lower crosspiece: 2.24

Accessori per Basi  
Base Accessories

2.24

Traverso inferiore per gondola singola con ruote  
Lower crosspiece for single gondola unit with wheels

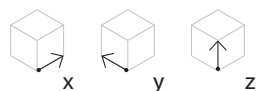
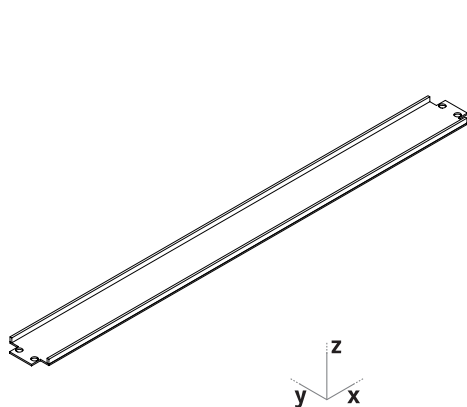

x	y	z	codice code	note notes
66,5	8	2	34.685	
75	8	2	34.682	
100	8	2	34.684	
133	8	2	34.719	

finitura finish	colori colours
V	
•	BIA
	--

Disponibile solo per  
montante da 7,2 cm  
CAP. 1.1

It could be used only with  
7,2 cm upright  
CHA. 1.1

Non usare con moduli  
consecutivi e altezze  
superiori a 158 cm

Available only for single  
element and h 158 cm  
upright

Accessori per Basi  
Base Accessories

2.25

Traverso superiore per gondole carrellate  
Upper frame for any gondola units

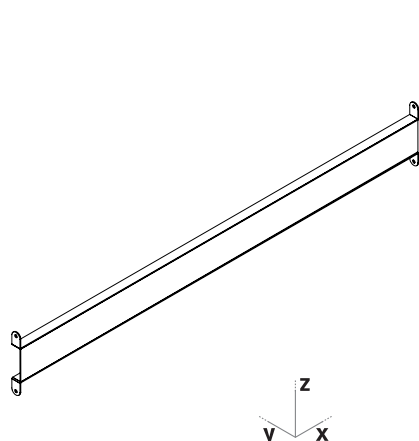

x	y	z	codice code	note notes
50	-	7,6	14.-62	
66,5	-	7,6	14.-63	
75	-	7,6	14.-61	
100	-	7,6	14.-60	
133	-	7,6	14.-64	

finitura finish	colori colours
V	
•	BIA
	--

Prevedere nr. 4 viti 34.521C ogni traverso - CAP. 1.8  
Use nr 4 34.521C for each upper frame - CHA. 1.8

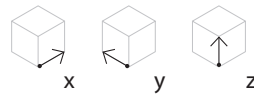
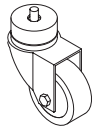
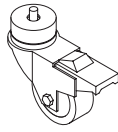

	x	y	z	codice code	note notes
	2,5	5	5	12.-69	s/freno
	2,5	5	5	12.-68	c/freno

finitura finish	colori colours
T	
•	GRI
	--



**note**  
*notes*

**note**  
*notes*

# Fondali

## *Back panels*

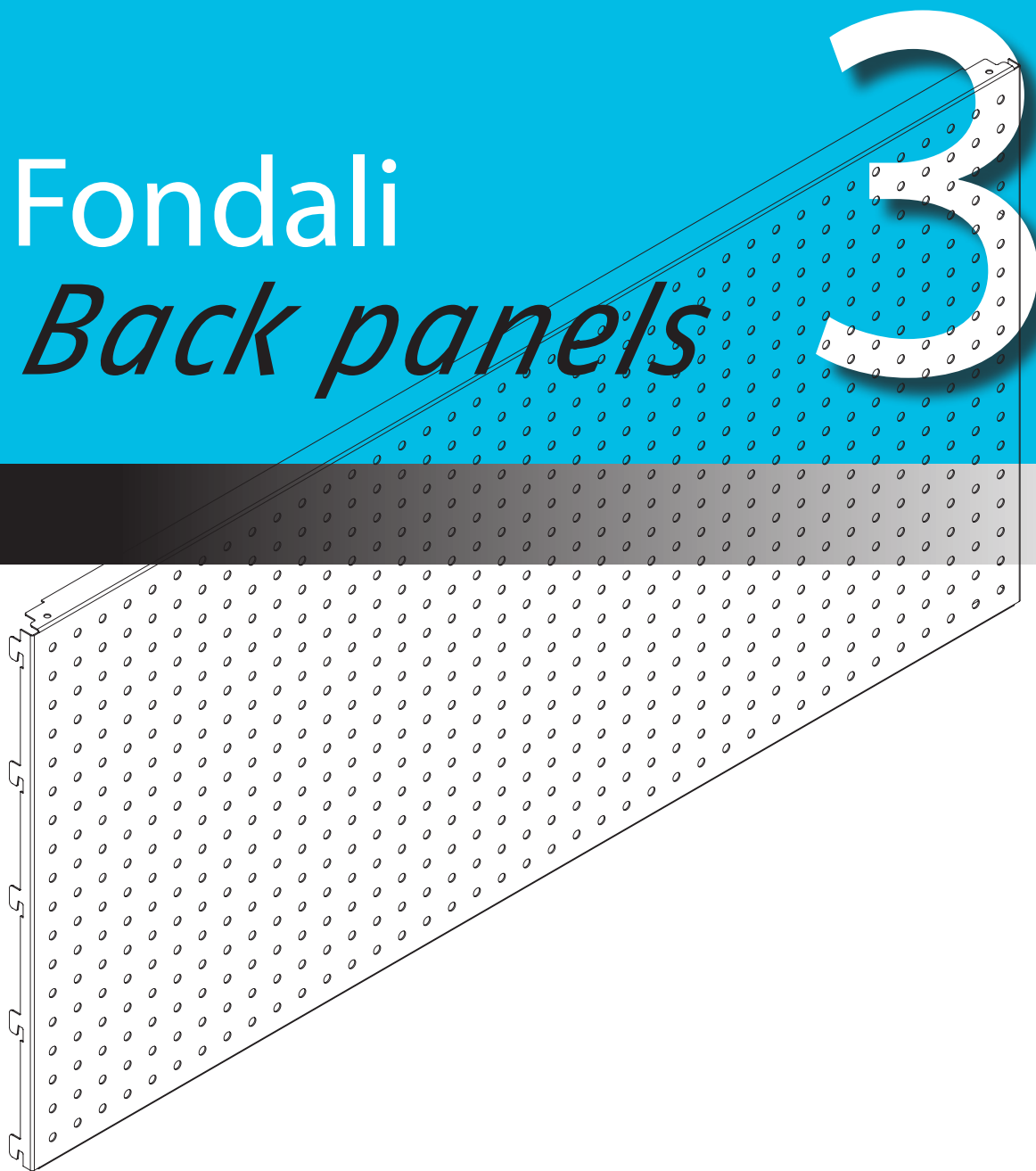

Pannelli di fondale in acciaio lisci, forati, asolati, a cornice, a feritoie, dogati, pannelli in legno, fondali a specchio e accessori: coperchi, supporti ed elementi per il fissaggio.

*Back steel panels, perforated panels, slotted panels, slitted panels, frame panels, slatted panels, wooden panels, mirror panels and accessories: top closers, supports and fixing pieces.*



## Composizione a parete continua di elementi ad angolo aperto e chiuso curvo con basi h 17/23

Wall units with curved open and close corner elements

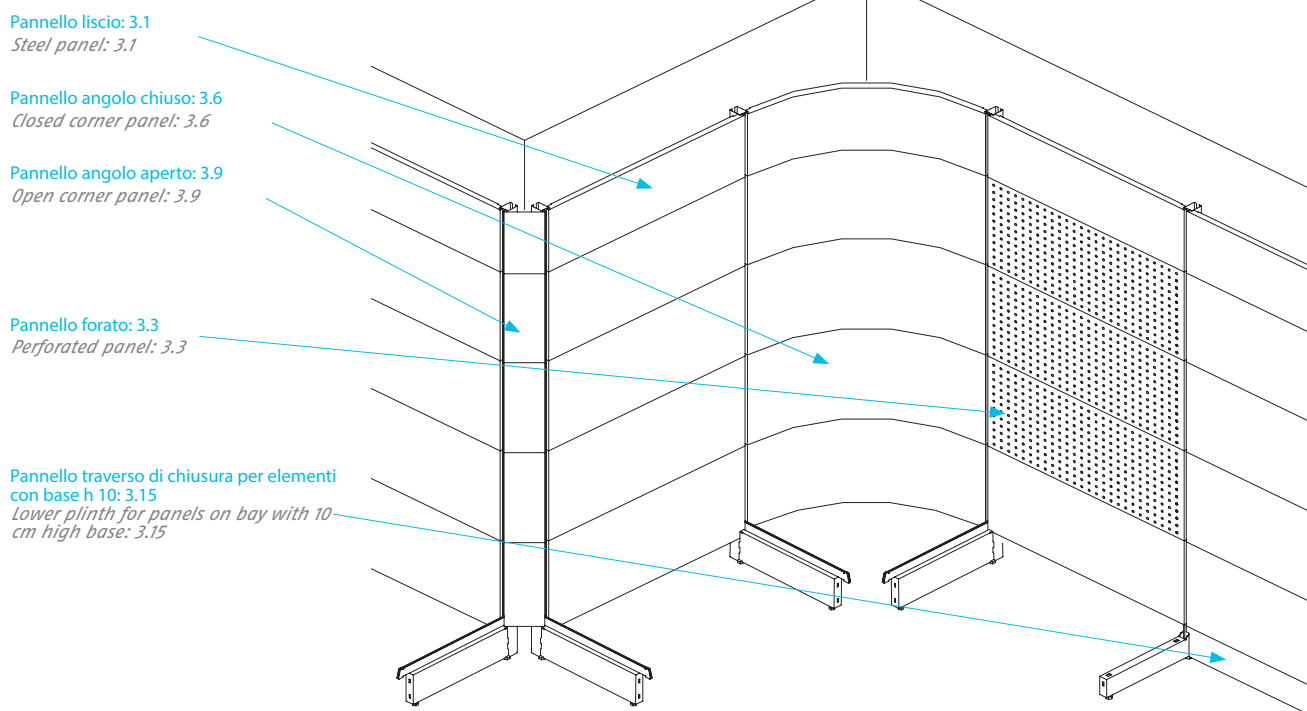

### Pannello e zoccolo traverso

Cross and lower plinth

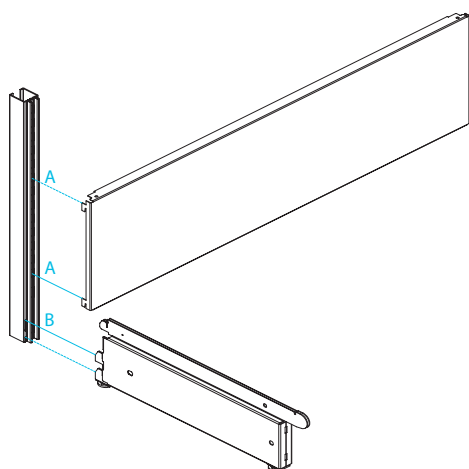

**A** Cava di partenza per l'aggancio dei pannelli di fondale  
Starting upright slot for back panels fixing

**B** Cava di partenza per l'aggancio superiore della base h 17  
Starting upright slot for 17 cm high base fixing

**C** Cava di partenza per l'aggancio dello zoccolo traverso, per elementi con espansore  
Starting upright slot for cross plinth fixing, for elements with expander

**D** Cava di partenza per l'aggancio del pannello traverso, per elementi con base h 10  
Starting upright slot for lower plinth fixing, for elements with 10 cm high base

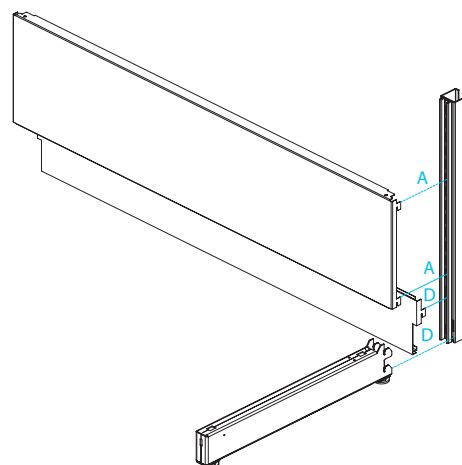
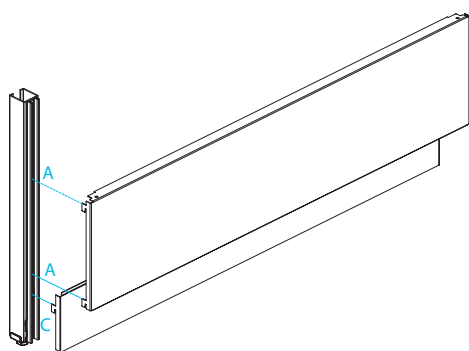

Composizione a parete continua di elementi in metallo ad angolo aperto e chiuso a 90° con basi h 17/23  
Wall units with metal 90° open and close corner elements

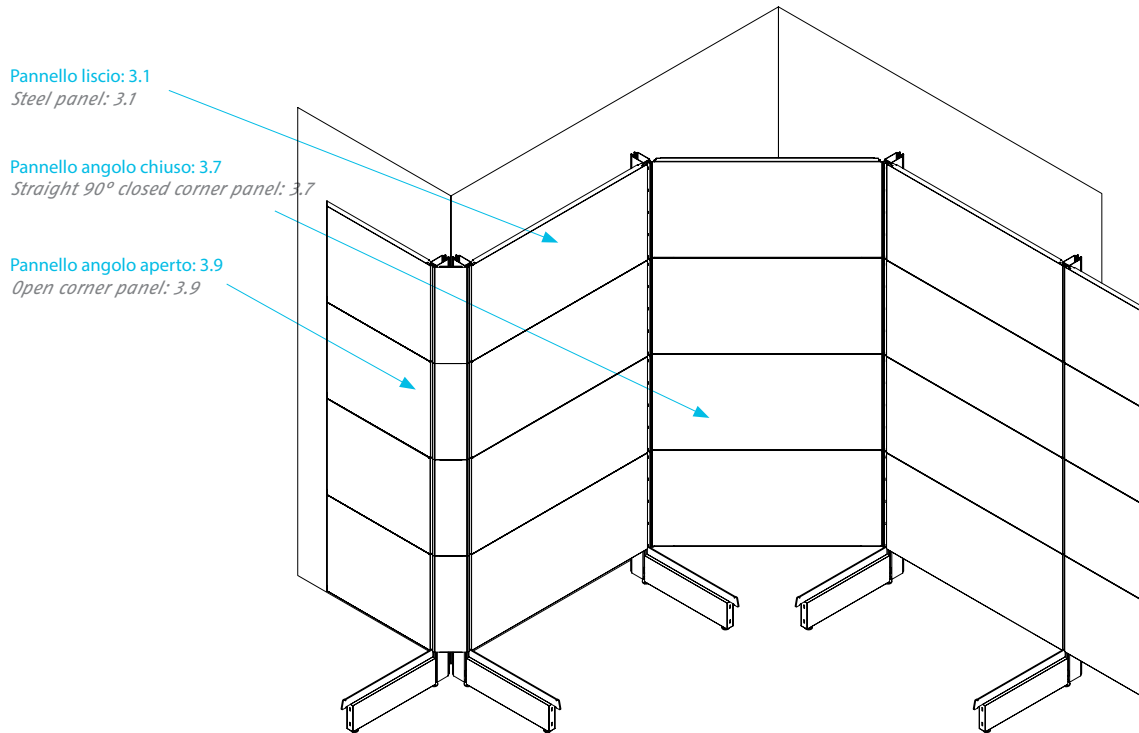

Pannello e zoccolo traverso base extra bassa/slim  
Cross and lower plinth

A Cava di partenza per l'aggancio dei pannelli di fondale  
Starting upright slot for back panels fixing

B Cava di partenza per l'aggancio del pannello di chiusura per basi h 12 Extrabassa/Slim  
Starting upright slot for 12 cm low base fixing

C Cava di partenza per l'aggancio del traverso semplice per pannelli legno.  
Starting upright slot for cross plinth fixing, for elements with wood backpanels

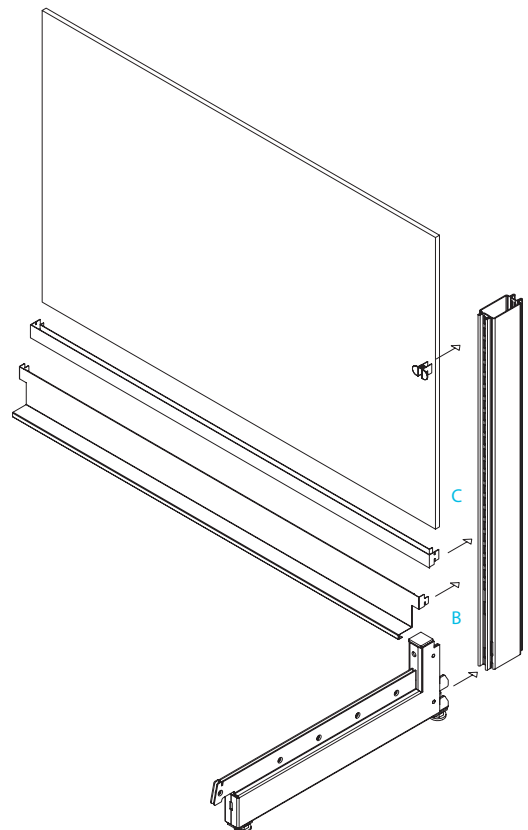
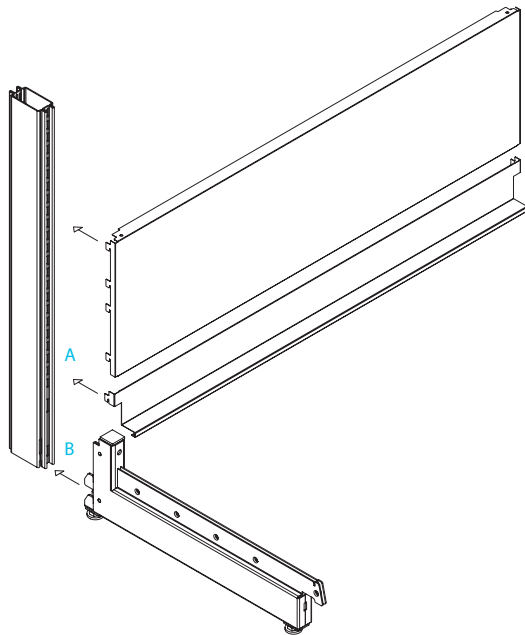

## Fondali lisci in metallo

### Steel panels

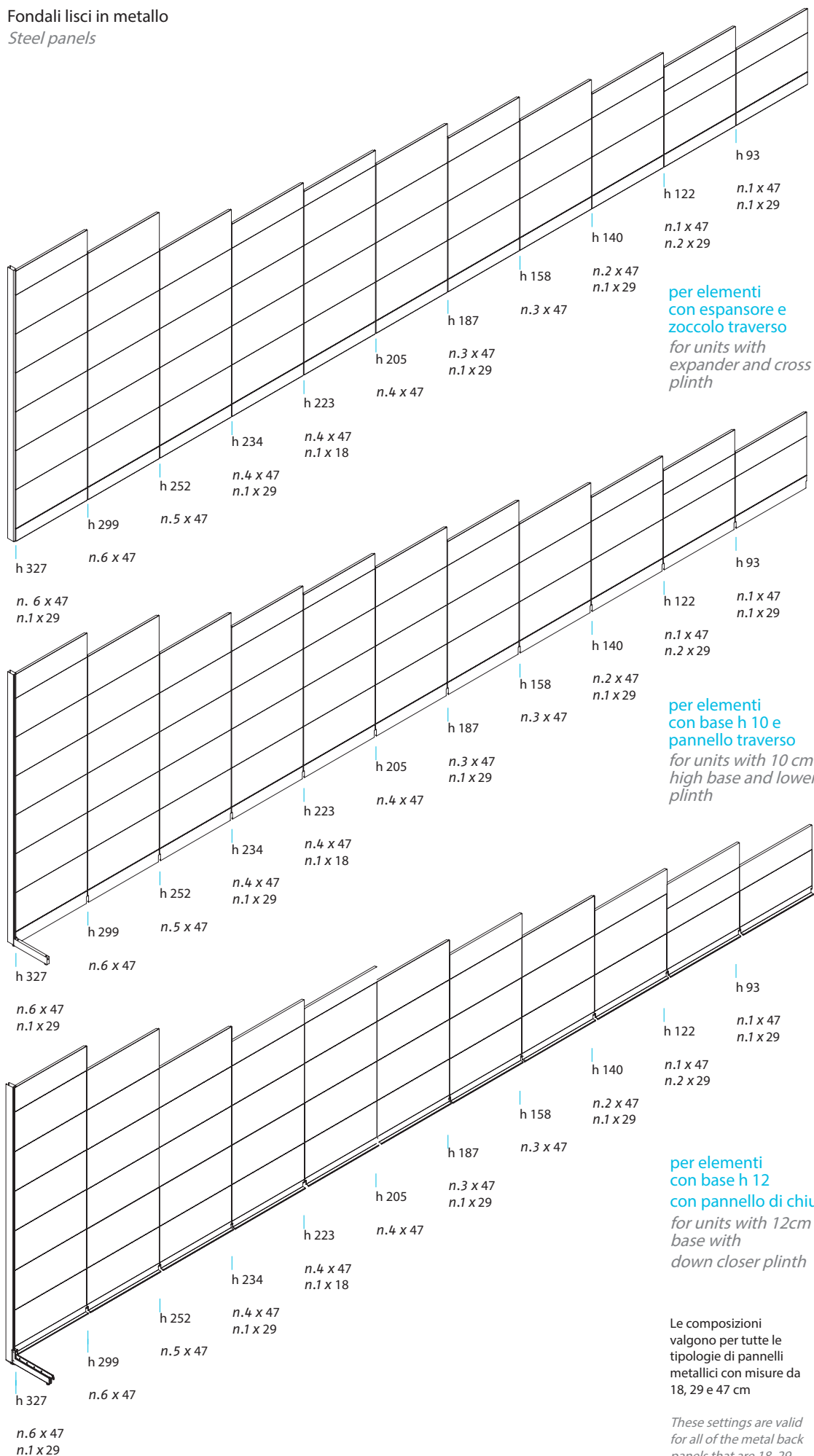

per elementi  
con espansore e  
zoccolo trasverso  
for units with  
expander and cross  
plinth

per elementi  
con base h 10 e  
pannello trasverso  
for units with 10 cm  
high base and lower  
plinth

per elementi  
con base h 12  
con pannello di chiusura  
for units with 12cm low  
base with  
down closer plinth

Le composizioni  
valgono per tutte le  
tipologie di pannelli  
metallici con misure da  
18, 29 e 47 cm

These settings are valid  
for all of the metal back  
panels that are 18, 29  
and 47 cm high

Fondali lisci in metallo  
Steel panels

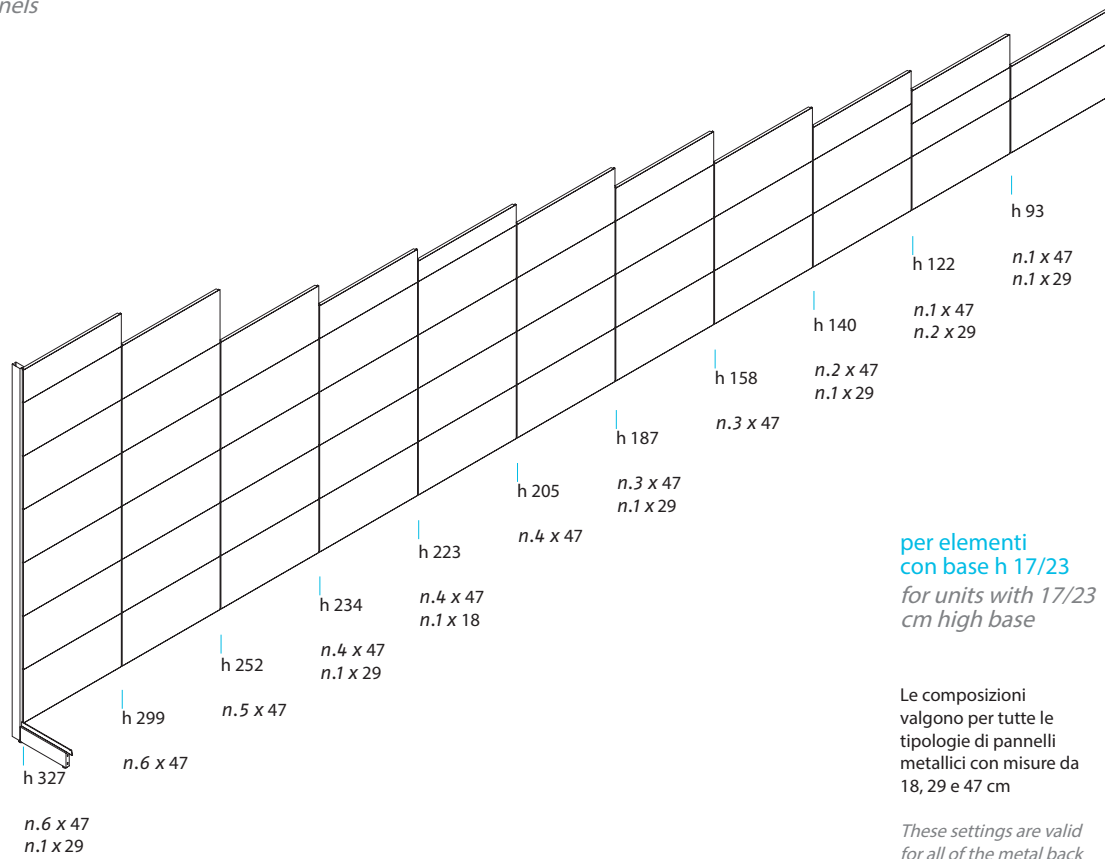



Fondali a doghe in metallo  
Slatted metal panels

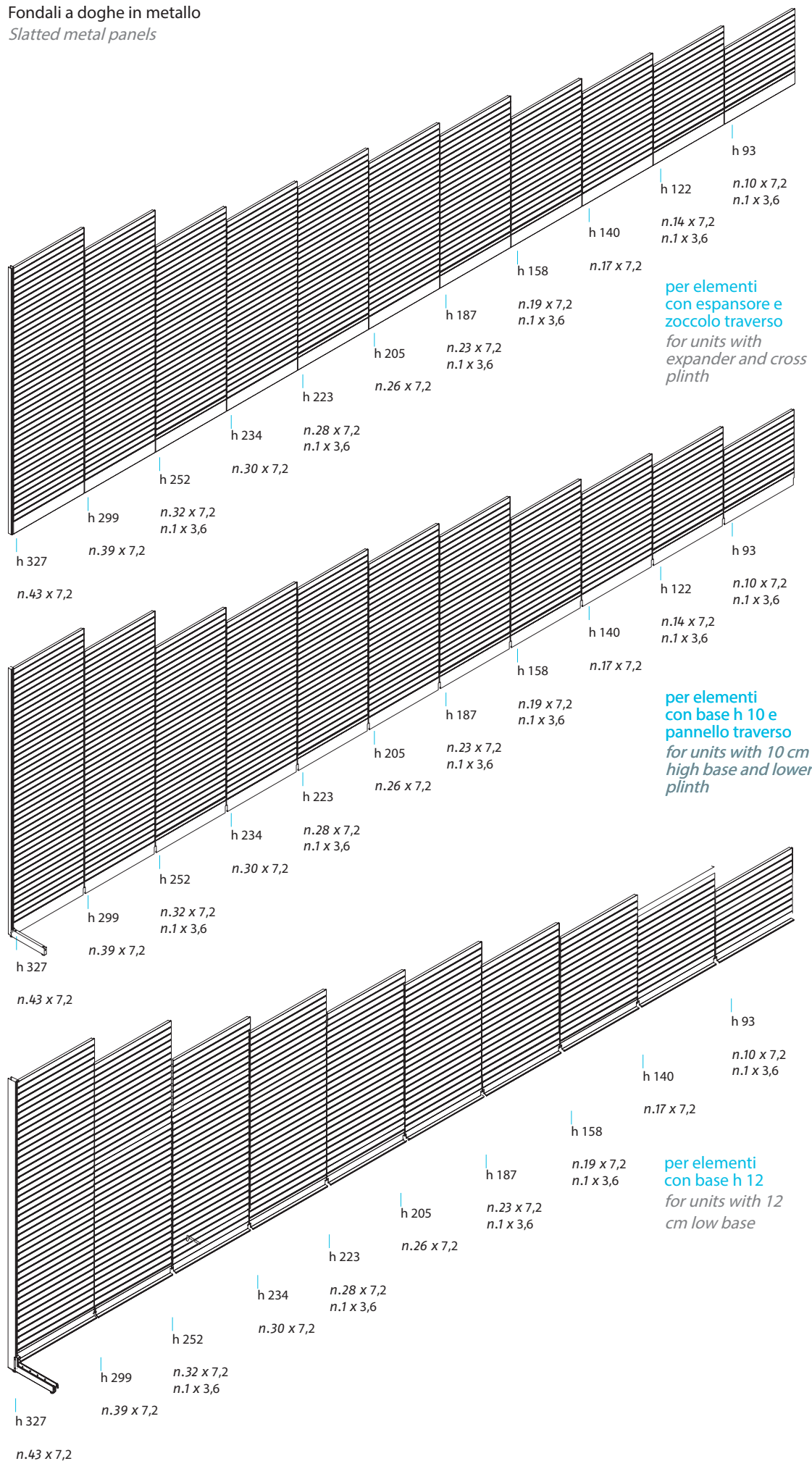

Fondali a doghe in metallo  
Slatted metal panels

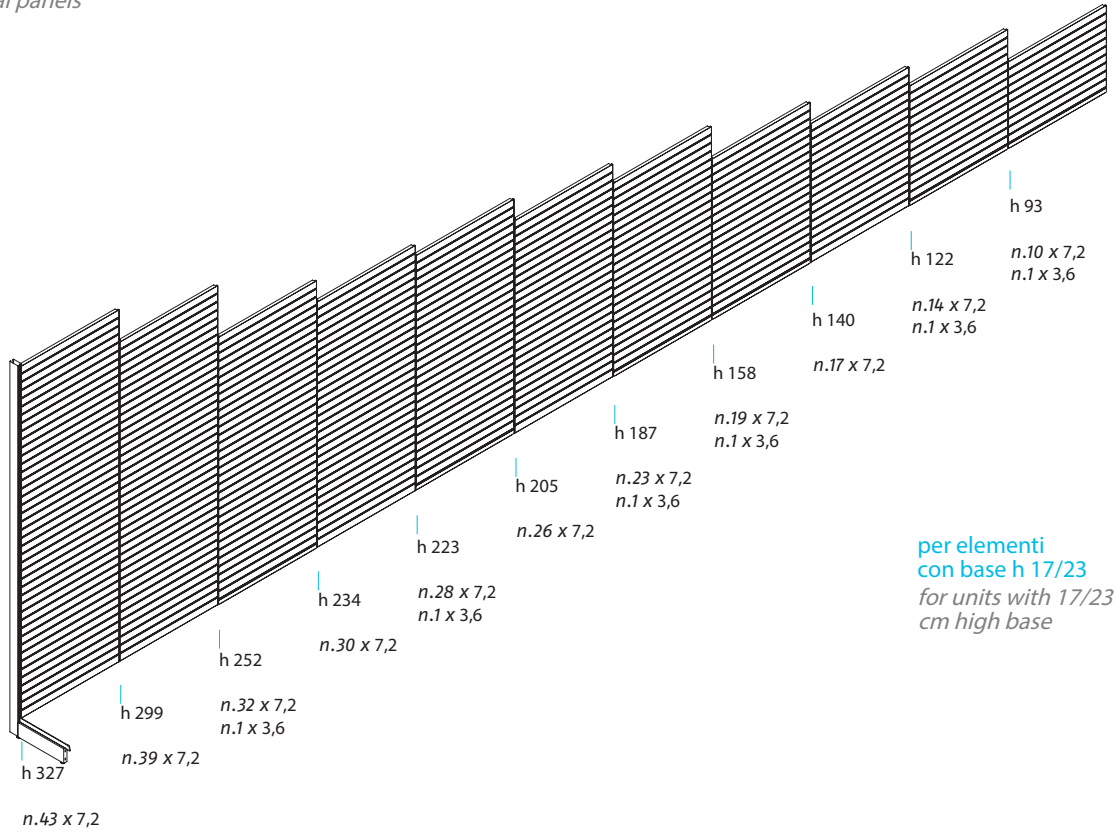

Pannelli in legno  
Wooden back panels

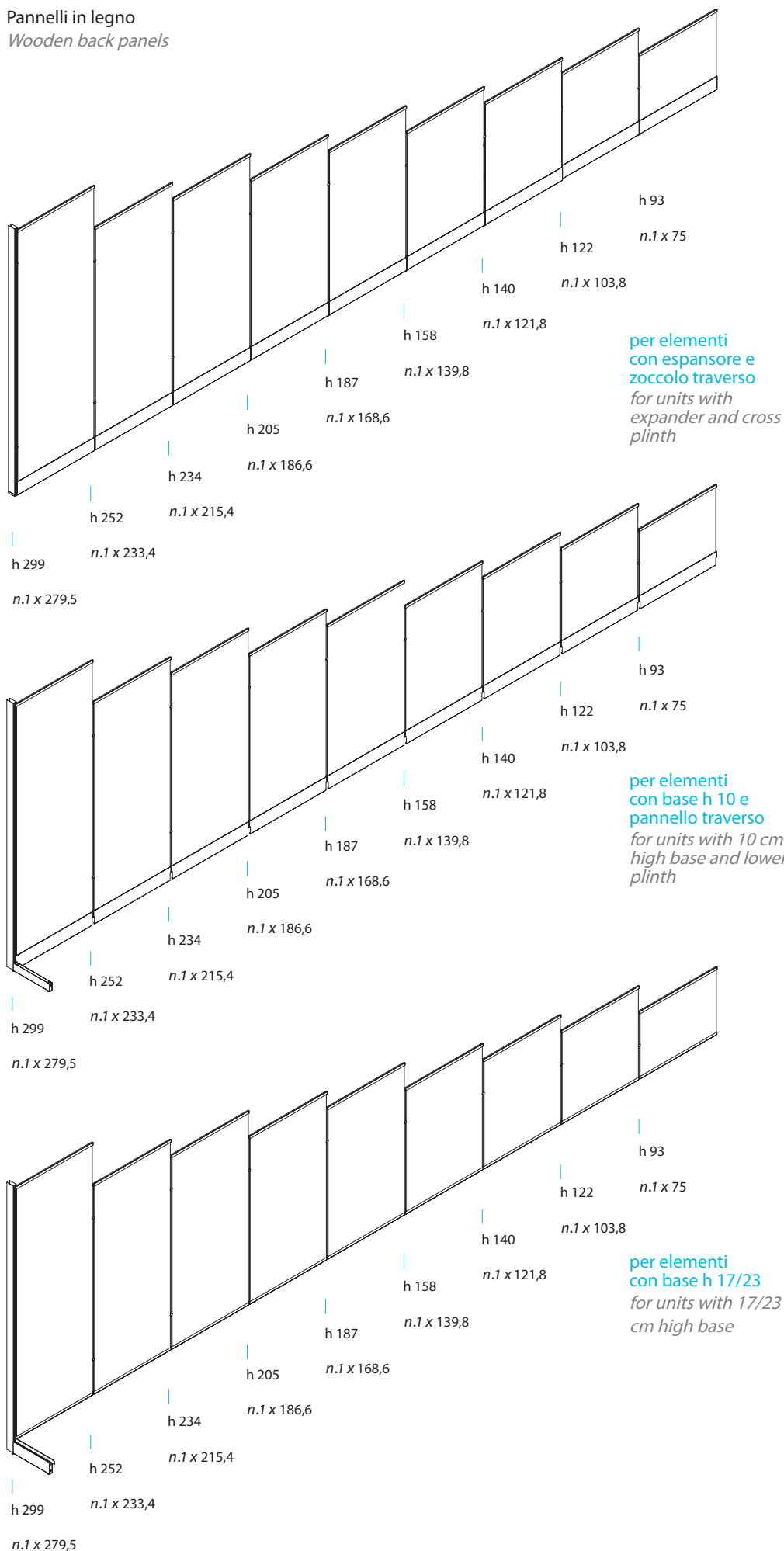

Pannelli in legno  
Wooden back panels

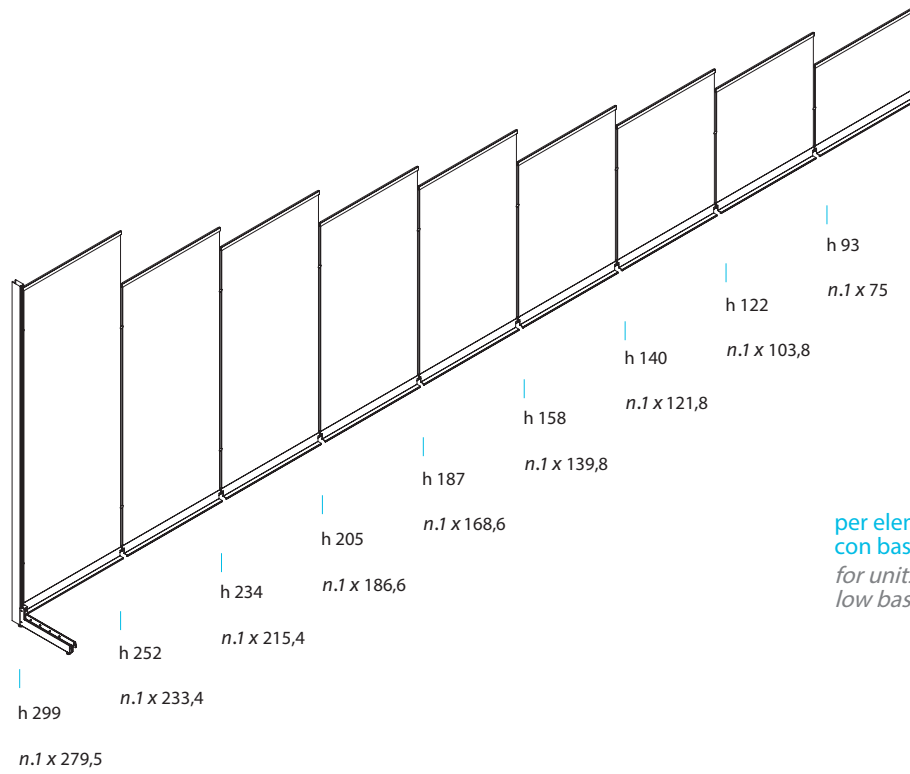

per elementi  
con base h 12  
for units with h 12 cm  
low base

Fondali legno dogati  
Slatted wooden panels

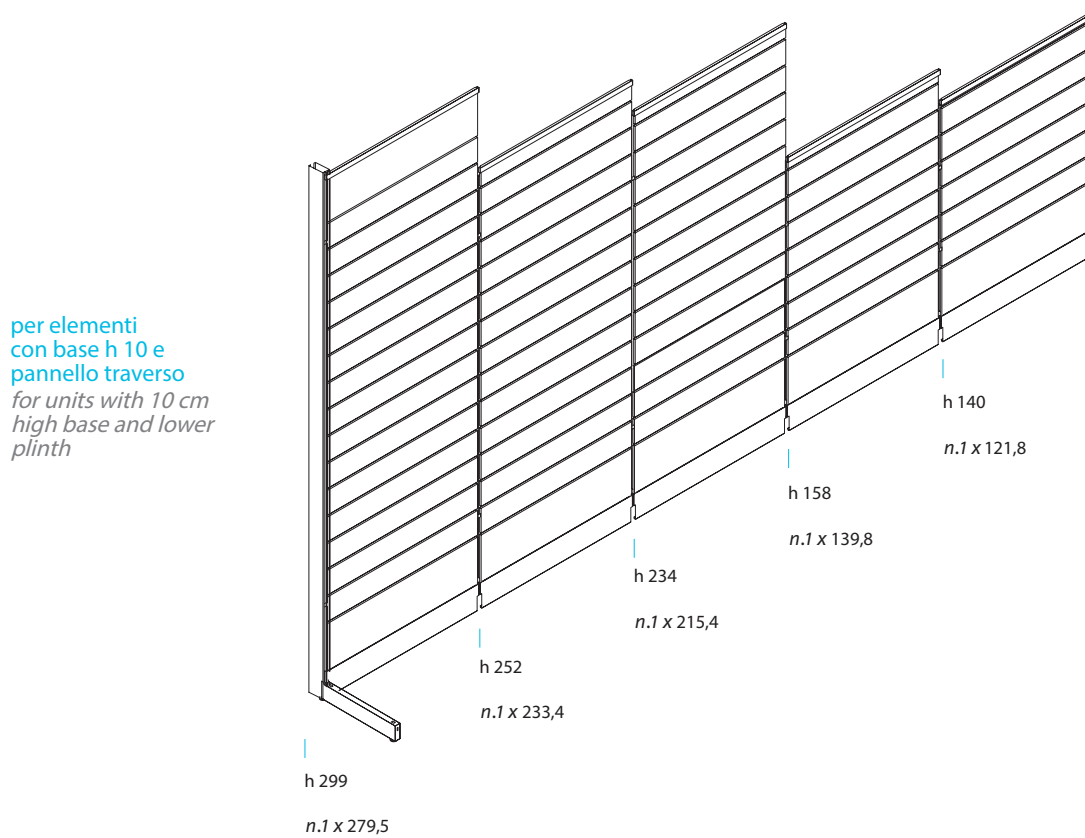
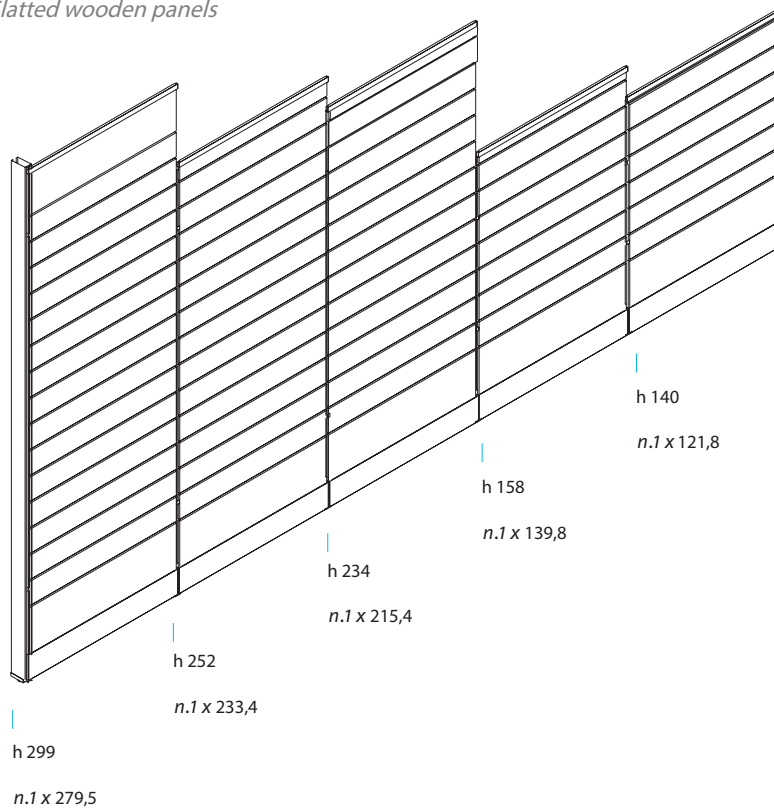

Fondali legno dogati  
Slatted wooden panels

per elementi  
con base h 12  
for units with 12 cm  
low base

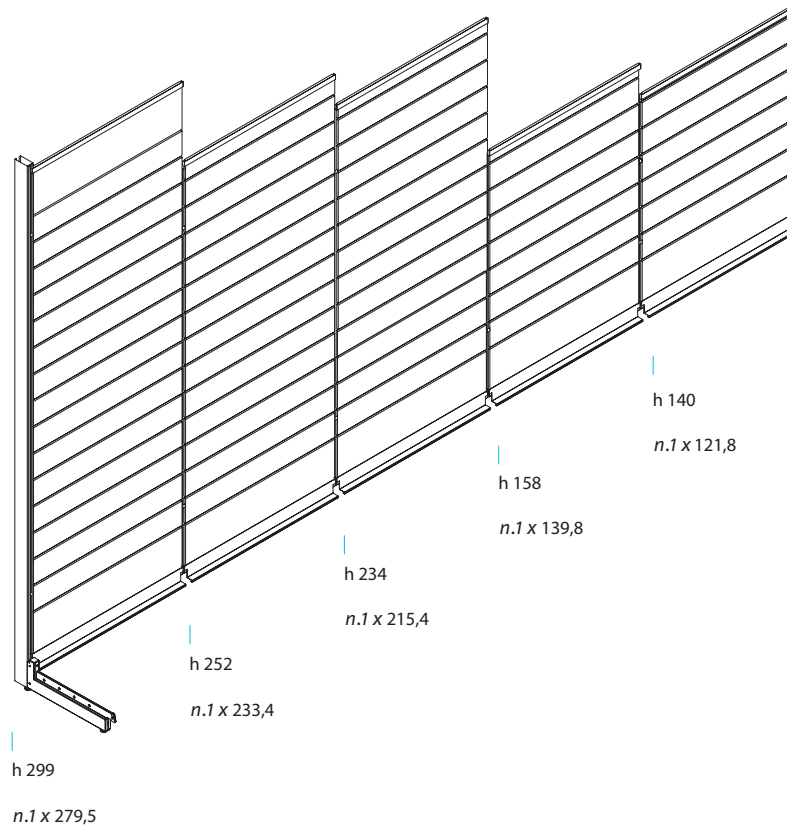

per elementi  
con base h 17/23  
for units with 17/23  
cm high base

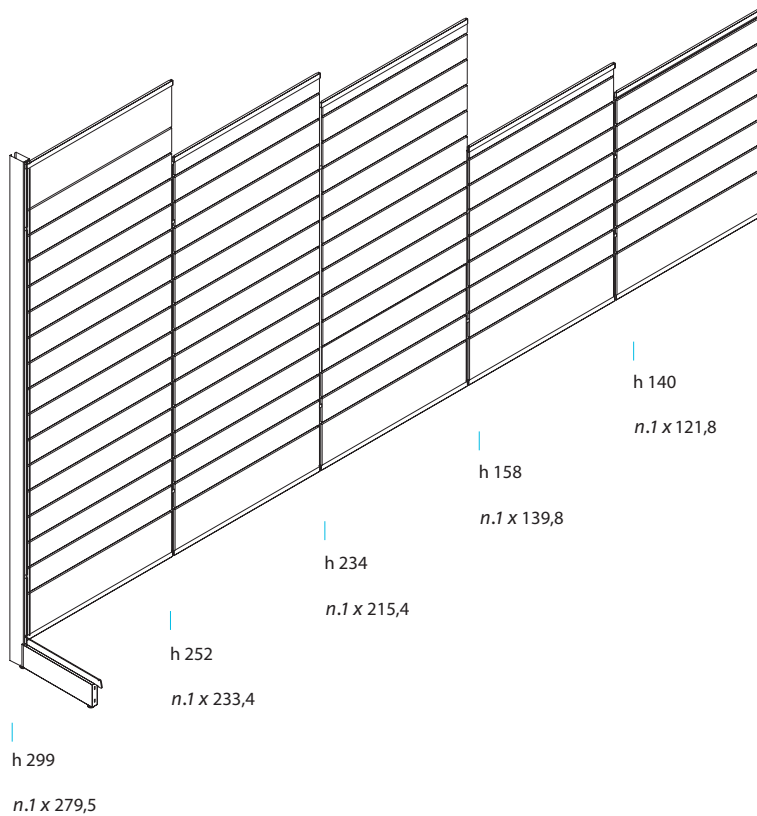

Fondali a doghe legno per televisori  
Wooden slatted panels for TV sets

per elementi a parete  
con espansore e zoccolo  
trasverso  
for wall units with expander  
and cross plinth

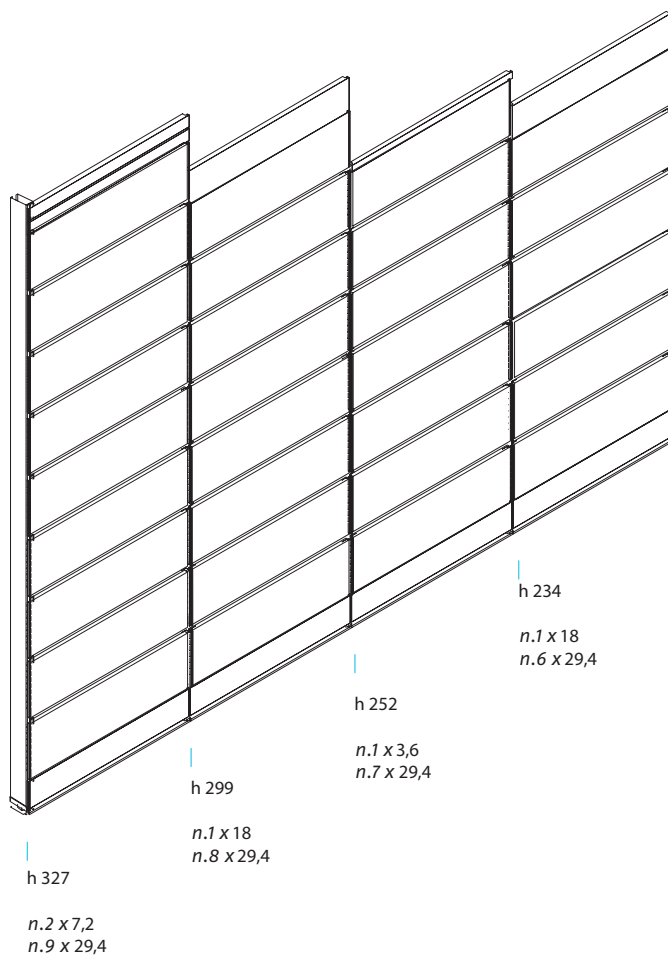

per elementi a parete  
con base h 10 e  
pannello trasverso  
for wall units with 10 cm low  
base and lower plinth

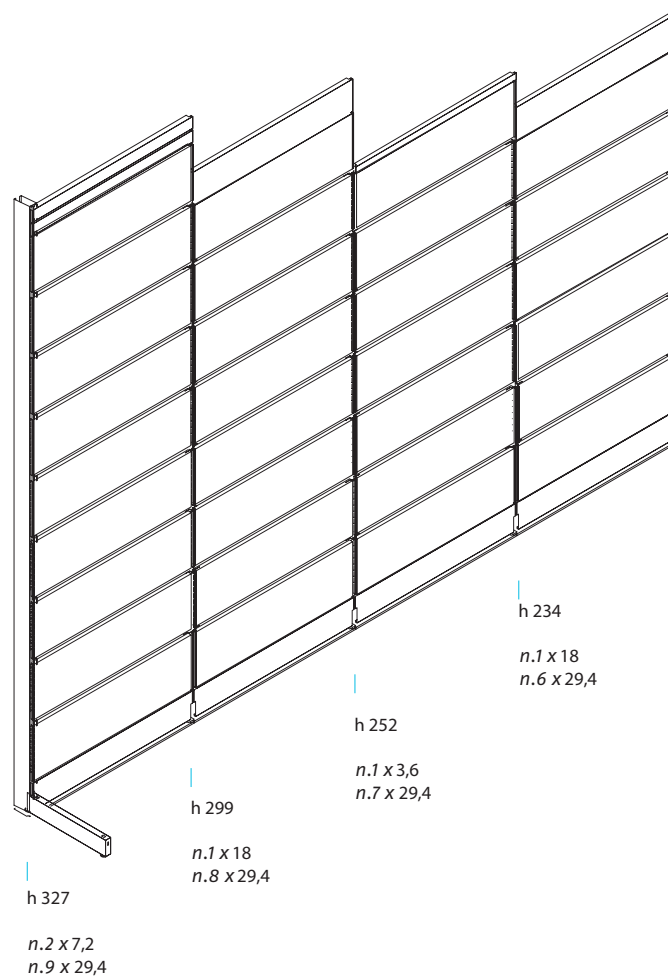

Fondali a doghe legno per televisori  
Wooden slatted panels for TV sets

per elementi a parete  
con base h 12 e  
pannello trasverso  
for wall units with 12 cm low  
base and lower plinth

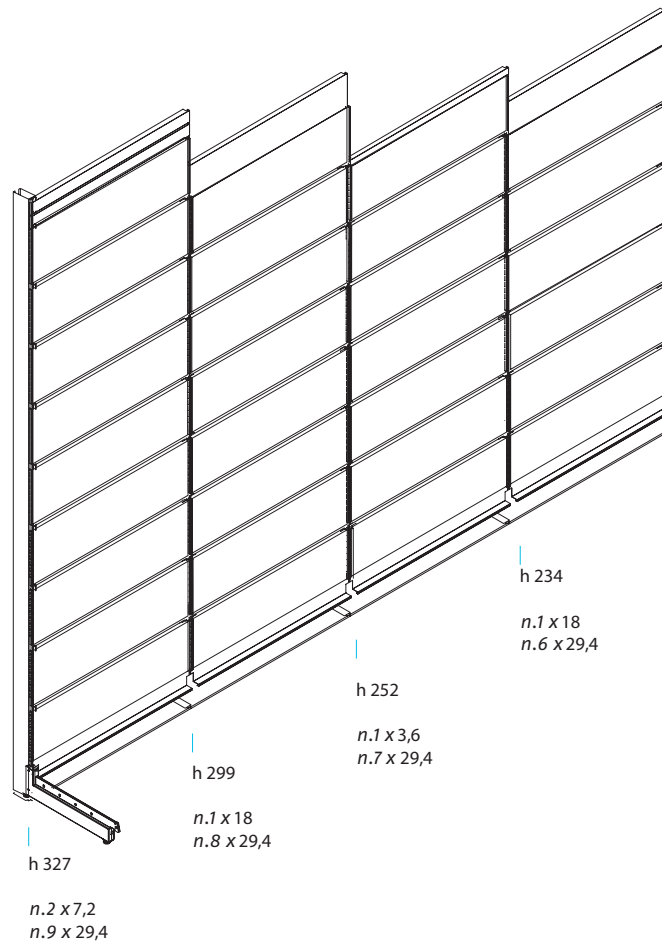



## Fondali a feritoie in acciaio

Steel slit panels

per elementi a parete  
con espansore e zoccolo  
trasverso  
for wall units with expander  
and cross plinth

Sportello fondale con supporti: 3.2  
Back panel door with support: 3.2

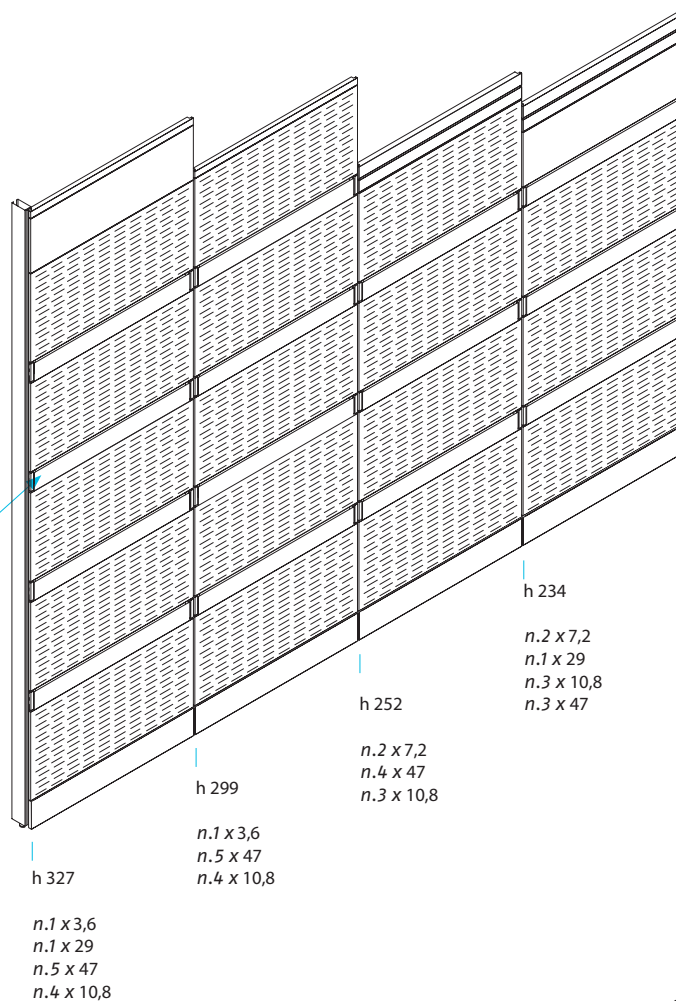

per elementi a parete  
con base h 10 e  
pannello trasverso  
for wall units with 10 cm high  
base and lower plinth

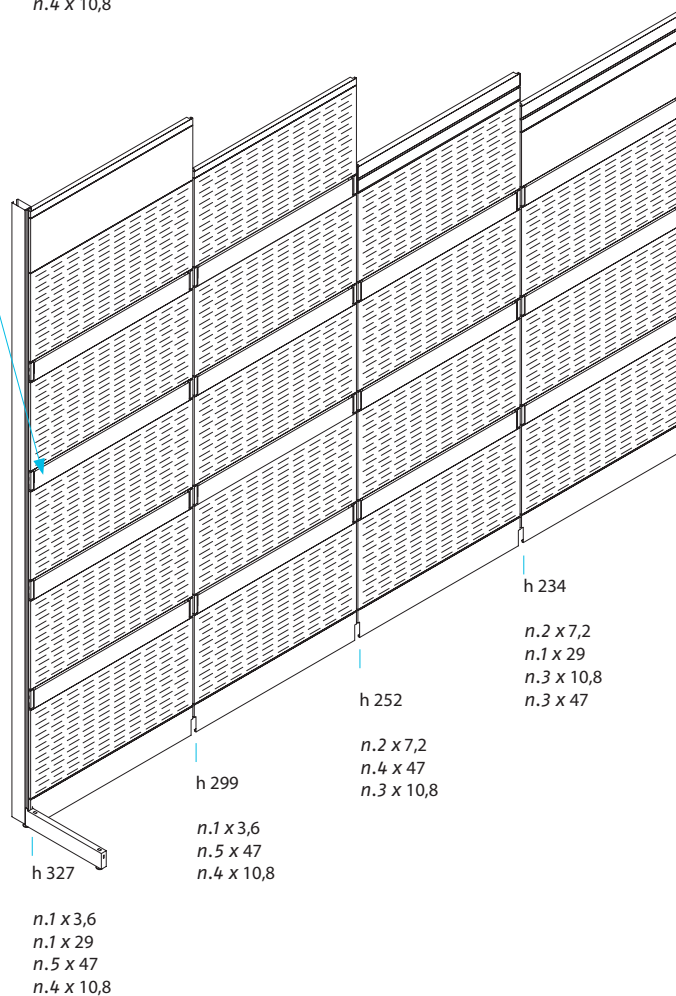

per elementi a parete  
con base h 12 e  
pannello trasverso  
for wall units with 10 cm high  
base and lower plinth

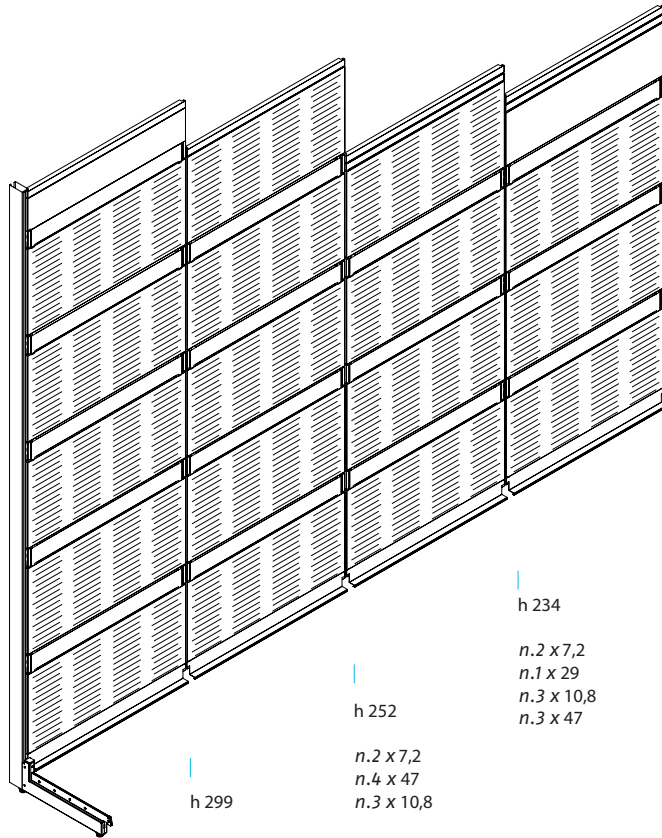

h 327

n.1 x 3,6  
n.1 x 29  
n.5 x 47  
n.4 x 10,8

h 299

n.1 x 3,6  
n.5 x 47  
n.4 x 10,8

h 252

n.2 x 7,2  
n.4 x 47  
n.3 x 10,8

h 234

n.2 x 7,2  
n.1 x 29  
n.3 x 10,8  
n.3 x 47

Fondali con pannelli a cornice in acciaio per televisori  
Steel framed panels for TV sets

per elementi a parete  
con espansore e zoccolo  
trasverso  
for wall units with expander  
and cross plinth

Sportello fondale con supporti: 3.2  
Back panel door with support: 3.2

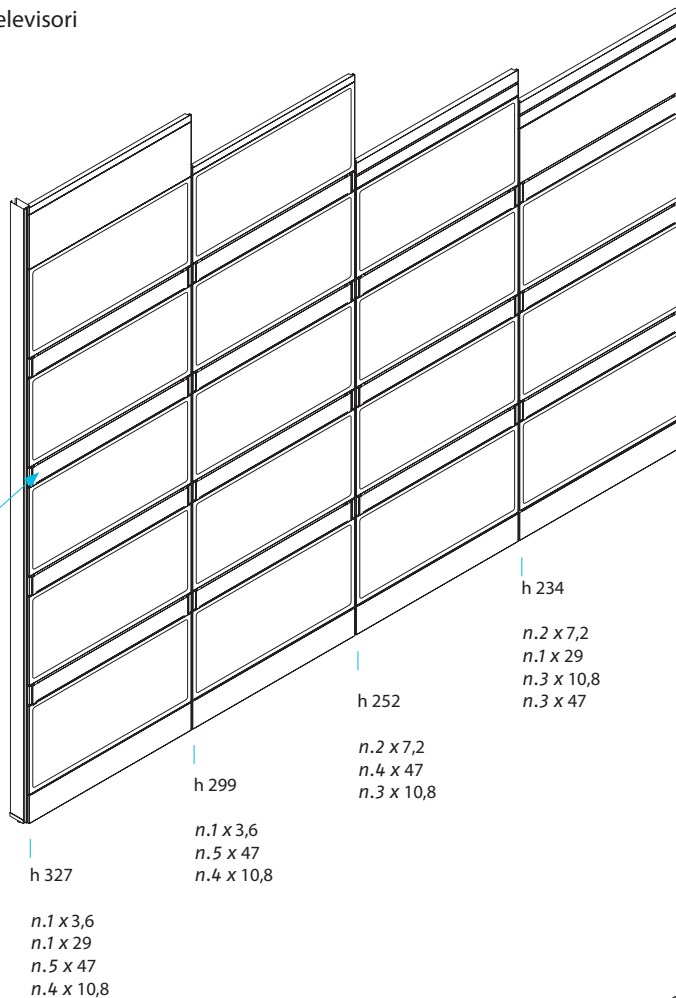

per elementi a parete  
con base h 10 e  
pannello trasverso  
for wall units with 10 cm high  
base and lower plinth

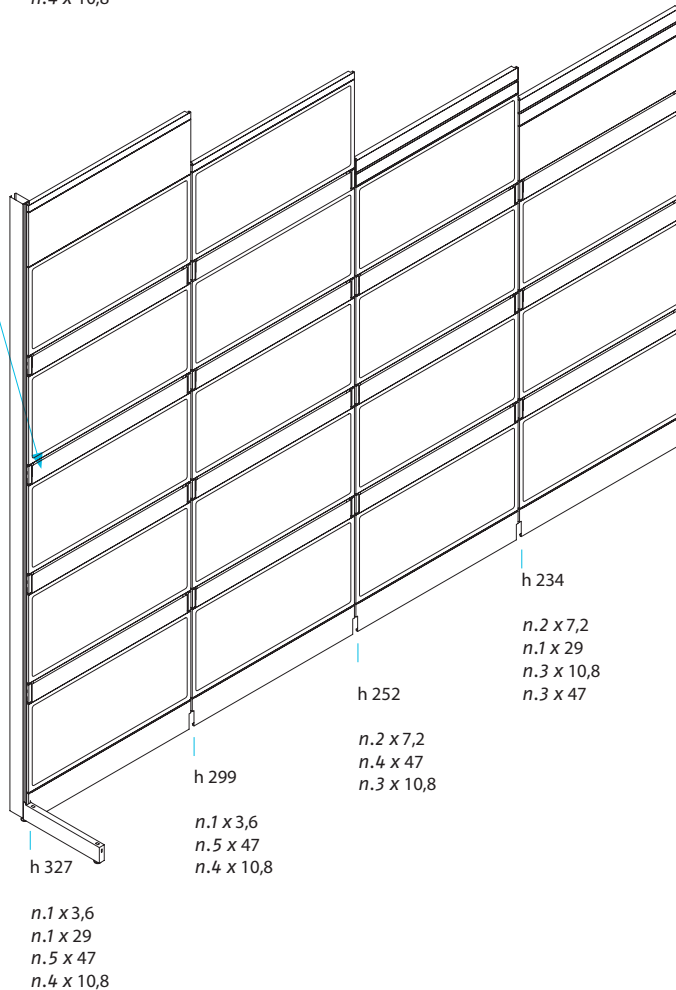

per elementi a parete  
con base h 12 e  
pannello trasverso  
for wall units with 12 cm high  
base and lower plinth

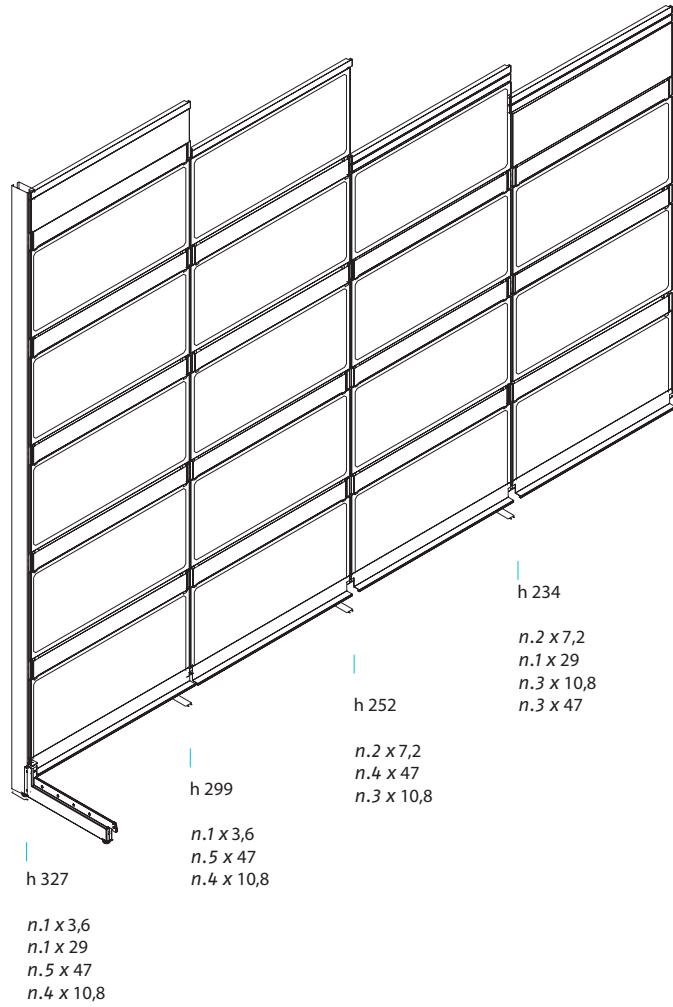

Composizione fondali con piantana angolare per rivestimento pilastri  
*Setting of back panels with angle upright for pillar facing*

Fondali a specchio con zoccolo traverso  
*Mirror panels with cross plinth*

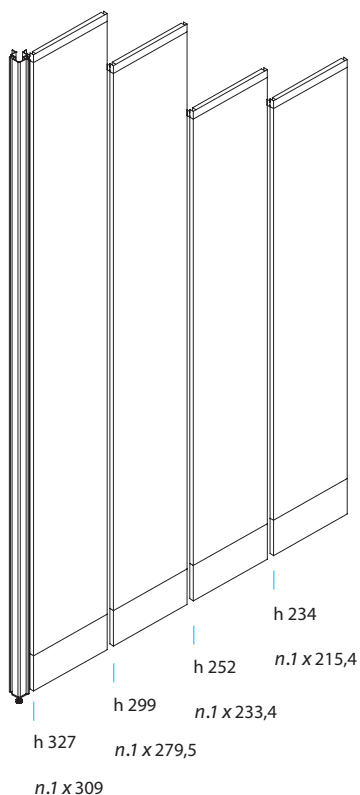

Fondali in legno con zoccolo traverso  
*Wooden panels with cross plinth*

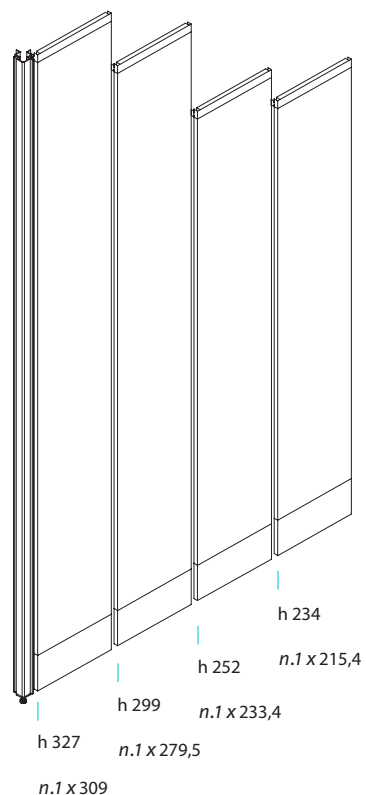

Fondali a doghe portanti  
*Load bearing slatted panels*

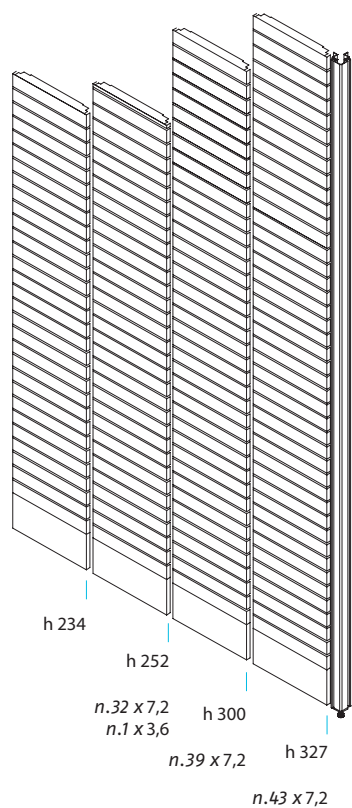

Le doghe da 7,2 e da 3,6 sono in metallo  
*7,2 and 3,6 cm high slats are load bearing metal slats.*

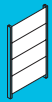

Fondali  
Back Panels

3.1

Pannelli lisci in acciaio  
Steel panels

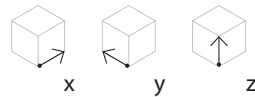
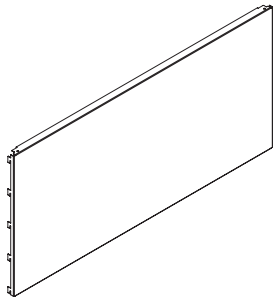
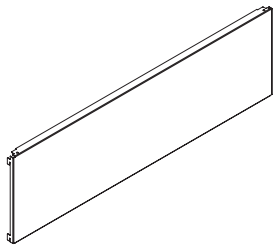
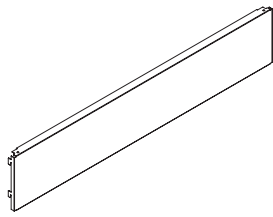

	x	y	z	codice code	note notes
	50	--	18	13.247	
	66,5	--	18	13.249	
	75	--	18	13.246	
	100	--	18	13.245	
	133	--	18	13.248	
	50	--	29	13.-07	
	66,5	--	29	13.149	
	75	--	29	13.-06	
	100	--	29	13.-05	
	133	--	29	13.-08	
	50	--	47	13.-03	
	66,5	--	47	13.148	
	75	--	47	13.-02	
	100	--	47	13.-01	
	133	--	47	13.-04	

finitura finish	colori colours
P	V
	2004
	6018
	6027
•	7035
	AMA
	• ANT
	AZZ
	1001
•	BIA
	BLU
	GIA
	MAR
•	• MTZ
	PAN
	RO3
	BIMCL
	NRMCL
	• OXI

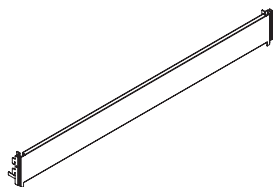

3.2

Sportello fondale con supporti  
Back panel door with support

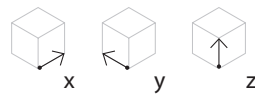

	x	y	z	codice code	note notes
	50	--	10,8	13.328	
	75	--	10,8	13.330	
	100	--	10,8	13.331	

finitura finish	colori colours
P	V
	2004
	6018
	6027
•	7035
	AMA
	• ANT
	AZZ
	1001
•	BIA
	BLU
	GIA
	MAR
	• MTZ
•	PAN
	RO3
	BIMCL
	NRMCL
	• OXI

Da utilizzare in caso di elettrificazione  
To be used in case

un pannello da 29 cm h corrisponde ad un pannello da 18 cm h più uno sportello fondale da 10,8 cm h  
A 29 cm high panel it's equal to an 18 cm high panel added to a 10,8 cm high back panel door

Fondali  
Back Panels

3.3

Pannelli forati in acciaio  
Perforated steel panels

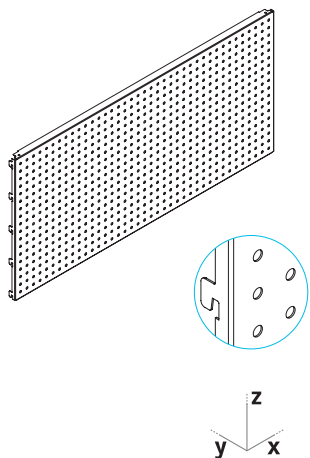

x	y	z	codice code	note notes
50	--	47	13.-78	
66,5	--	47	13.150	
75	--	47	13.-77	
100	--	47	13.-09	
133	--	47	13.-10	

finitura finish	colori colours
P	V
	2004
	6018
	6027
•	7035
	AMA
	• ANT
	AZZ
	1001
•	BIA
	BLU
	GIA
	MAR
	• MTZ
•	PAN
	RO3
	BIMCL
	NRMCL
	• OXI

Pannello a parete  
Wall Panels

3.3b

Pannelli forati per fissaggio a parete  
Perforated wall panel

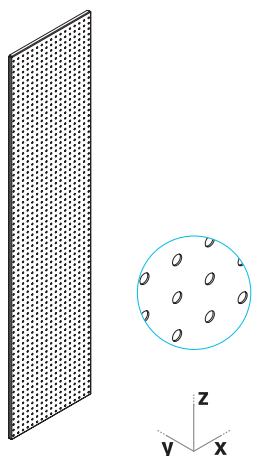

x	y	z	codice code	note notes
42,5	--	136,5	24.-03	
25	--	176,5	24.-01	
42,5	--	176,5	24.-02	

finitura finish	colori colours
P	V
	2004
	6018
	6027
•	7035
	AMA
	ANT
	AZZ
	1001
•	BIA
	BLU
	GIA
	MAR
•	MTZ
•	PAN
	RO3
	BIMCL
	NRMCL
	OXI

Fondali  
Back Panels

3.4

Pannelli asolati in acciaio  
Slotted steel panels

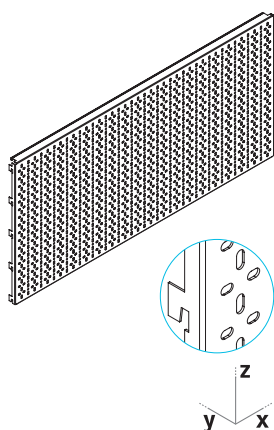

x	y	z	codice code	note notes
50	--	47	13.260	
66,5	--	47	13.386	
75	--	47	13.259	
100	--	47	13.258	
133	--	47	13.264	

finitura finish	colori colours	colori colours
	V	
	2004	MAR
	6018	• MTZ
	6027	• PAN
•	7035	RO3
	AMA	BIMCL
•	ANT	NRMCL
	AZZ	• OXI
	1001	
•	BIA	
	BLU	
	GIA	



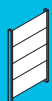

Fondali  
Back Panels

3.8

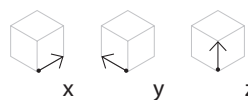
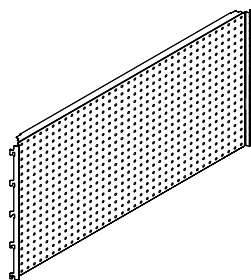
**Pannelli metallo forato angolo chiuso a 90°**  
*Straight 90° closed corner perforated panels*

x	y	z
--	--	47

codice code
13.539

note notes

finitura finish

colori colours

P	V
	2004
	6018
	6027
•	7035
	AMA
	• ANT
	AZZ
	1001
•	BIA
	BLU
	GIA
	MAR
	• MTZ
•	PAN
	RO3
	BIMCL
	NRMCL
	• OXI

Fondali  
Back Panels

3.9

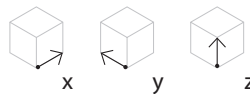
**Pannelli metallo angolo aperto**  
*Open corner steel panels*

x	y	z
--	--	18
--	--	29
--	--	47

codice code
13.266
13.-14
13.-13

note notes

finitura finish

colori colours

P	V
	2004
	6018
	6027
•	7035
	AMA
	• ANT
	AZZ
	1001
•	BIA
	BLU
	GIA
	MAR
	• MTZ
•	PAN
	RO3
	BIMCL
	NRMCL
	• OXI

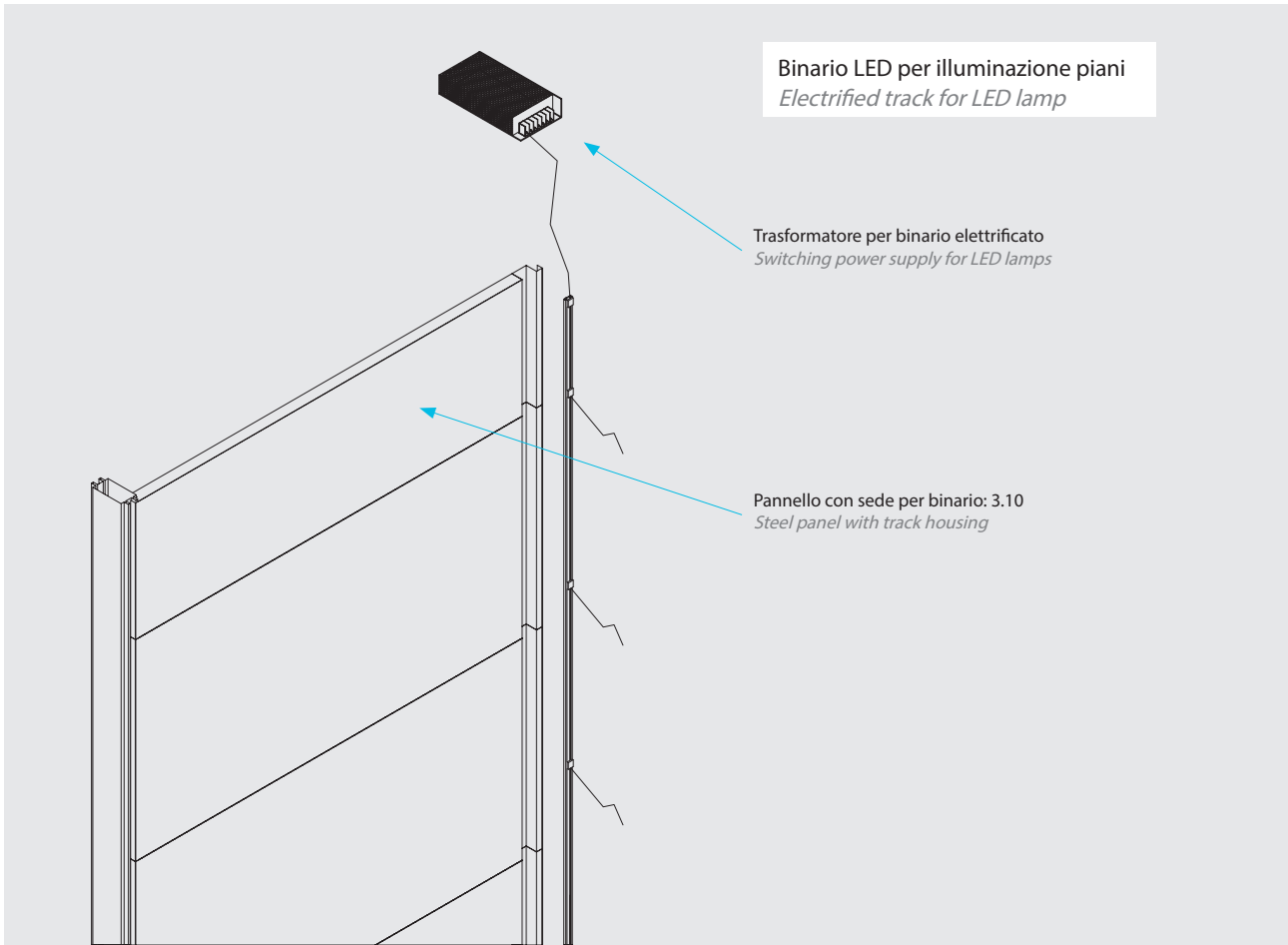

**Fondali**  
Back Panels

**3.10** Pannelli in metallo con sede dx per binario elettrificato  
Steel panels with electrified track housing

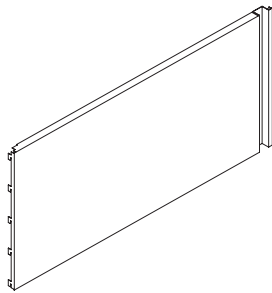

x	y	z	codice code	note notes	finitura finish	colori colours
66,5	--	18	13.372		P	
100	--	18	13.250			2004
133	--	18	13.251			6018
						6027
					•	7035
						AMA
						ANT
						AZZ
66,5	--	29	13.366			1001
100	--	29	13.240		•	BIA
133	--	29	13.241			BLU
						GIA
						MAR
					•	MTZ
					•	PAN
						RO3
66,5	--	47	13.367			BIMCL
100	--	47	13.238			NRMCL
133	--	47	13.239			OXI

Accessori per Fondali  
Back Panel Accessories

3.11

Binario elettrificato a bassissima tensione con magneti per luci a led  
*Extra- low voltage electrified track with magnets for led lamps*

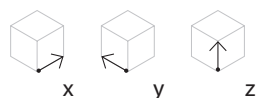
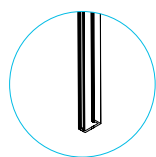

x	y	z	codice code	finitura e colore finish & colour	note notes
--	--	200	20.462	LED	
--	--	140	20.463	LED	

**Disponibile solo in  
finitura bianca**

*Available only in white  
colour*

Accessori per Fondali  
Back Panel Accessories

3.12

Trasformatore per binario elettrificato per luci a led  
*Switching power supply for led lamps*

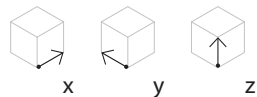
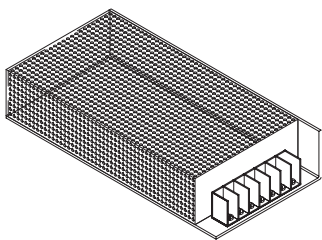

x	y	z	codice code	finitura e colore finish & colour	note notes
--	--	--	20.464	35 W - 12 V + connettore	
--	--	--	20.404	150 W - 12 V + connettore	
--	--	--	20.594	240 W - 12 V + connettore	

Cavo aggiuntivo a due poli con connettore per binario elettrificato  
*Additional two poles cable with connector for electrified track*

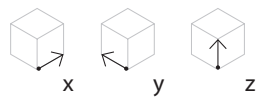

x	y	z	codice code	finitura e colore finish & colour	note notes
--	200	--	20.503		

**illuminazione LED: 4.24**  
*Led Lamps: 4.24*



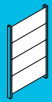

Fondali  
Back Panels

3.13

Pannello a cornice in acciaio  
Frame steel panel

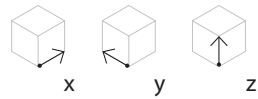
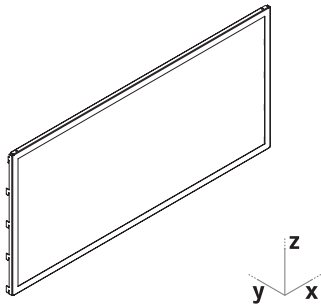

	x	y	z	codice code	note notes
50	--	47	13.376		
75	--	47	13.377		
100	--	47	13.378		

finitura finish	colori colours	colori colours
V	2004	MAR
	6018	• MTZ
	6027	• PAN
• 7035	AMA	RO3
• ANT	AZZ	BIMCL
	1001	NRMCL
	• BIA	• OXI
	BLU	
	GIA	

Pannello in nobilitato per pannello a cornice  
Wooden panel for frame steel panel

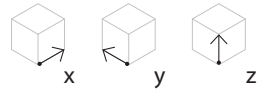
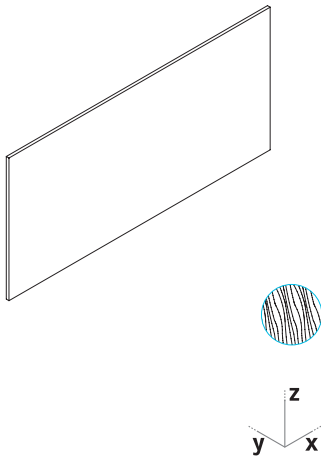

	x	y	z	codice code	note notes
47,7	1	45,9	13.-34		
72,7	1	45,9	13.-25		
97,7	1	45,9	13.-16		

finitura finish	colori colours	colori colours
T		
• 7035		A838
• ACE	7035	999XA
• BIA		995XM
• FAG		989XR
• MTZ		994XS
• PAN		997XS
• A439		983XR
• ANT		984XA
	K101	BLACK
	3813	GREEN
	2293	BEIGE
	990XA	WHITE
	990XM	

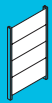

Fondali  
Back Panels

3.14

Pannello a cornice con telaio in rete  
Frame steel panel with wire mesh

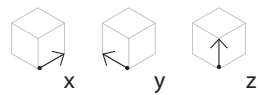
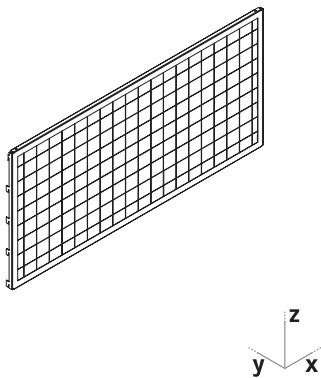

	x	y	z	codice code	note notes
66,5	--	47	13.542		
100	--	47	13.543		
133	--	47	13.544		

finitura finish	colori colours	colori colours
V	2004	
	6018	
	6027	
• 7035	AMA	
• ANT	AZZ	
	1001	
• BIA	BLU	
	GIA	
	MAR	
• MTZ	PAN	
• PAN	RO3	
	BIMCL	
	NRMCL	
• OXI		

Fondali  
Back Panels

3.15

Pannello traverso di chiusura per elementi con base h 10  
Lower plinth for wooden back panels on bay with 10 cm high base

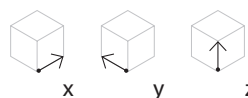
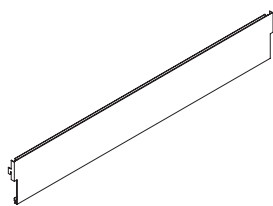

x	y	z	codice code	note notes
50	--	14,6	13.175	
75	--	14,6	13.173	
100	--	14,6	13.172	

finitura finish	colori colours
P	V
	2004
	6018
	6027
•	7035
	AMA
	• ANT
	AZZ
	1001
•	BIA
	BLU
	GIA
	MAR
	• MTZ
•	PAN
	RO3
	BIMCL
	NRMCL
	• OXI

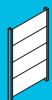
Fondali  
Back Panels

3.15b

Pannello traverso di chiusura per elementi con base h 12  
Lower plinth for back panels on bay with 12 cm low base

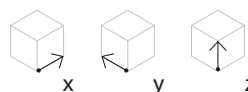
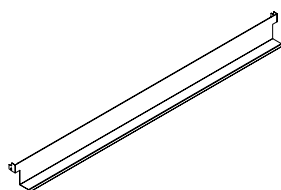

x	y	z	codice code	note notes
66,5	--	10	14.132	
100	--	10	14.130	
133	--	10	14.131	

finitura finish	colori colours
P	V
	2004
	6018
	6027
•	7035
	AMA
	• ANT
	AZZ
	1001
•	BIA
	BLU
	GIA
	MAR
	• MTZ
•	PAN
	RO3
	BIMCL
	NRMCL
	• OXI

Fondali  
Back Panels

3.16

Zoccolo traverso di chiusura per elementi con espansore  
Cross plinth for modules with steel expander

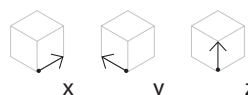
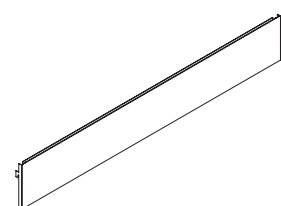

x	y	z	codice code	finitura finish	colori colours	colori colours
50	--	14,6	15.127	P	V	
66,5	--	14,6	15.125			• MTZ
75	--	14,6	15.126			PAN
100	--	14,6	15.101	•		RO3
133	--	14,6	15.102		•	BIMCL

finitura finish	colori colours	colori colours
	2004	
	6018	•
	6027	
•	7035	
	AMA	
	• ANT	
	AZZ	
	1001	
•	BIA	
	BLU	
	GIA	
	MAR	

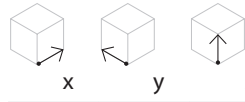
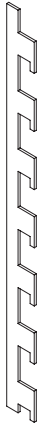

x	y	z	codice code	finitura e colore finish & colour	note notes
--	--	50	34.307	C	

Tabella comparativa fra pannelli e doghe  
Comparing panels and slats

	$n.1 \times 18 \text{ h}$		$n.2 \times 7,2 \text{ h}$ $n.1 \times 3,6 \text{ h}$
	$n.1 \times 29 \text{ h}$		$n.4 \times 7,2 \text{ h}$
	$n.1 \times 47 \text{ h}$		$n.6 \times 7,2 \text{ h}$ $n.1 \times 3,6 \text{ h}$
	$n.2 \times 47 \text{ h}$		$n.13 \times 7,2 \text{ h}$



Fondali  
Back Panels

3.18

Doghe portanti in metallo h 7,2  
Load bearing slats h 7,2

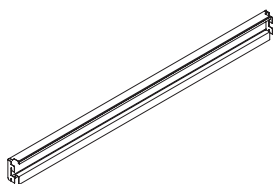

				codice code	note notes
	x	y	z		
	50	--	7,2	13.166	
	66,5	--	7,2	13.167	
	75	--	7,2	13.165	
	100	--	7,2	13.164	
	133	--	7,2	13.168	

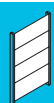

Fondali  
Back Panels

3.19

Doghe portanti in metallo h 3,6  
Load bearing slats h 3,6

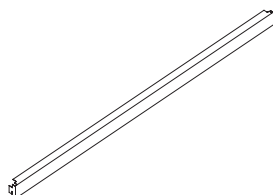

				codice code	note notes
	x	y	z		
	50	--	3,6	13.181	
	66,5	--	3,6	13.182	
	75	--	3,6	13.180	
	100	--	3,6	13.179	
	133	--	3,6	13.183	

finitura finish		colori colours
P	V	
		2004
		6018
		6027
•		7035
		AMA
	•	ANT
		AZZ
		1001
•		BIA
		BLU
		GIA
		MAR
	•	MTZ
•		PAN
		RO3
		BIMCL
		NRMCL
	•	OXI



Fondali  
Back Panels

3.20

Pannelli in legno per elementi con pannello o zoccolo traverso  
Wooden back panel for lower or cross plinth

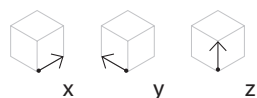
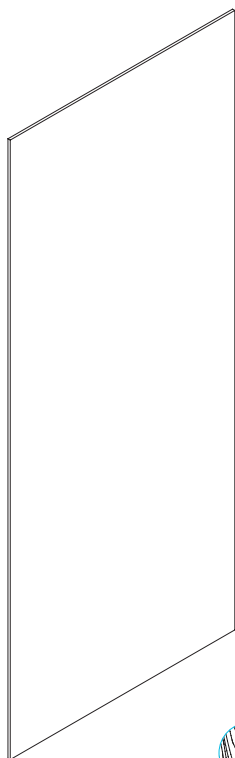

x	y	z	codice code	note notes
47,7	--	75	13.-36	
47,7	--	103,8	13.-38	
47,7	--	121,8	13.-39	
47,7	--	139,8	13.-40	
47,7	--	168,6	13.235	
47,7	--	186,6	13.-98	
47,7	--	215,4	13.-41	
47,7	--	233,4	13.214	
47,7	--	279,5	13.215	
72,7	--	75	13.-27	
72,7	--	103,8	13.-29	
72,7	--	121,8	13.-30	
72,7	--	139,8	13.-31	
72,7	--	168,6	13.234	
72,7	--	186,6	13.101	
72,7	--	215,4	13.-32	
72,7	--	233,4	13.211	
72,7	--	279,5	13.212	
97,7	--	75	13.-18	
97,7	--	103,8	13.-20	
97,7	--	121,8	13.-21	
97,7	--	139,8	13.-22	
97,7	--	168,6	13.233	
97,7	--	186,6	13.-97	
97,7	--	215,4	13.-23	
97,7	--	233,4	13.208	
97,7	--	279,5	13.209	
122,7	--	75	13.546	
122,7	--	103,8	13.547	
122,7	--	121,8	13.548	
122,7	--	139,8	13.549	
122,7	--	168,6	13.550	
122,7	--	186,6	13.551	
122,7	--	215,4	13.552	
122,7	--	233,4	13.553	
122,7	--	279,5	13.554	

finitura finish	colori colours
T	
•	7035
•	ACE
•	BIA
•	FAG
•	MTZ
•	PAN
•	A439
•	ANT
	K101
	3813
	2293
	990XA
	990XM
	A838
	999XA
	995XM
	989XR
	994XS
	997XS
	983XR
	984XA
	BLACK
	GREEN
	BEIGE
	WHITE



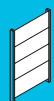

Fondali  
Back Panels

3.21

Fondali legno dogati per elementi con pannello o zoccolo traverso  
Slatted wooden panels for lower or cross plinth

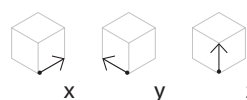
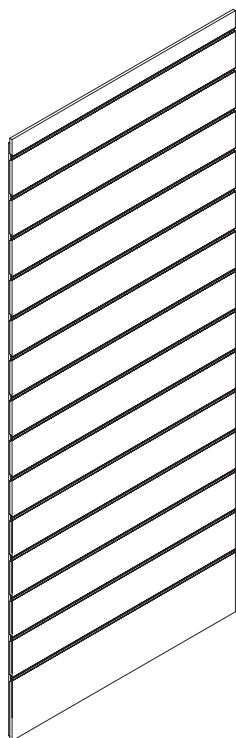

x	y	z	codice code	note notes
47,7	--	121,8	13.384	
47,7	--	139,8	13.364	
47,7	--	215,4	13.306	
47,7	--	233,4	13.379	
47,7	--	279,5	13.580	
72,7	--	121,8	13.380	
72,7	--	139,8	13.358	
72,7	--	215,4	13.305	
72,7	--	233,4	13.381	
72,7	--	279,5	13.581	
97,7	--	121,8	13.382	
97,7	--	139,8	13.356	
97,7	--	215,4	13.304	
97,7	--	233,4	13.383	
97,7	--	279,5	13.582	
122,7	--	121,8	13.555	
122,7	--	139,8	13.556	
122,7	--	215,4	13.559	
122,7	--	233,4	13.560	
122,7	--	279,5	13.561	

finitura finish	colori colours
T	
•	7035
•	ACE
•	BIA
	FAG
•	MTZ
•	PAN
•	A439
•	ANT
	K101
	3813
	2293
	990XA
	990XM
	A838
	999XA
	995XM
	989XR
	994XS
	997XS
	983XR
	984XA
	BLACK
	GREEN
	BEIGE
	WHITE



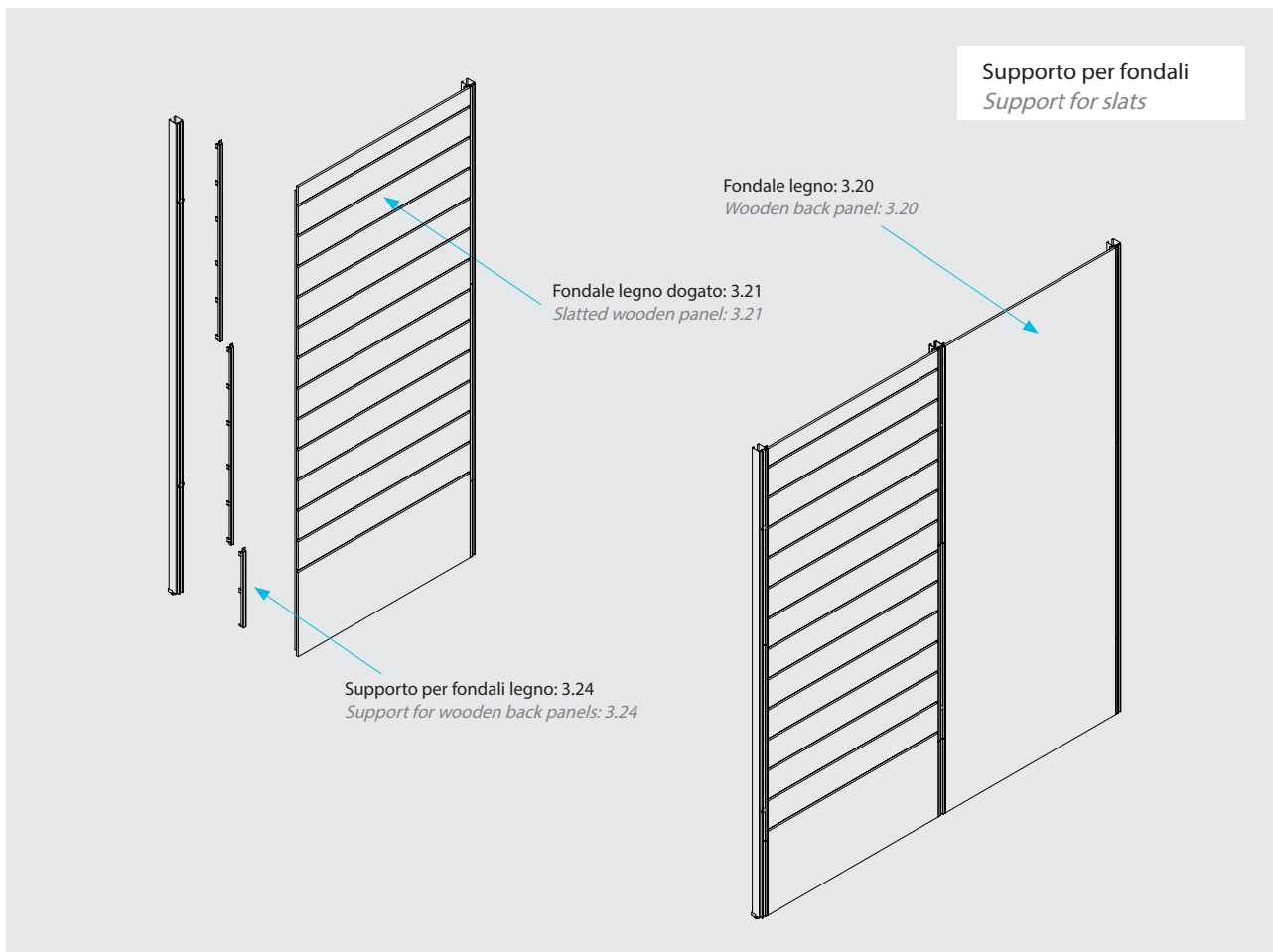

Accessori per Fondali  
Back Panel Accessories

3.24

Supporto per fondali legno h 100  
H 100 cm support for wooden back panels

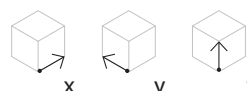

dx/sx	x	y	z	codice code	note notes
--	--	--	100	34.724	

finitura finish	colori colours
V	2004
	6018
	6027
•	7035
	AMA
•	ANT
	AZZ
	1001
•	BIA
	BLU
	GIA
	MAR
•	MTZ
•	PAN
	RO3
	BIMCL
	NRMCL
•	OXI

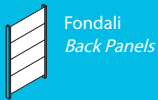



Fondali  
Back Panels

3.25

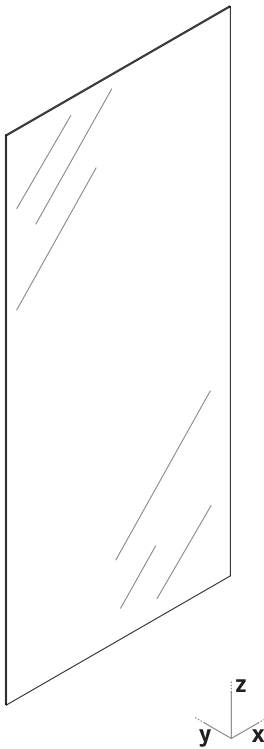

Fondali a specchio per elementi con pannello o zoccolo traverso  
*Mirror back panel for lower or cross plinth*

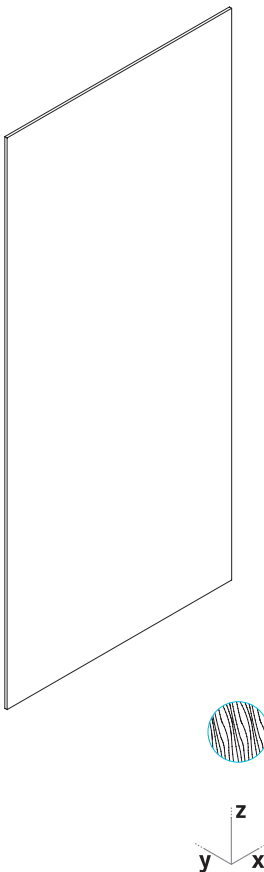

 x	 y	 z	codice code	finitura e colore finish & colour	note notes
47,7	--	215,4	13.222	NP	
47,7	--	233,4	13.312	NP	
47,7	--	279,5	13.313	NP	
72,7	--	215,4	13.-87	NP	
72,7	--	233,4	13.309	NP	
72,7	--	279,5	13.310	NP	
97,7	--	215,4	13.-45	NP	
97,7	--	233,4	13.242	NP	
97,7	--	279,5	13.307	NP	

Fondali in legno truciolare grezzo a supporto dello specchio  
*Wooden back panel for mirror back panel*



 x	 y	 z	codice code	finitura e colore finish & colour	note notes
47,7	--	215,4	13.-41	G	
47,7	--	233,4	13.320	G	
47,7	--	279,5	13.321	G	
72,7	--	215,4	13.-32	G	
72,7	--	233,4	13.317	G	
72,7	--	279,5	13.318	G	
97,7	--	215,4	13.-23	G	
97,7	--	233,4	13.244	G	
97,7	--	279,5	13.315	G	

Accessori per Fondali  
Back Panel Accessories

3.26

Traversino semplice per fondali in legno  
Plain crosspiece for wooden back panels

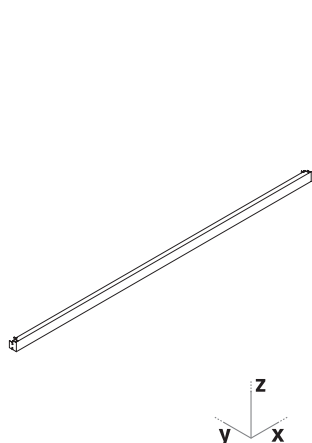

x	y	z	codice code	note notes
50	1	2,8	14.-06	
75	1	2,8	14.-05	
100	1	2,8	14.-04	
125	1	2,8	14.-16	

finitura finish		colori colours	
P	V		
			2004
			6018
			6027
		•	7035
			AMA
		•	ANT
			AZZ
			1001
		•	BIA
			BLU
			GIA
			MAR
		•	MTZ
		•	PAN
			RO3
			BIMCL
			NRMCL
		•	OXI

Accessori per Fondali  
Back Panel Accessories

3.27

Giunzione ad H in alluminio per fondali in legno  
Aluminium H junction for tailored wooden back panels



x	y	z	codice code	note notes
50	--	1,2	18.-03	
75	--	1,2	18.-02	
100	--	1,2	18.-01	
125	--	1,2	18.371	

finitura finish		colori colours	
N	V		
			2004
			6018
			6027
		•	7035
			AMA
		•	ANT
			AZZ
			1001
		•	BIA
			BLU
			GIA
			MAR
		•	MTZ
		•	PAN
			RO3
			BIMCL
			NRMCL
		•	OXI
		•	---

Accessori per Fondali  
Back Panel Accessories

3.28

Gancio ferma fondali in legno  
Stop clip for tailored wooden back panels

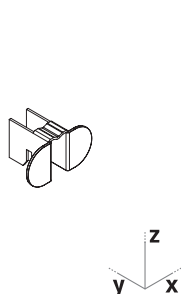

x	y	z	codice code	finitura e colore finish & colour	note notes
3,7	2,4	--	34.-01	C	

Accessori per Fondali  
Back Panel Accessories

3.29

Coperchio speciale doppi fondali metallo  
Special top closer for double back panels

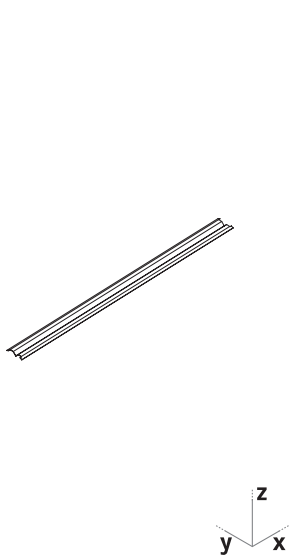

	x	y	z	codice code	note notes
piantana upright y=7,2	50	7,5	--	14.-54	
	66,5	7,5	--	14.-73	
	75	7,5	--	14.-53	
	100	7,5	--	14.-52	
	133	7,5	--	14.-72	
piantana upright y=9	50	9,3	--	14.-76	
	66,5	9,3	--	14.-78	
	75	9,3	--	14.-75	
	100	9,3	--	14.-74	
	133	9,3	--	14.-77	

finitura finish	colori colours
P	V
	2004
	6018
	6027
•	7035
	AMA
•	ANT
	AZZ
	1001
•	BIA
	BLU
	GIA
	MAR
•	MTZ
•	PAN
	RO3
	BIMCL
	NRMCL
•	OXI

Accessori per Fondali  
Back Panel Accessories

3.30

Coperchio doppi fondali metallo  
Top closer for double back panels

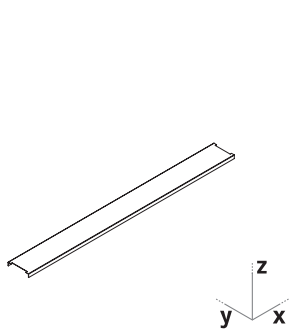

	x	y	z	codice code	note notes
piantana upright y=12	50	12,5	--	14.-91	
	66,5	12,5	--	14.-92	
	75	12,5	--	14.-90	
	100	12,5	--	14.-89	
	133	12,5	--	14.-93	

finitura finish	colori colours
P	V
	2004
	6018
	6027
•	7035
	AMA
•	ANT
	AZZ
	1001
•	BIA
	BLU
	GIA
	MAR
•	MTZ
•	PAN
	RO3
	BIMCL
	NRMCL
•	OXI

Accessori per Fondali  
Back Panel Accessories

3.31

Coperchio doppi fondali metallo con feritoia per comunicazione  
Top closer for double back panels with slot for communication

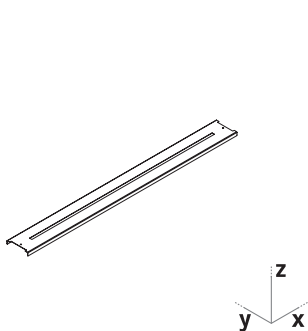

	x	y	z	codice code	note notes
piantana upright y=7,2	50	7,5	--	14.149	
	66,5	7,5	--	14.150	
	75	7,5	--	14.151	
	100	7,5	--	14.152	

finitura finish	colori colours	colori colours
	V	
	2004	MAR
	6018	• MTZ
	6027	• PAN
•	7035	RO3
	AMA	BIMCL
•	ANT	NRMCL
	AZZ	• OXI
	1001	
•	BIA	
	BLU	
	GIA	

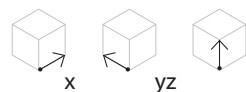
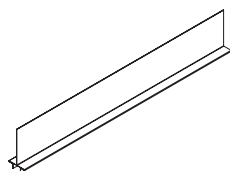

	x	yz		codice code	note notes
piantana upright y=7,2	50	7,51	5	14.144	
	66,57	,5	15	14.145	
	75	7,51	5	14.146	
	100	7,51	5	14.147	
piantana upright y=9	50	9,31	5	14.154	
	66,59	,3	15	14.155	
	75	9,31	5	14.156	
	100	9,31	5	14.157	
piantana upright y=7,2	50	7,51	0	14.462	
	66,57	,5	10	14.463	
	75	7,51	0	14.464	
	100	7,51	0	14.465	

finitura finish	colori colours
V	2004
	6018
	6027
	• 7035
	AMA
	• ANT
	AZZ
	1001
	• BIA
	BLU
	GIA
	MAR
	• MTZ
	• PAN
	RO3
	BIMCL
	NRMCL
	• OXI

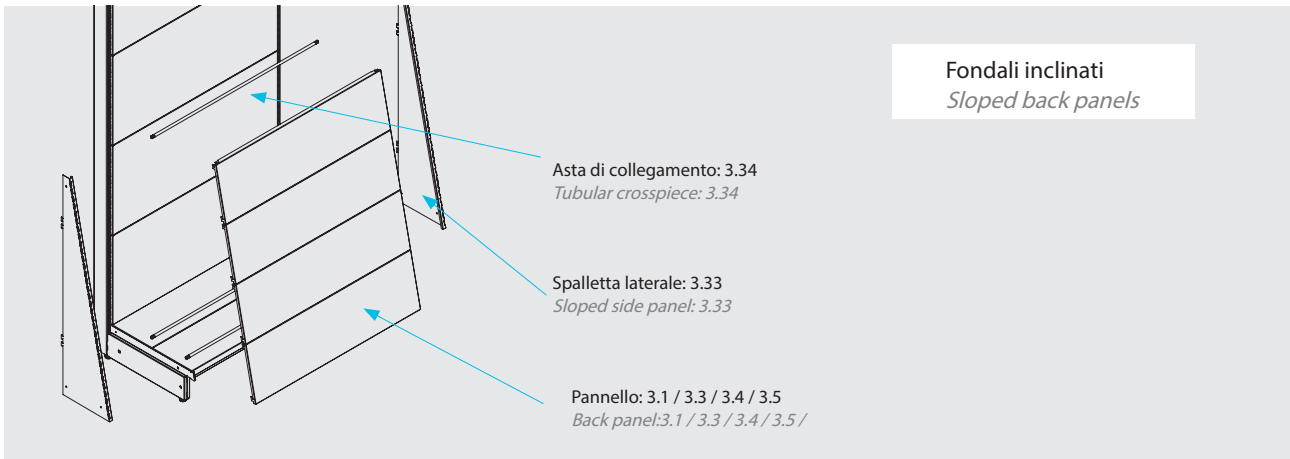

Accessori per Fondali / Back Panel Accessories **3.33** Spalletta laterale per fondali inclinati con base h 17/23 / Sloped side panel with h 17/23 high base

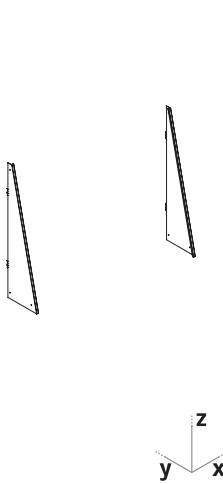

	x	y	z	codice / code	note / notes
dx rh	--	28	85	22.293	
sx lh	--	28	85	22.294	
dx rh	--	28	114	22.295	
sx lh	--	28	114	22.296	
dx rh	--	28	168	22.322	
sx lh	--	28	168	22.323	

finitura / finish	colori / colours
V	2004
	6018
	6027
	• 7035
	AMA
	• ANT
	AZZ
	1001
	• BIA
	BLU
	GIA
	MAR
	• MTZ
	• PAN
	RO3
	BIMCL
	NRMCL
	• OXI

Spalla 85 h si compone con 3 pannelli 29 h  
Side panel 85 cm high fits with three 29 cm high back panels

Spalla 114 h si compone con 4 pannelli da 29 h  
Side panel 114 cm high fits with four 29 cm high back panels

Spalla 168 h si compone con 3 pannelli da 47 h e 1 pannello da 29 h  
Side panel 168 cm high fits with three 47 cm high + one 29 cm high back panels

Accessori per Fondali / Back Panel Accessories **3.34** Asta di collegamento in tubo ø 1,2 / Tubular crosspiece ø 1,2 with screws

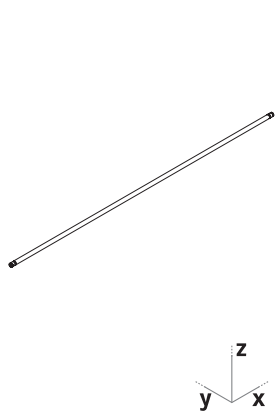

	x	y	z	codice / code	finitura colore / finish & colour	note / notes
	50	--	--	34.-24	C	
	66,5	--	--	34.234	C	
	75	--	--	34.-23	C	
	100	--	--	34.-22	C	
	133	--	--	34.120	C	



**note**  
*notes*

**note**  
*notes*

# Piani *Shelves*

# 4

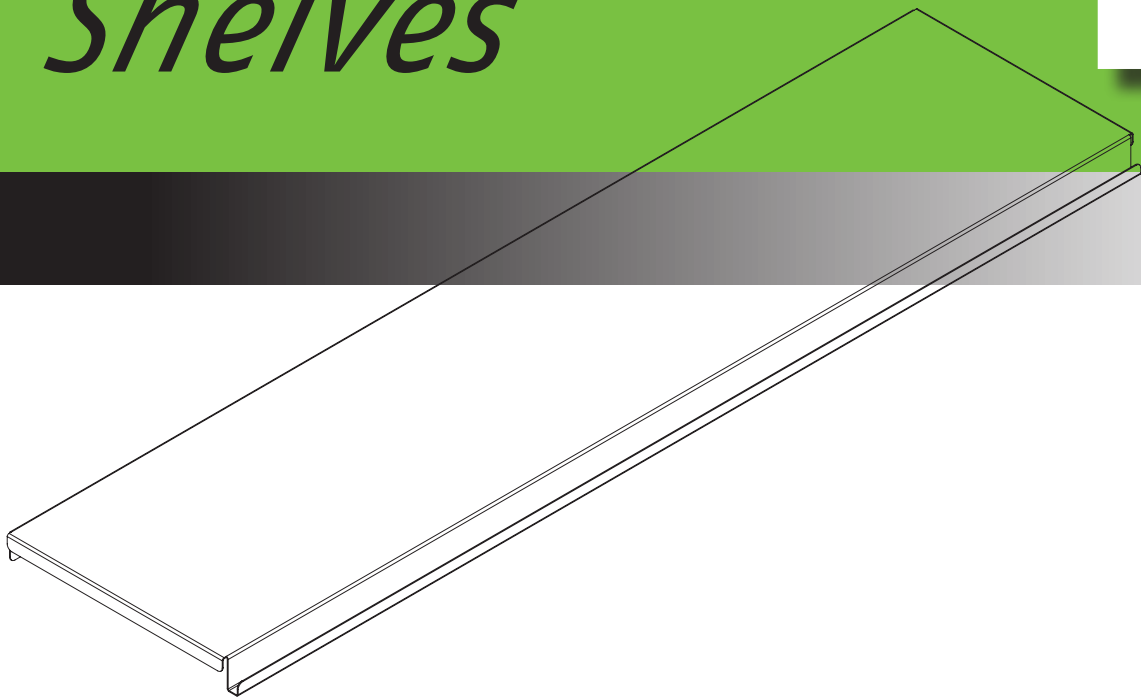

Piani a liste, piani interi, piani in filo, piani in vetro, piani speciali, piani a sbalzo e accessori: divisori, frontali e greche.

*Plank shelves, one piece shelves, wire shelves, particular shelves, overhanging shelves and accessories: dividers, fronts and grids.*



Piani in metallo, in vetro e in legno  
Metal, glass and wooden shelves

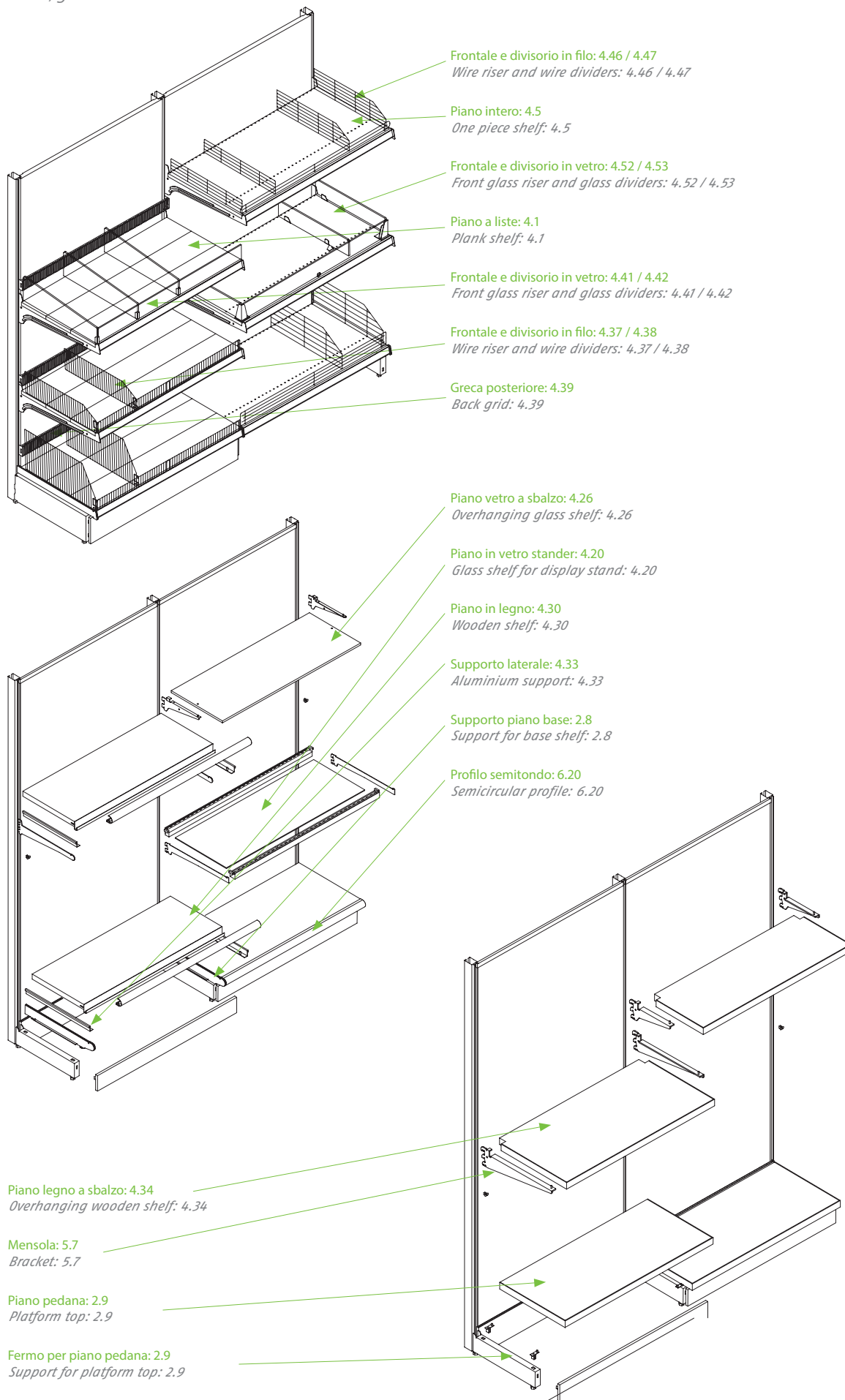

### Piani metallo ExtraSlim, piani Mini e ad "L" ExtraSlim Metal ExtraSlim, Mini and "L" ExtraSlim Shelf

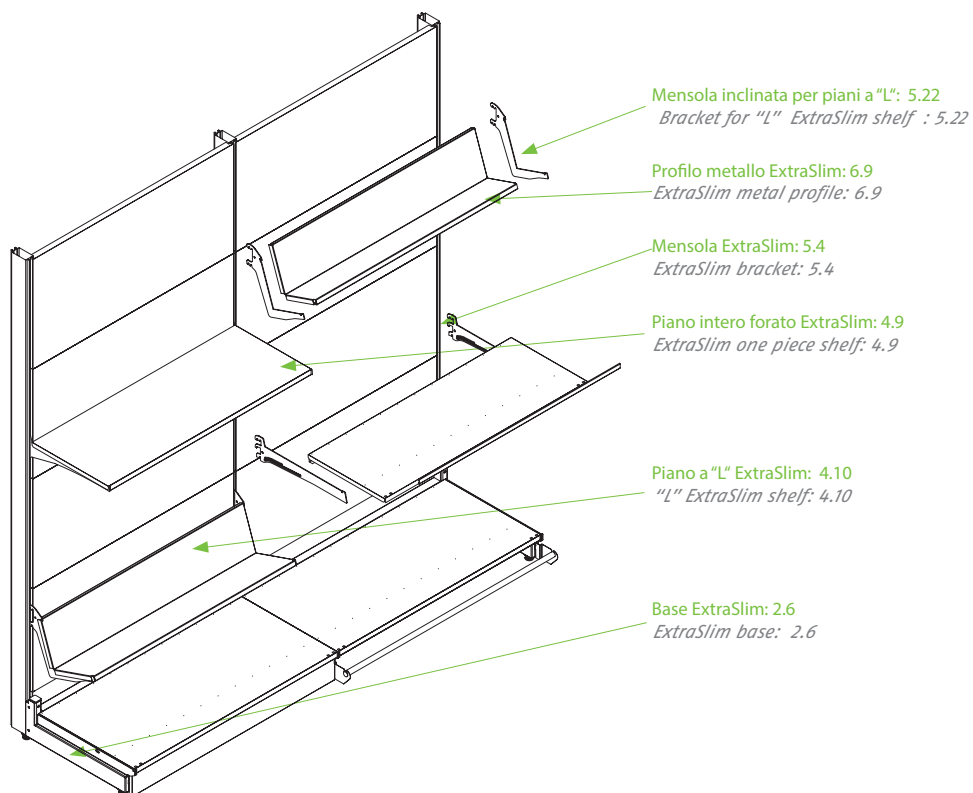

### Piani in filo e in vetro con supporti e traversini Wire and glass shelf with supports and crosspiece

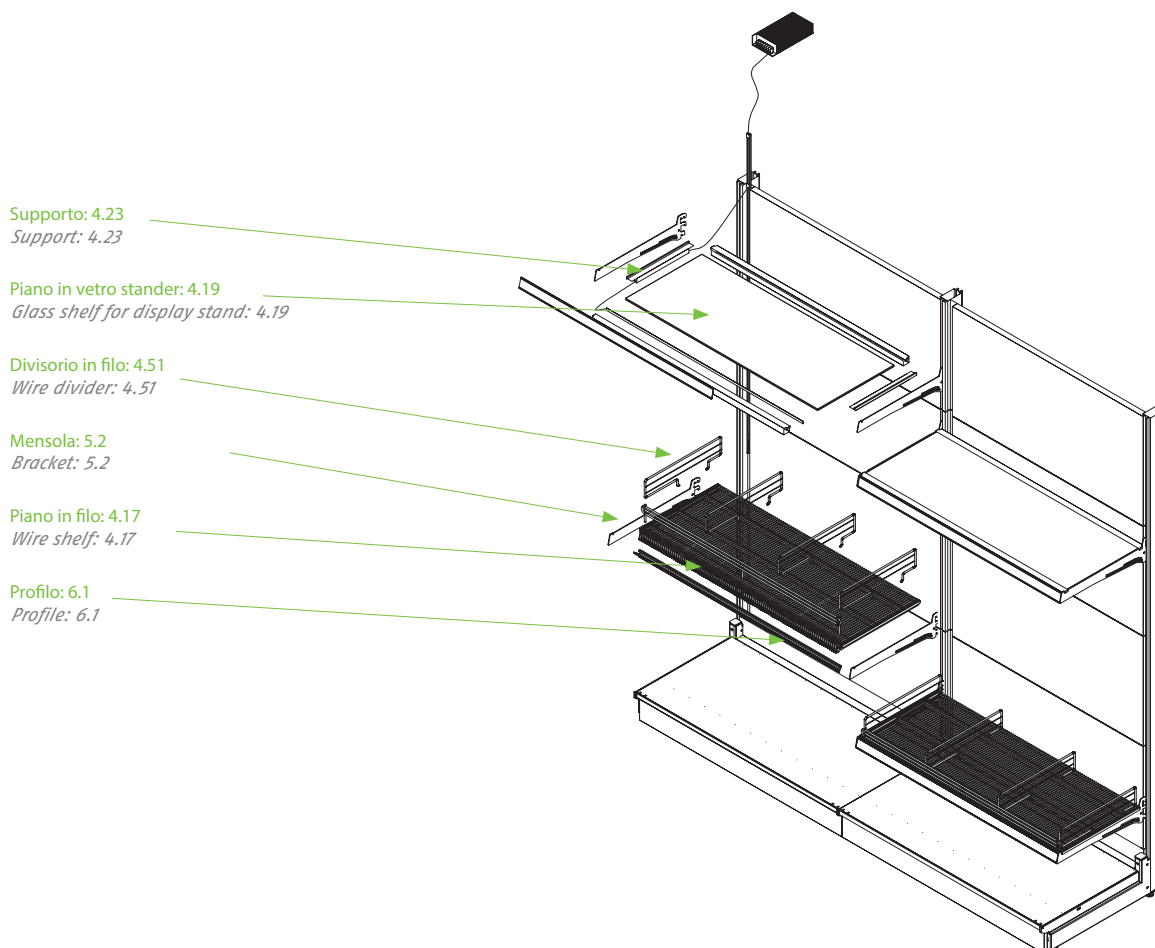

## Elemento ad angolo chiuso legno

*Wooden Closed corner unit*

Piano in legno per angolo chiuso con guida e supporti: 4.31  
*Wooden shelf for closed corner with runner and support: 4.31*

Piano a liste: 4.1  
*Plank shelf: 4.1*

Profilo semitondo per piani a liste: 6.20  
*Semicircular profile for plank shelf: 6.20*

Protezione in PVC per il profilo semitondo: 6.26  
*PVC protection for semicircular profiles: 6.26*

Mensola tipo slim a testa tonda: 5.1  
*Slim bracket with round head: 5.1*

Mensola tipo slim a testa inclinata: 5.1  
*Slim bracket with sloped head: 5.1*

Profilo in PVC inclinato per piani a liste: 6.1  
*PVC profile for plank shelf: 6.1*

Profilo in alluminio inclinato per piani a liste: 6.13  
*Aluminium profile for plank shelf: 6.13*

Striscia di finitura: 6.8  
*Finishing strip: 6.8*

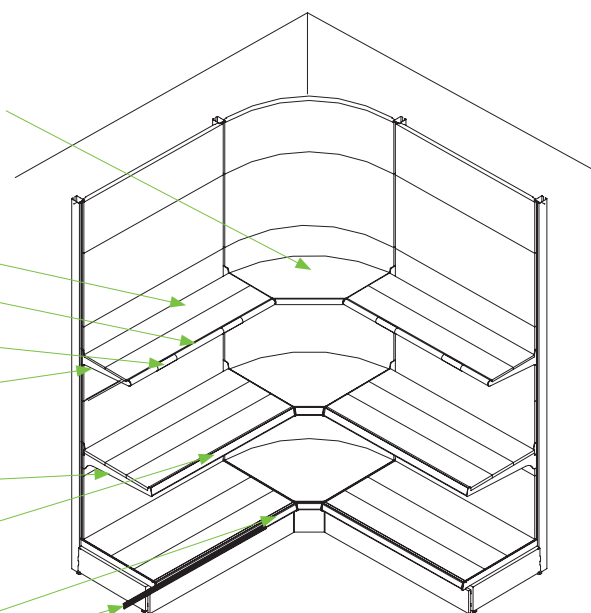

## Elemento ad angolo aperto legno

*Wooden open corner unit*

Piano in legno per angolo aperto con guida e supporti: 4.32  
*Wooden shelf for open corner with runner and profiles 4.32*

Piano a liste: 4.1  
*Plank shelf: 4.1*

Mensola stander: 5.6  
*Display stand bracket: 5.6*

Piano in vetro stander: 4.20  
*Glass shelf for display stand: 4.20*

Traverso cavettato: 4.22  
*Crosspiece: 4.22*

Mensola tipo slim a testa inclinata: 5.1  
*Slim bracket with sloped head: 5.1*

Profilo in PVC inclinato: 6.1  
*PVC profile: 6.1*

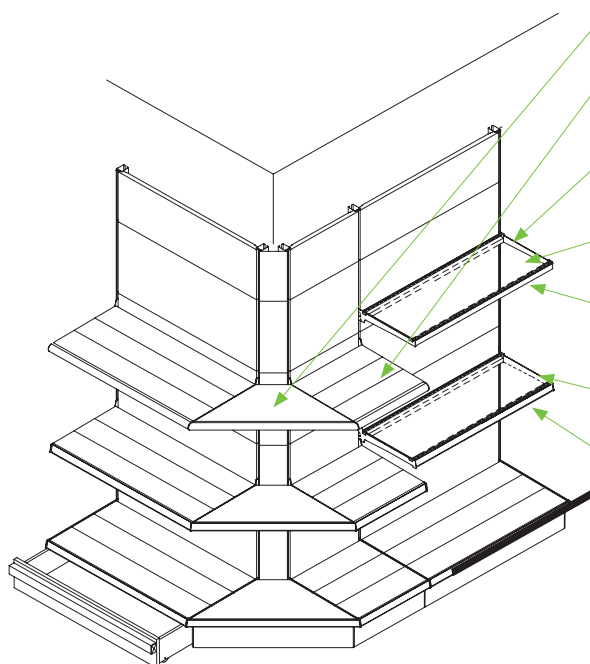

Elemento ad angolo chiuso 90° in metallo per basi h17/23  
*Metal closed corner unit for h 17/23 bases*

Piano metallo per angolo chiuso con portaprezzo PVC: 4.14  
*Metal shelf for closed corner with runner and support: 4.14*

Piano a liste: 4.1  
*Plank shelf: 4.1*

Profilo PVC testa inclinata per piani a liste: 6.1  
*PVC profile for plank shelf: 6.1*

Mensola tipo slim a testa inclinata: 5.1  
*Slim bracket with round head: 5.1*

Piano intero forato: 4.5  
*One piece shelf: 4.5*

Cassetto estraibile: 2.19  
*Pull out drawer: 2.19*

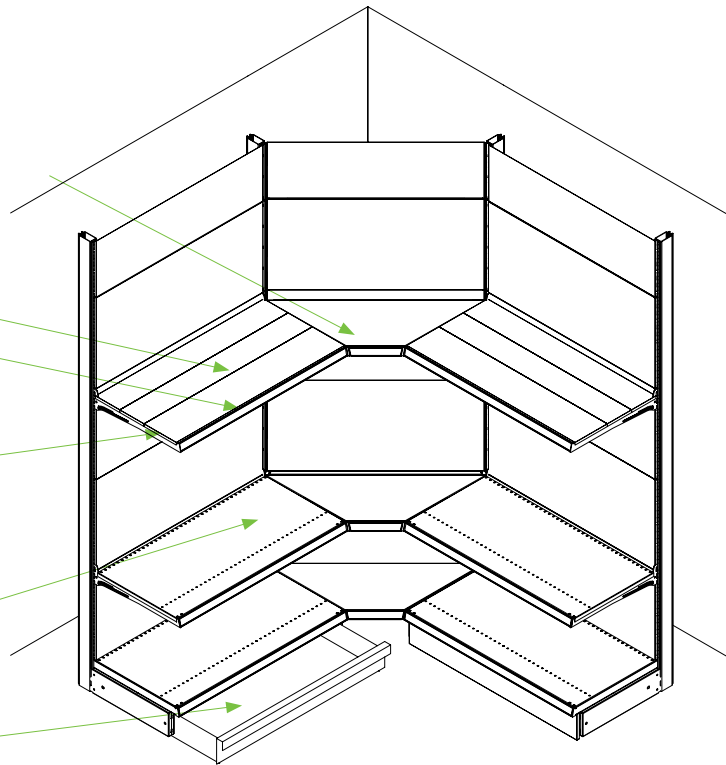

Elemento ad angolo aperto metallo per basi h 17/23  
*Metal open corner unit for h 17/23 bases*

Piano in filo con portaprezzo PVC inclinato: 4.17  
*Wire shelf with PVC profile: 4.17*

Piano in metallo per angolo aperto con portaprezzo PVC: 4.15  
*Metal shelf for open corner with PVC profile 4.15*

Mensola tipo nervata: 5.2  
*Bracket: 5.2*

Piano a liste: 4.1  
*Plank shelf: 4.1*

Profilo in PVC inclinato: 6.4  
*PVC profile: 6.4*

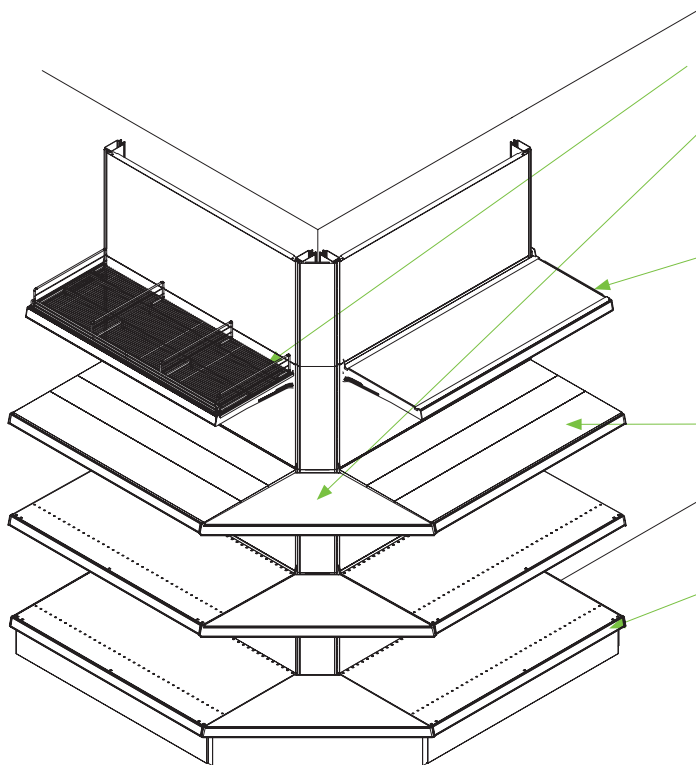





4.1

Piani a liste  
Plank shelf

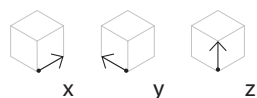
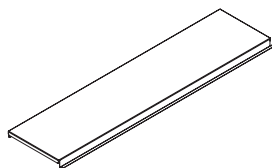

x	y	z	codice code	note notes
50	15	--	17.-07	
66,5	15	--	17.527	
75	15	--	17.-04	
100	15	--	17.-01	
133	15	--	17.-10	
50	20	--	17.-08	
66,5	20	--	17.528	
75	20	--	17.-05	
100	20	--	17.-02	
133	20	--	17.-11	
50	25	--	17.-09	
66,5	25	--	17.773	
75	25	--	17.-06	
100	25	--	17.-03	

finitura finish	colori colours
P	
	2004
	6018
	6027
•	7035
	AMA
	ANT
	AZZ
	1001
•	BIA
	BLU
	GIA
	MAR
•	MTZ
•	PAN
	RO3
	BIMCL
	NRMCL
	OXI

Composizione piani a liste  
Plank shelf setting

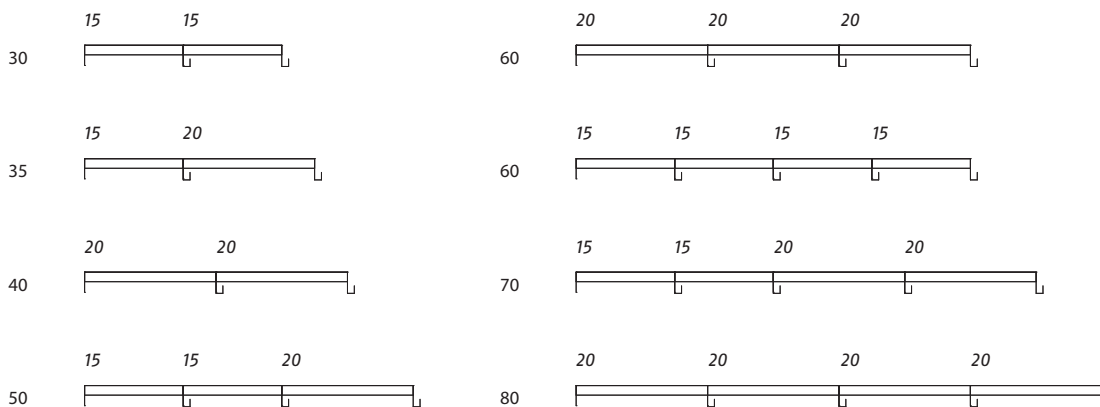

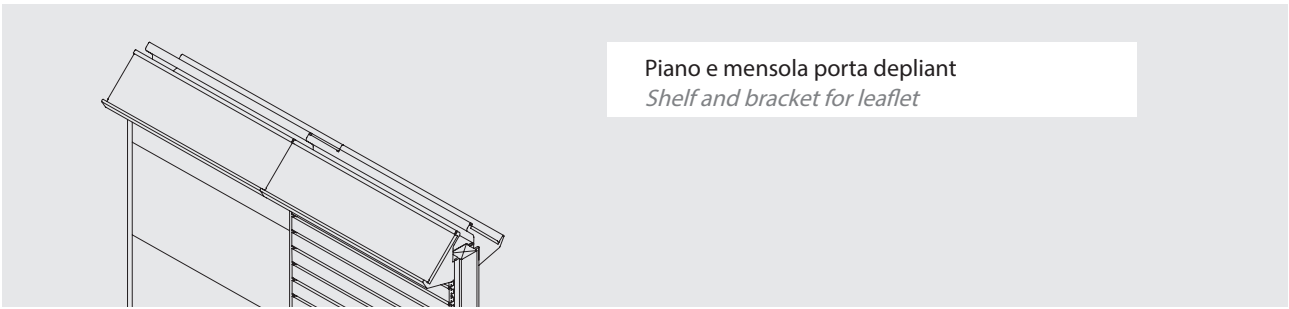

Piano e mensola porta depliant  
*Shelf and bracket for leaflet*

**Piani Shelves** 4.2 Piano porta depliant / videocassette e CD  
*Shelf for leaflets*

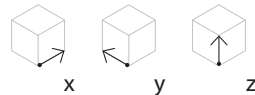
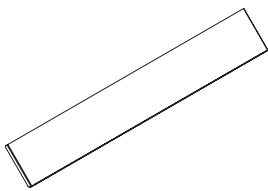

x	y	z	codice code	note notes
50	15	--	17.389	
75	15	--	17.388	
100	15	--	17.387	
133	15	--	17.604	

Mensola: 5.11  
Bracket: 5.11

finitura finish		colori colours	
P	V		
			2004
			6018
			6027
•			7035
			AMA
	•		ANT
			AZZ
			1001
•			BIA
			BLU
			GIA
			MAR
	•		MTZ
•			PAN
			RO3
			BIMCL
			NRMCL
	•		OXI

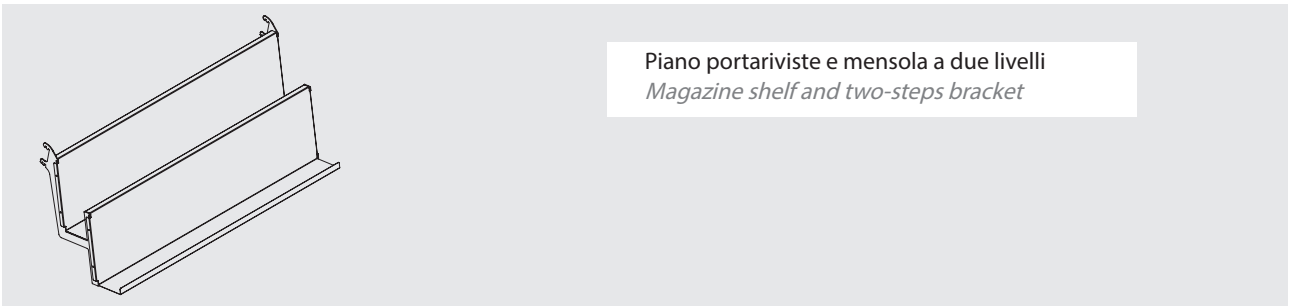

Piano portariviste e mensola a due livelli  
*Magazine shelf and two-steps bracket*

**Piani Shelves** 4.3 Piano portariviste  
*Magazine shelf*

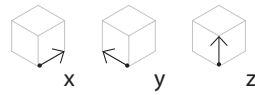
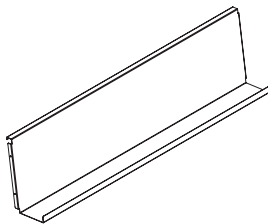

x	y	z	codice code	note notes
50	10	25	22.219	
75	10	25	22.211	
100	10	25	22.173	
133	10	25	22.317	

Mensola a due livelli: 5.23  
Two-steps bracket: 5.23

finitura finish		colori colours		colori colours	
	V				
			2004		MAR
			6018	•	MTZ
			6027	•	PAN
	•		7035		RO3
			AMA		BIMCL
	•		ANT		NRMCL
			AZZ	•	OXI
			1001		
	•		BIA		
			BLU		
			GIA		

Profilo portariviste e mensola, con frontale in vetro  
*Magazine holder profile, with bracket and glass riser*

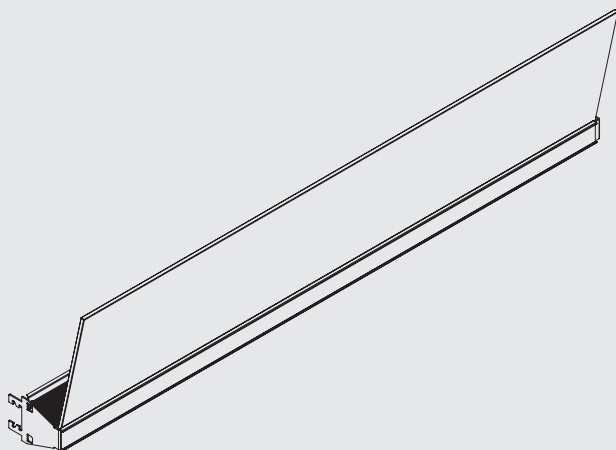

Piani  
Shelves

4.4

Profilo portariviste in alluminio  
*Magazine holder aluminium profile*

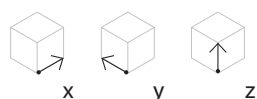
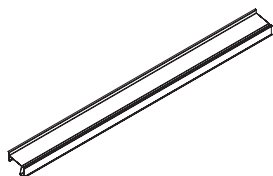

x	y	z	codice code	finitura e colore finish & colour	note notes
50	5,5	--	22.-62	N	
75	5,5	--	22.-61	N	
100	5,5	--	22.-60	N	

Mensola: 5.24  
 Bracket: 5.24

Frontale vetro temprato per espositore portariviste  
*Glass riser for magazine holder profile*

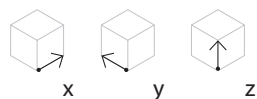
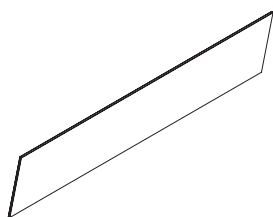

x	y	z	codice code	finitura e colore finish & colour	note notes
50	--	23	19.-55	NT	
75	--	23	19.-54	NT	
100	--	23	19.-53	NT	



4.5

Piano intero forato  
One piece shelf

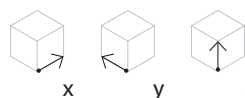
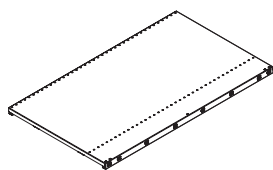

x	y	z	codice code	note notes
66,5	35	4	17.319	
100	35	4	17.313	
133	35	4	17.325	
66,5	40	4	17.320	
100	40	4	17.314	
133	40	4	17.326	
66,5	50	4	17.321	
100	50	4	17.315	
133	50	4	17.327	
66,5	60	4	17.322	
100	60	4	17.316	
133	60	4	17.328	

finitura finish	colori colours
V	2004
	6018
	6027
	• 7035
	AMA
	• ANT
	AZZ
	1001
	• BIA
	BLU
	GIA
	MAR
	• MTZ
	• PAN
	RO3
	BIMCL
	NRMCL
	• OXI

Composizione piani interi  
One piece shelf setting

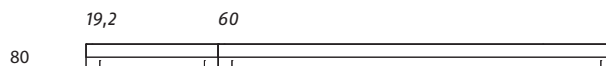
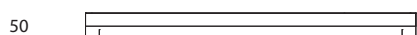
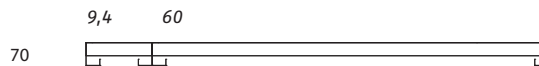
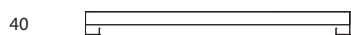
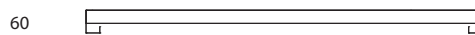
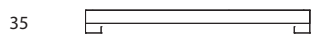

Piani  
Shelves

4.6

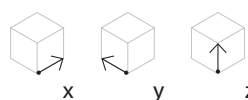
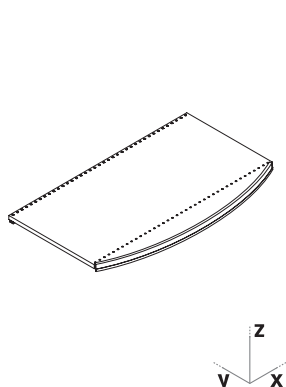
**Piano intero forato con bordo anteriore curvo**  
*One piece curved shelf*
codice  
codenote  
notesfinitura  
finishcolori  
colours

x	y	z	codice code	note notes
100	40	4	17.514	
133	40	4	17.515	
100	50	4	17.403	
133	50	4	17.402	

finitura finish	colori colours
V	2004
	6018
	6027
•	7035
	AMA
•	ANT
	AZZ
	1001
•	BIA
	BLU
	GIA
	MAR
•	MTZ
•	PAN
	RO3
	BIMCL
	NRMCL
•	OXI

Piani  
Shelves

4.7

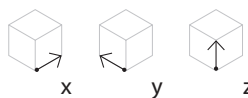
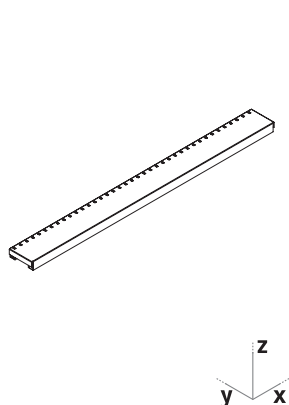
**Piano supplementare Minirack**  
*Additional Minirack shelf*
codice  
codenote  
notesfinitura  
finishcolori  
colours

x	y	z	codice code	note notes
66,5	9,4	--	17.347	
100	9,4	--	17.346	
133	9,4	--	17.348	
66,5	19,2	--	17.530	
100	19,2	--	17.437	
133	19,2	--	17.406	

finitura finish	colori colours
V	2004
	6018
	6027
•	7035
	AMA
•	ANT
	AZZ
	1001
•	BIA
	BLU
	GIA
	MAR
•	MTZ
•	PAN
	RO3
	BIMCL
	NRMCL
•	OXI

Da usare per comporre  
ripianti con profondità  
70/80 cm  
*To be used to create  
70/80 cm deep shelves*

Piani  
Shelves

4.8

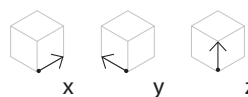
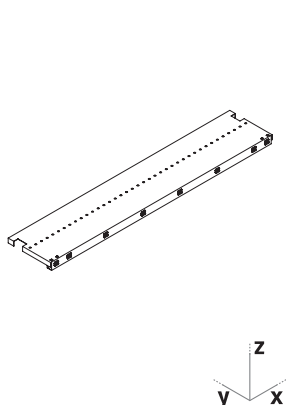
**Piano anteriore per Minirack arretrato**  
*Front Minirack shelf*
codice  
codenote  
notesfinitura  
finishcolori  
colourscolori  
colours

x	y	z	codice code	note notes
66,5	20	--	17.405	
100	20	--	17.401	
133	20	--	17.400	

finitura finish	colori colours	colori colours
V	2004	MAR
	6018	• MTZ
	6027	• PAN
•	7035	RO3
	AMA	BIMCL
•	ANT	NRMCL
	AZZ	• OXI
	1001	
•	BIA	
	BLU	
	GIA	

Mensola: 5.15  
Bracket: 5.15



4.9

Piano intero forato Extra Slim  
Extra Slim one piece shelf

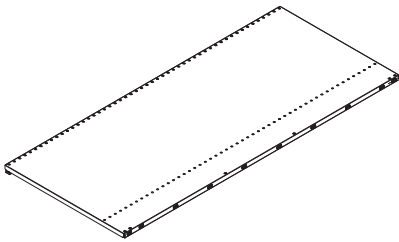

x	y	z	codice code	note notes
66,5	40	2	17.972	
100	40	2	17.964	
133	40	2	17.963	
66,5	50	2	17.956	
100	50	2	17.955	
133	50	2	17.951	
66,5	60	2	17.977	
100	60	2	17.952	
133	60	2	17.950	

finitura finish	colori colours
V	
	2004
	6018
	6027
	• 7035
	AMA
	• ANT
	AZZ
	1001
	• BIA
	BLU
	GIA
	MAR
	• MTZ
	• PAN
	RO3
	BIMCL
	NRMCL
	• OXI



4.10

Piano liscio mini- Extra Slim  
mini-Extra Slim one piece shelf

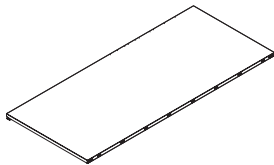

x	y	z	codice code	note notes
50	25	2	40.-04	
66,5	25	2	40.-03	
75	25	2	40.-02	
100	25	2	40.-01	
50	30	2	40.-08	
66,5	30	2	40.-07	
75	30	2	40.-06	
100	30	2	40.-05	

finitura finish	colori colours
V	
	2004
	6018
	6027
	• 7035
	AMA
	• ANT
	AZZ
	1001
	• BIA
	BLU
	GIA
	MAR
	• MTZ
	• PAN
	RO3
	BIMCL
	NRMCL
	• OXI

Non è possibile utilizzare frontali e divisori in filo.  
No wire front risers or dividers available

Piani  
Shelves

4.11

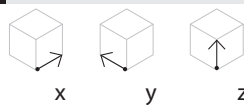
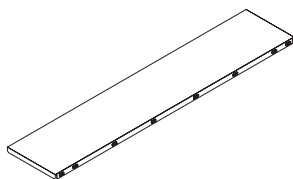
Piano liscio mini- Extra Slim per mensola a "L"  
mini-Extra Slim one piece shelf for "L" shaped brackets

x	y	z	codice code	note notes	finitura finish	colori colours	colori colours
100	15	2	17.988		V		
133	15	2	17.980			2004	MAR
						6018	• MTZ
						6027	• PAN
100	20	2	17.991			• 7035	RO3
						AMA	BIMCL
133	20	2	17.979			• ANT	NRMCL
						AZZ	• OXI
						1001	
						• BIA	
						BLU	
						GIA	

Mensola: 5.21  
Bracket: 5.21Piani  
Shelves

4.12

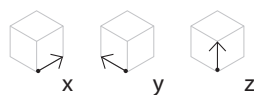
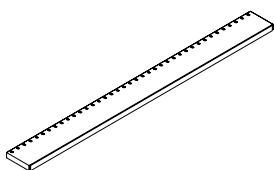
Piano supplementare forato Minirack Extra Slim  
Extra Slim additional Minirack shelf

x	y	z	codice code	note notes	finitura finish	colori colours	colori colours
66,5	19,2	--	17.998		V		
100	19,2	--	17.960			2004	
133	19,2	--	17.959			6018	
						6027	
						• 7035	
						AMA	
						• ANT	
						AZZ	
						1001	
						• BIA	
						BLU	
						GIA	
						MAR	
						• MTZ	
						• PAN	
						RO3	
						BIMCL	
						NRMCL	
						• OXI	

Da usare per comporre  
ripiani con profondità  
70/80 cm  
To be used to create  
70/80 cm deep shelvesPiani  
Shelves

4.13

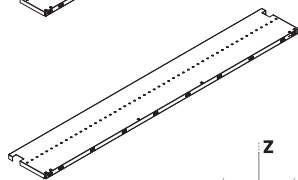
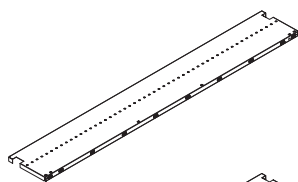
Piano anteriore forato per Minirack arretrato Extra Slim  
Extra Slim front Minirack shelf

x	yz	z	codice code	note notes	finitura finish	colori colours	colori colours
66,52	0-	-	17.978	per piani di base	V		
100	20	--	17.957			2004	MAR
133	20	--	17.958			6018	• MTZ
						6027	• PAN
						• 7035	RO3
						AMA	BIMCL
66,52	0-	-	40.297	per piani sospesi		• ANT	NRMCL
100	20	--	40.298			AZZ	• OXI
133	20	--	40.299			1001	
						• BIA	
						BLU	
						GIA	

Mensola: 5.18  
Bracket: 5.18



4.14

Piano in metallo per angolo chiuso 90°  
*Metal shelf for closed corner*

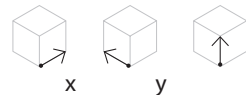
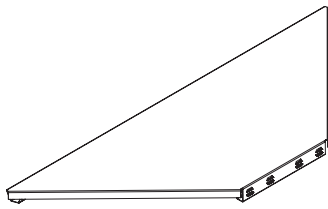

	x	y	z	codice code	note notes
--	25	3,9	40.-09		
--	30	3,9	40.-10		
--	35	3,9	40.-11		
--	40	3,9	40.-12		
--	50	3,9	40.-13		
--	60	3,9	40.-14		

finitura finish	colori colours	colori colours
V	2004	MAR
	6018	• MTZ
	6027	• PAN
	• 7035	RO3
	AMA	BIMCL
	• ANT	NRMCL
	AZZ	• OXI
	1001	GIA
	• BIA	
	BLU	

Solo per base h17 h23  
*For base only h17 h23*



4.15

Piano in metallo per angolo aperto  
*Metal shelf for opened corner*

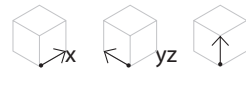
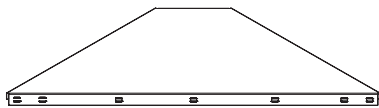

	x	yz	z	codice code	note notes
--	25	3,9	40.-15		per piani di base
--	30	3,9	40.-16		
--	35	3,9	40.-17		
--	40	3,9	40.-18		
--	50	3,9	40.-19		
--	60	3,9	40.-20		
--	30	3,9	40.287		per piani sospesi
--	40	3,9	40.284		
--	50	3,9	40.285		
--	60	3,9	40.286		

finitura finish	colori colours	colori colours
V	2004	MAR
	6018	• MTZ
	6027	• PAN
	• 7035	RO3
	AMA	BIMCL
	• ANT	NRMCL
	AZZ	• OXI
	1001	GIA
	• BIA	
	BLU	

Solo per piano base, utilizzare h17 h23  
*For base only h17 h23*

Accessori per Piani  
*Shelving Accessories*

4.16

Supporto laterale per piano base angolo chiuso in metallo  
*Support for closed metal shelves on foot-base*

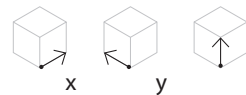
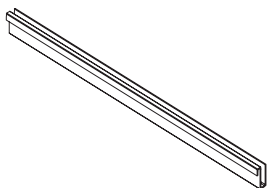

	x	y	z	codice code	note notes
--	25	3,9	11.108		
--	30	3,9	11.109		
--	35	3,9	11.110		
--	40	3,9	11.111		
--	50	3,9	11.112		
--	60	3,9	11.113		

finitura finish	colori colours	colori colours
V	2004	MAR
	6018	• MTZ
	6027	• PAN
	• 7035	RO3
	AMA	BIMCL
	• ANT	NRMCL
	AZZ	• OXI
	1001	GIA
	• BIA	
	BLU	

Solo per piani base angolo chiuso: 4.14  
*Only for closed corner shelves: 4.14*



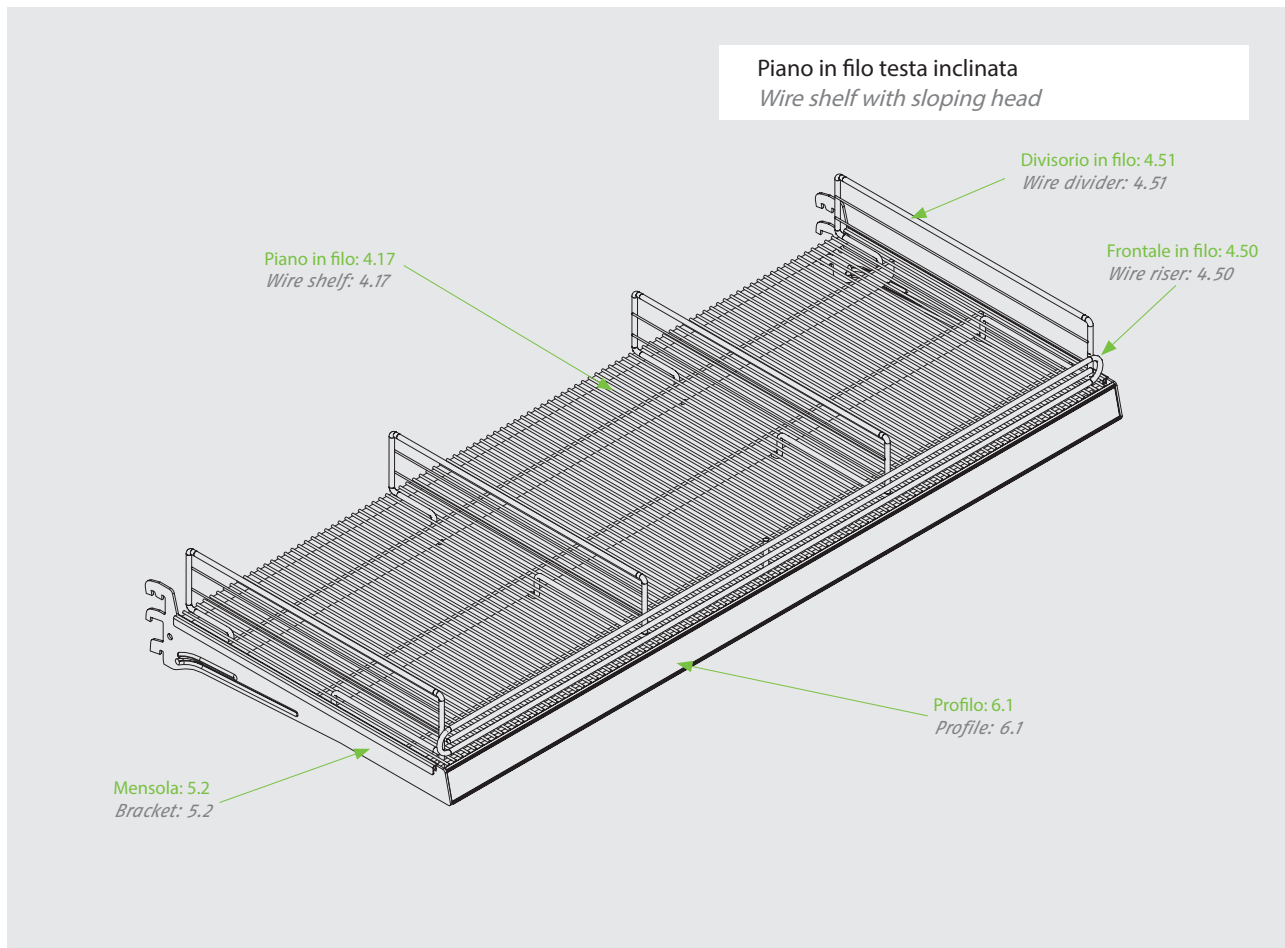

**Piani Shelves** **4.17** **Piano in filo Wire shelf**

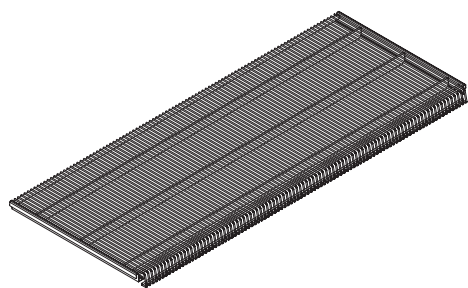

x	y	z	codice code	finitura e colore finish & colour	note notes	finitura finish	colori colours
66,5	30	4	22.554			V	
100	30	4	22.522				2004
133	30	4	22.525				6018
							6027
							• 7035
							AMA
							• ANT
							AZZ
66,5	40	4	22.556				1001
100	40	4	22.523				• BIA
133	40	4	22.526				BLU
							GIA
							MAR
							• MTZ
							• PAN
							RO3
66,5	50	4	22.534				BIMCL
100	50	4	22.524				NRMCL
133	50	4	22.527				• OXI

Profilo: 6.1  
Profile: 6.1

Piano in filo inclinabile e mensola  
*Wire shelf with bracket*

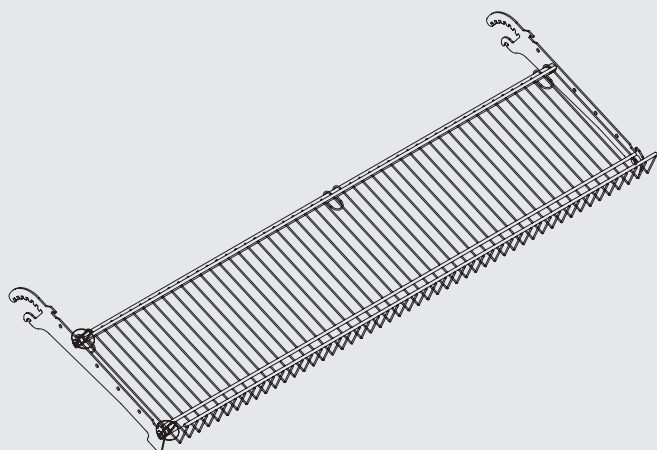

Piani  
Shelves

4.18

Piano in filo inclinabile  
*Wire shelf*

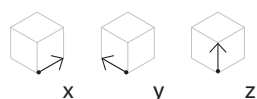
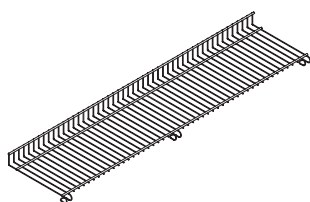

x	y	z	codice code	finitura e colore finish & colour	note notes
50	25	--	22.-99	C	
75	25	--	22.-98	C	
100	25	--	22.-97	C	

Traverso di collegamento in tubo  $\varnothing$  1,2 cm con bussole e viti  
*Tubular crosspiece  $\varnothing$  1,2 cm with screws*

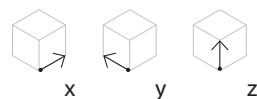
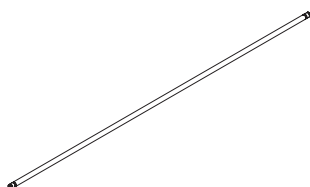

x	y	z	codice code	finitura e colore finish & colour	note notes
50	--	--	34.-24	C	
75	--	--	34.-23	C	
100	--	--	34.-22	C	

Mensola: 5.5  
Bracket: 5.5

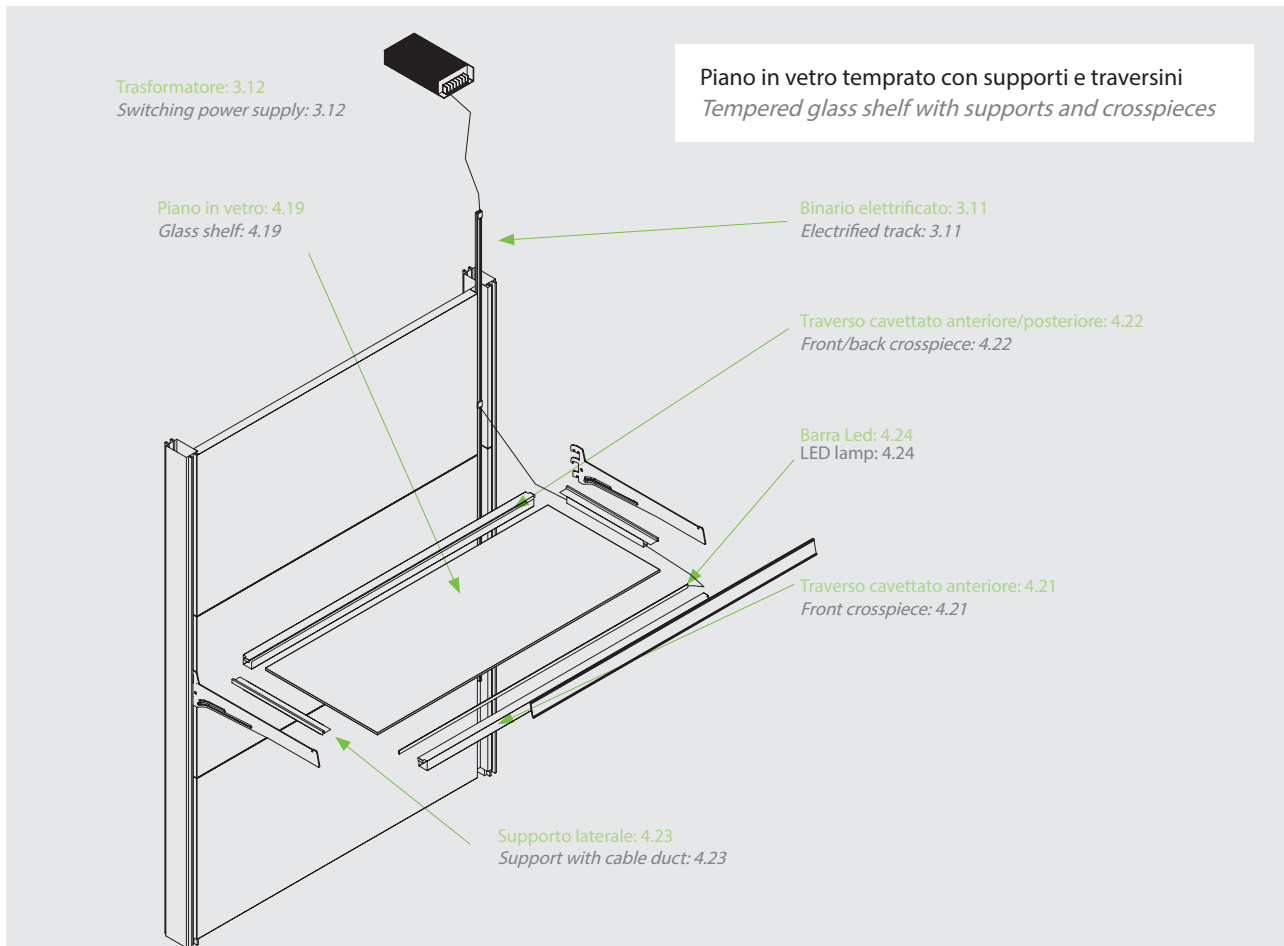

**Piani Shelves** **4.19** **Piano in vetro temprato**  
*Tempered glass shelf*

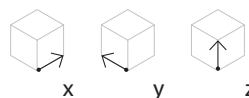
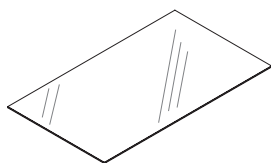

x	y	z	codice code	note notes
50	40	0,6	17.590	
66,5	40	0,6	17.344	
75	40	0,6	17.673	
100	40	0,6	17.531	
133	40	0,6	17.532	
50	50	0,6	17.591	
66,5	50	0,6	17.412	
75	50	0,6	17.589	
100	50	0,6	17.411	
133	50	0,6	17.410	
66,5	60	0,6	17.409	
100	60	0,6	17.408	
133	60	0,6	17.407	

finitura finish		colori colours
T	N	
•		BIAT
	•	T

Piano in vetro stander temprato con traversini  
Display stand tempered glass shelf with crosspieces

Piano in vetro stander: 4.20  
Glass shelf for display stand: 4.20

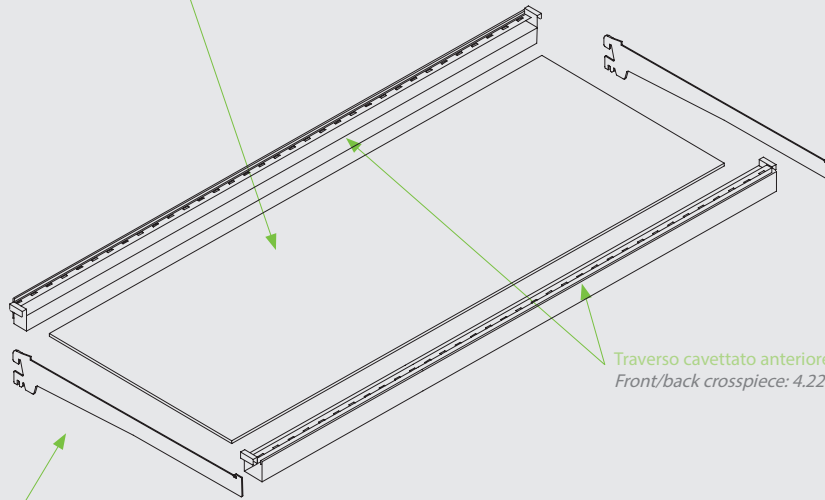

Traverso cavettato anteriore/posteriore: 4.22  
Front/back crosspiece: 4.22

Mensola stander: 5.6  
Display stand brackets: 5.6



Piani  
Shelves

4.20

Piano in vetro stander temprato  
Tempered glass shelf for display stand

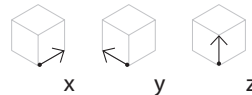
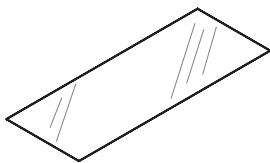

x	y	z	codice code	note notes
73,8	23,2	--	17.670	
98,8	23,2	--	17.666	
73,8	28	--	17.671	
98,8	28	--	17.667	
73,8	32,8	--	17.672	
98,8	32,8	--	17.668	
73,8	37,6	--	17.673	
98,8	37,6	--	17.531	

finitura finish		colori colours
T	N	
•		BIAT
	•	T

Mensola stander: 5.6  
Display stand bracket: 5.6



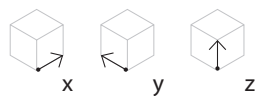
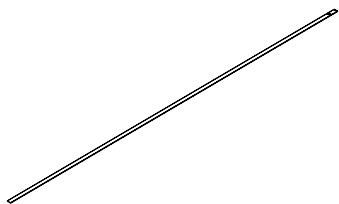

	x	y	z	codice code	note notes	finitura e colore finish & colour
48	--	--	--	20.458	7 W - 12 V	LED
64	--	--	--	20.459	9 W - 12 V	LED
98	--	--	--	20.460	14,4 W - 12 V	LED
130	--	--	--	20.461	19 W - 12 V	LED



Ferma cavo con magnete  
Magnetic wire stopper

codice code	note notes
34.665	

Piano espositivo in vetro temperato con mensola e traverso  
*Tempered glass display shelf with brackets and crosspieces*

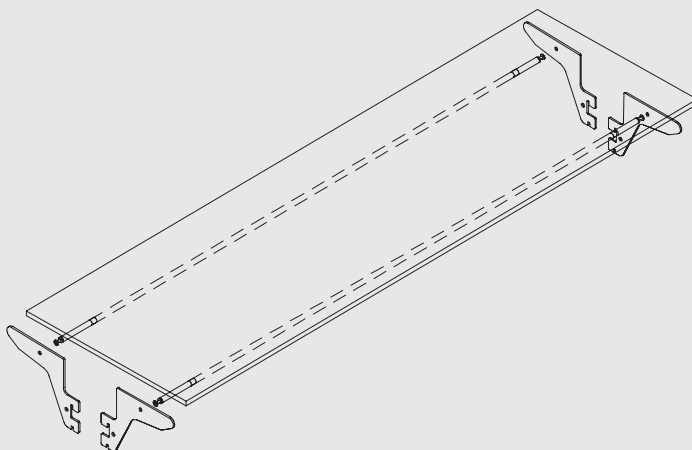

4.25

Piano espositivo in vetro temperato  
*Tempered glass display shelf*

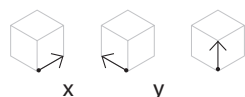
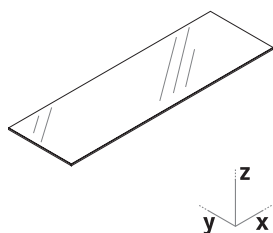

x	y	z	codice code	note notes
48,8	30,8	0,8	17.749	
73,8	30,8	0,8	17.750	
98,8	30,8	0,8	17.539	

finitura finish		colori colours
T	NT	
•		BIAT
	•	--

Mensola: 5.12  
 Bracket: 5.12

Traverso porta piano espositivo con anelli in PVC  
*Crosspiece for glass display shelf with PVC rings*

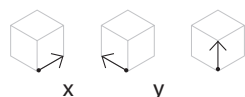
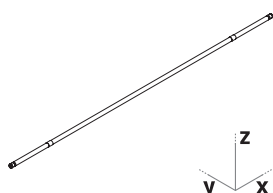

x	y	z	codice code	note notes
50	--	--	34.390	
75	--	--	34.389	
100	--	--	34.388	

finitura finish		colori colours
C	V	
		2004
		6018
		6027
	•	7035
		AMA
	•	ANT
		AZZ
		1001
	•	BIA
		BLU
		GIA
		MAR
	•	MTZ
	•	PAN
		RO3
		BIMCL
		NRMCL
	•	OXI
•		---

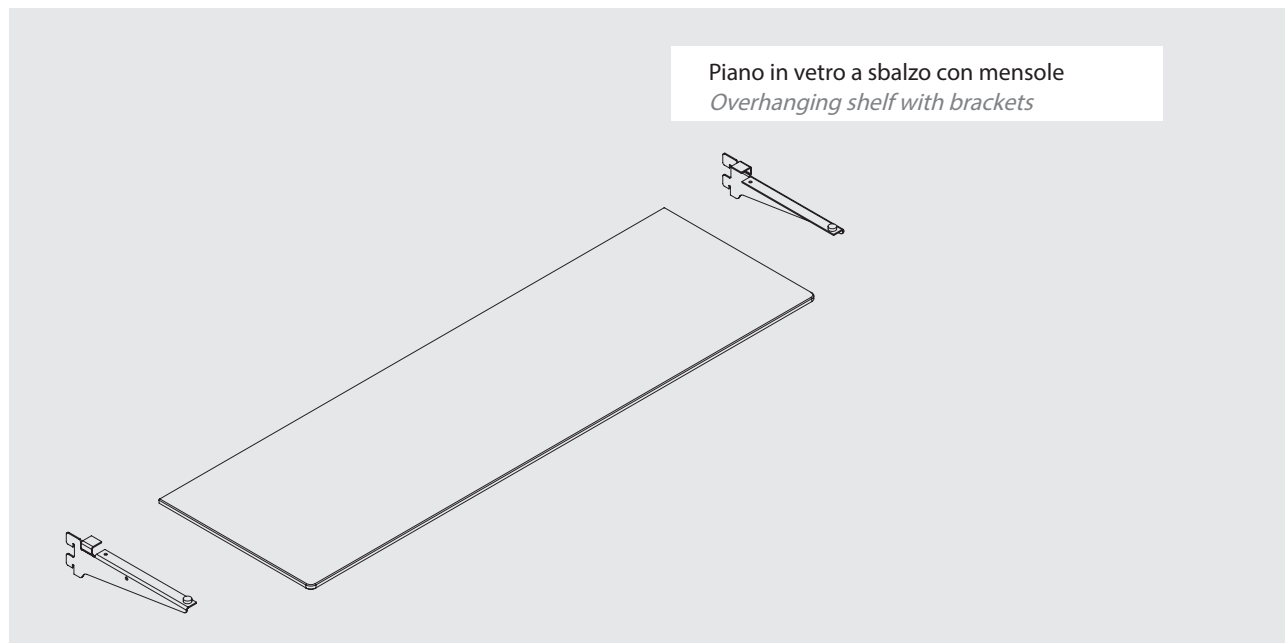

**Piani Shelves** 4.26 Piano vetro temprato a sbalzo 8mm con foro cieco  
Overhanging tempered glass shelf 8mm thick

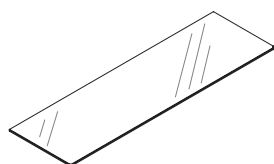

x	y	z	codice code	note notes
50	25	0,8	17.751	
75	25	0,8	17.676	
100	25	0,8	17.605	
50	30	0,8	17.631	
75	30	0,8	17.537	
100	30	0,8	17.535	
50	35	0,8	17.632	
75	35	0,8	17.538	
100	35	0,8	17.536	
50	40	0,8	17.747	
75	40	0,8	17.748	
100	40	0,8	17.607	

finitura finish		colori colours
T	NT	BIAT
•		
	•	--

Mensola: 5.8  
Bracket: 5.8



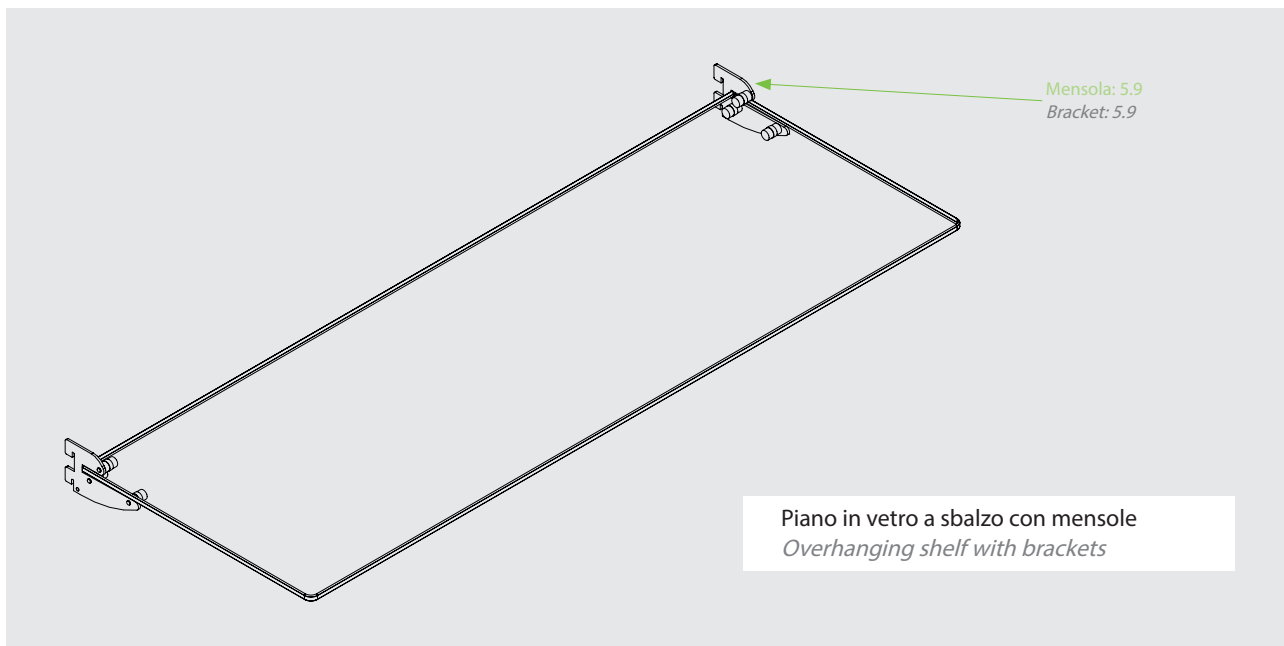

**Piani Shelves** 4.27 Piano vetro temprato a sbalzo 8mm  
Overhanging tempered glass shelf 8mm thick

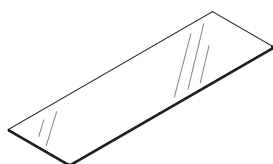

x	y	z	codice code	note notes
50	20	0,8	40.170	
75	20	0,8	40.171	
100	20	0,8	40.172	
50	25	0,8	40.-75	
75	25	0,8	40.157	
100	25	0,8	40.-80	
50	30	0,8	40.-81	
75	30	0,8	40.-83	
100	30	0,8	40.-84	

finitura finish	colori colours
NT	

Mensola: 5.9  
Bracket: 5.9

Piano in vetro a sbalzo temprato 10 mm con mensole e traverso posteriore  
Overhanging tempered glass shelf 10 mm thick with brackets and back crosspiece

Traverso posteriore in alluminio: 4.28  
Back aluminium crosspiece: 4.28

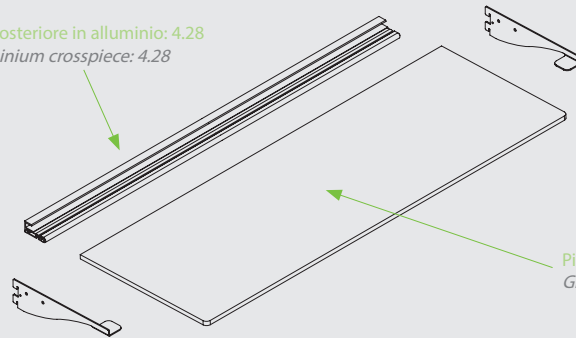

Mensola dx: 5.10  
Rh bracket: 5.10

Piano in vetro: 4.28  
Glass shelf: 4.28

Mensola sx: 5.10  
Lh bracket: 5.10



Piani  
Shelves

4.28

Piano vetro a sbalzo temprato 10 mm per traverso posteriore  
Overhanging tempered glass shelf 10 mm thick for back crosspiece

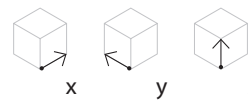
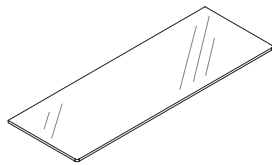

x	y	z	codice code	note notes
50	35	1	17.776	
75	35	1	17.777	
100	35	1	17.778	

finitura finish	colori colours
T	
•	BIAT
	--

Mensola: 5.10  
Bracket: 5.10

Traverso posteriore in alluminio per piano vetro a sbalzo  
Back aluminium crosspiece for glass overhanging shelf

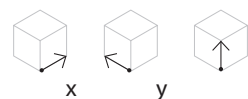
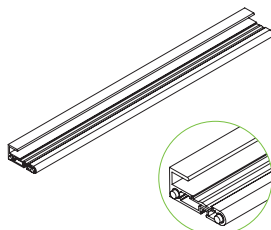

x	y	z	codice code	note notes
50	--	--	34.496	
75	--	--	34.501	
100	--	--	34.502	

finitura finish	colori colours
V	
	2004
	6018
	6027
•	7035
	AMA
•	ANT
	AZZ
	1001
•	BIA
	BLU
	GIA
	MAR
•	MTZ
•	PAN
	RO3
	BIMCL
	NRMCL
•	OXI

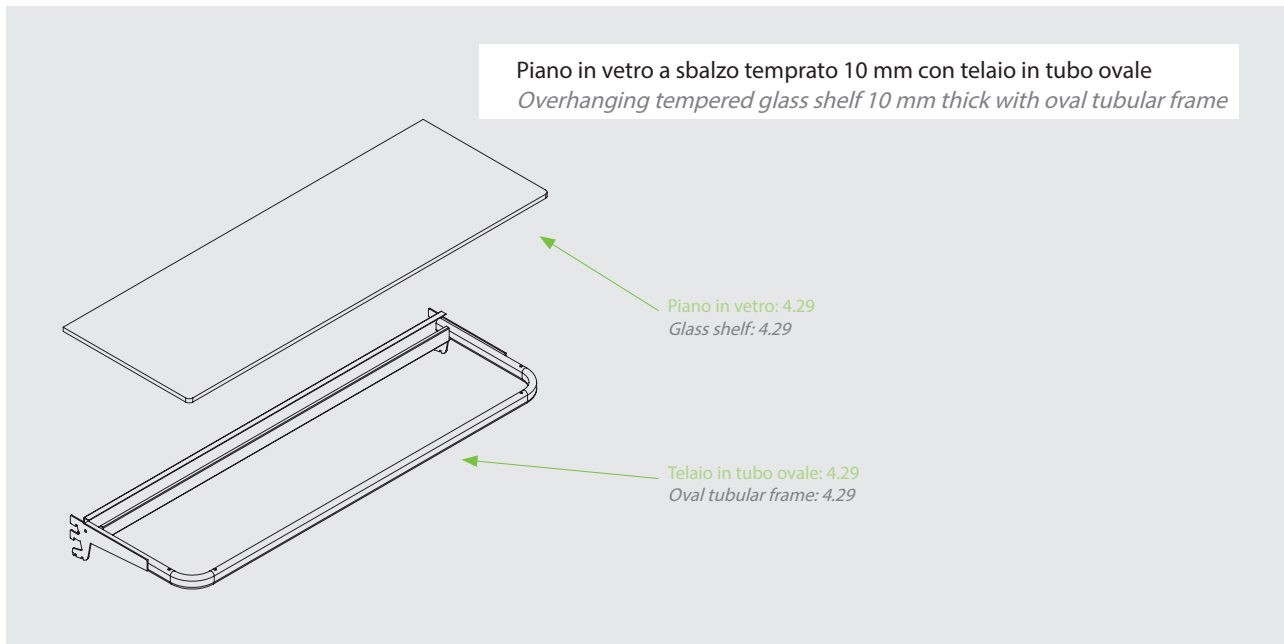

**Piani Shelves** 4.29 **Piano vetro a sbalzo temprato 10mm per telaio tubo ovale**  
*Overhanging tempered glass shelf 10mm thick for oval tubular frame*

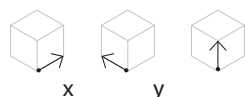
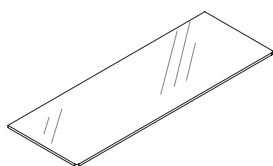

x	y	z	codice code	note notes
66,5	35	1	17.746	
75	35	1	17.714	
100	35	1	17.713	
133	35	1	17.719	

finitura finish	colori colours
T	
•	BIAT
	--

**Telaio tubo ovale con mensole e ventose per piano vetro**  
*Oval tubular frame with brackets and suction caps for glass shelf*

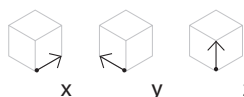
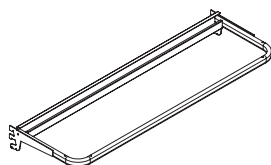

x	y	z	codice code	note notes
66,5	30	--	34.500	
75	30	--	34.485	
100	30	--	34.484	
133	30	--	34.490	

finitura finish	colori colours
V	
	2004
	6018
	6027
•	7035
	AMA
•	ANT
	AZZ
	1001
•	BIA
	BLU
	GIA
	MAR
•	MTZ
•	PAN
	RO3
	BIMCL
	NRMCL
•	OXI

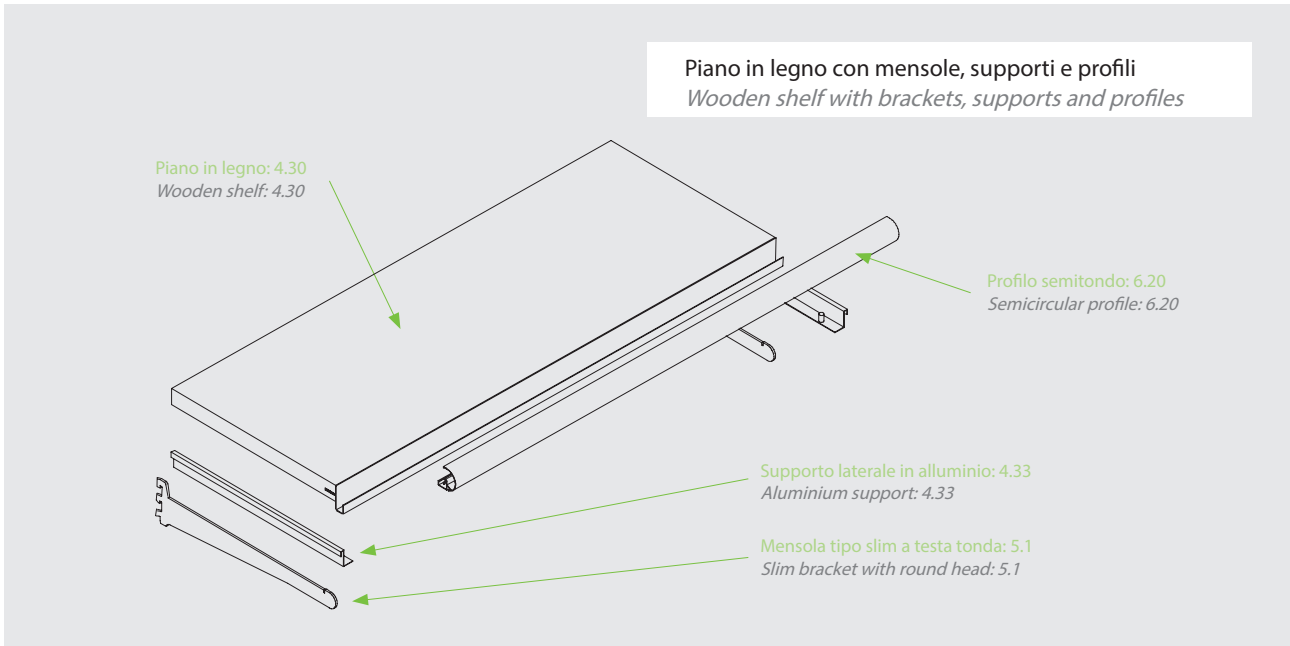

**Piani Shelves** **4.30** **Piano in legno con guida per profili porta prezzo**  
*Wooden shelf with runner for profiles*

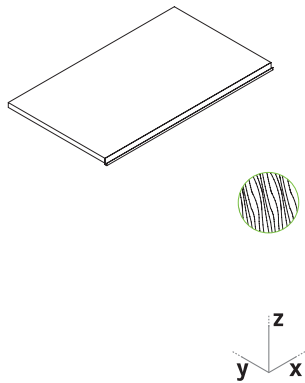

x	y	z	codice code	note notes	finitura finish	colori colours
50	30	2,5	17.651		T	7035
75	30	2,5	17.646		•	ACE
100	30	2,5	17.641		•	BIA
						FAG
					•	MTZ
					•	PAN
					•	A439
					•	ANT
50	35	2,5	17.652			K101
75	35	2,5	17.647			3813
100	35	2,5	17.642			2293
						990XA
						990XM
						A838
						999XA
						995XM
50	40	2,5	17.653			989XR
75	40	2,5	17.648			994XS
100	40	2,5	17.643			997XS
						983XR
						984XA
						BLACK
						GREEN
						BEIGE
						WHITE
50	50	2,5	17.654			
75	50	2,5	17.649			
100	50	2,5	17.644			
50	60	2,5	17.655			
75	60	2,5	17.650			
100	60	2,5	17.645			

Piani  
Shelves

4.31

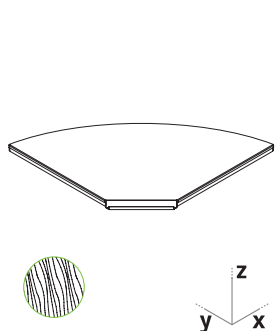
**Piano in legno per angolo chiuso con guida e supporti**  
*Wooden shelf for closed corner with runner and supports*

	x	y	z	codice code	note notes	finitura finish	colori colours	colori colours	colori colours
	--	25	2,5	17.576		<b>T</b>			
	--	30	2,5	17.577		• 7035	3813	997XS	
	--	35	2,5	17.578		• ACE	2293	983XR	
	--	40	2,5	17.579		• BIA	990XA	984XA	
	--	50	2,5	17.580		• FAG	990XM	BLACK	
	--	60	2,5	17.581		• MTZ	A838	GREEN	
						• PAN	999XA	BEIGE	
						• A439	995XM	WHITE	
						• ANT	989XR		
						K101	994XS		

Non adatto come piano per base H12

Piani  
Shelves

4.32

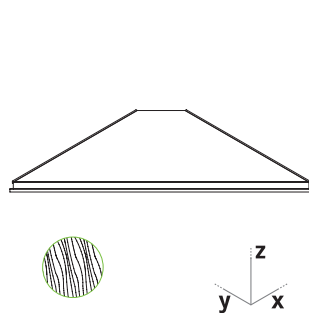
**Piano in legno per angolo aperto con guida e supporti**  
*Wooden shelf for open corner with runner and supports*

	x	y	z	codice code	note notes	finitura finish	colori colours	colori colours	colori colours
	--	25	2,5	17.582		<b>T</b>			
	--	30	2,5	17.583		• 7035	3813	997XS	
	--	35	2,5	17.584		• ACE	2293	983XR	
	--	40	2,5	17.585		• BIA	990XA	984XA	
	--	50	2,5	17.586		• FAG	990XM	BLACK	
	--	60	2,5	17.587		• MTZ	A838	GREEN	
						• PAN	999XA	BEIGE	
						• A439	995XM	WHITE	
						• ANT	989XR		
						K101	994XS		

Non adatto come piano per base H12

Accessori per Piani  
Shelving Accessories

4.33

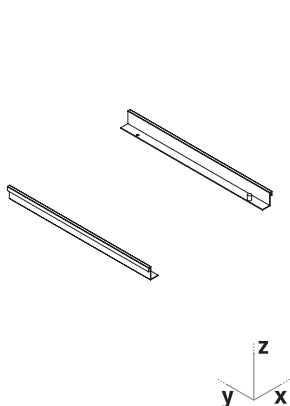
**Supporto laterale in alluminio con piolino per piano in legno**  
*Aluminium support for wooden shelves*

	x	y	z	codice code	note notes	finitura finish	colori colours
dx rh	--	30	2,5	18.119		<b>T</b>	
sx lh	--	30	2,5	18.120		•	7035
						•	ACE
						•	BIA
						•	FAG
						•	MTZ
						•	PAN
						•	A439
						•	ANT
							K101
							3813
							2293
							990XA
							990XM
							A838
							999XA
							995XM
							989XR
							994XS
							997XS
							983XR
							984XA
							BLACK
							GREEN
							BEIGE
							WHITE
dx rh	--	35	2,5	18.121			
sx lh	--	35	2,5	18.122			
dx rh	--	40	2,5	18.123			
sx lh	--	40	2,5	18.124			
dx rh	--	50	2,5	18.125			
sx lh	--	50	2,5	18.126			
dx rh	--	60	2,5	18.127			
sx lh	--	60	2,5	18.128			

Piani: 4.21  
Shelves: 4.21



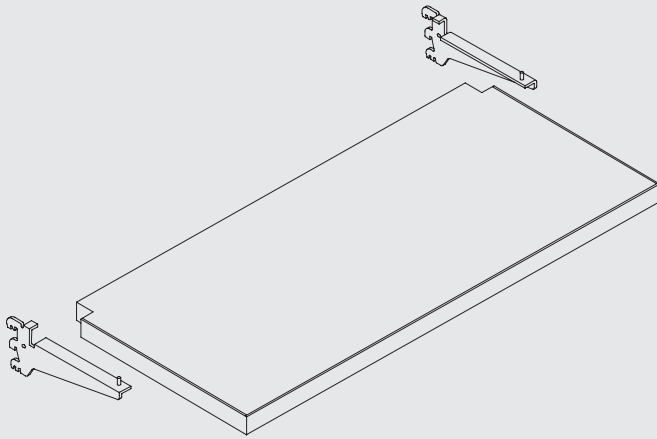



Piano in legno a sbalzo con mensole  
Overhanging wooden shelf with brackets

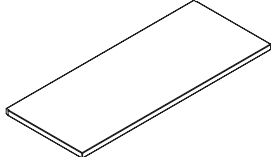

Piani  
Shelves

4.34

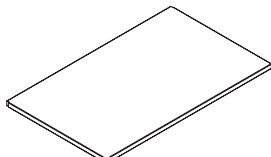
Piano in legno a sbalzo  
Overhanging wooden shelf

	 x	 y	 z	codice code	note notes	finitura finish	colori colours					
  	mensola bracket y=20				50	30	2,5	17.475			T	
					75	30	2,5	17.471			•	7035
					100	30	2,5	17.467			•	ACE
											•	BIA
											•	FAG
											•	MTZ
											•	PAN
											•	A439
											•	ANT
												K101
												3813
												2293
											990XA	
											990XM	
											A838	
											999XA	
											995XM	
											989XR	
											994XS	
											997XS	
											983XR	
											984XA	
											BLACK	
											GREEN	
											BEIGE	
											WHITE	
  	mensola bracket y=45				50	50	2,5	17.623				
					75	50	2,5	17.622				
					100	50	2,5	17.621				

Mensola: 5.5  
Bracket: 5.5

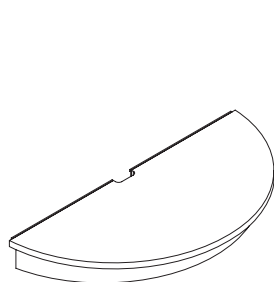

## 4.35

**Piano base di testata in legno con bordo in ABS**  
*Curved wooden shelf for front base unit*

	x	y	z	codice code	note notes	finitura finish	colori colours	colori colours
piantana upright y=7,2	87,2	40	10	17.594	Base h 10	T		
	107,2	50	10	17.595	Base h 10		7035	A838
							ACE	999XA
							BIA	995XM
							FAG	989XR
							MTZ	994XS
							PAN	997XS
piantana upright y=7,2	87,2	40	13	17.879	Base h 17		A439	983XR
	107,2	50	13	17.878	Base h 17		ANT	984XA
							K101	BLACK
							3813	GREEN
							2293	BEIGE
							990XA	WHITE
piantana upright y=9	89	40	13	17.880	Base h 17		990XM	
	109	50	13	17.881	Base h 17			

**Da usare esclusivamente con basi testa inclinata: 2.3**

*To be used only with sloped head bases: 2.3*

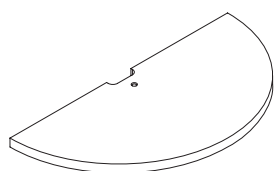

## 4.36

**Piano di testata sospeso in legno con bordo in ABS**  
*Curved wooden shelf hanging on front*

	x	y	z	codice code	note notes	finitura finish	colori colours	colori colours
piantana upright y=7,2	77,2	35	2,5	17.592	Mensola a sbalzo	T		
	87,2	40	2,5	17.593	Mensola a sbalzo		7035	A838
							ACE	999XA
							BIA	995XM
							FAG	989XR
							MTZ	994XS
							PAN	997XS
piantana upright y=7,2	77,2	35	2,5	17.882	Mensola testa Inclinata		A439	983XR
	87,2	40	2,5	17.884	Mensola testa Inclinata		ANT	984XA
							K101	BLACK
							3813	GREEN
							2293	BEIGE
							990XA	WHITE
piantana upright y=9	79	35	3	17.885	Mensola testa Inclinata		990XM	
	89	40	3	17.883	Mensola testa Inclinata			

**Da usare esclusivamente con piano a sbalzo: 4.34**

*To be used only with overhanging shelf: 4.34*

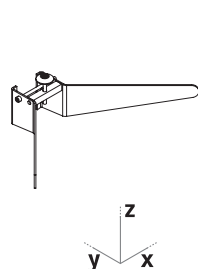
**Mensola a V per piano di testata**  
*Bracket for wooden shelf hanging on front*

	x	y	z	codice code	finitura e colore finish & colour	note notes
piantana upright y=7,2	--	--	--	16.-17	C	
piantana upright y=9	--	--	--	16.385	C	

# Accessori per piani a liste : divisori, frontali e greche

## *Accessories for plank: dividers, fronts and grids*

Accessori per piani a liste  
*Accessories for plank shelves*

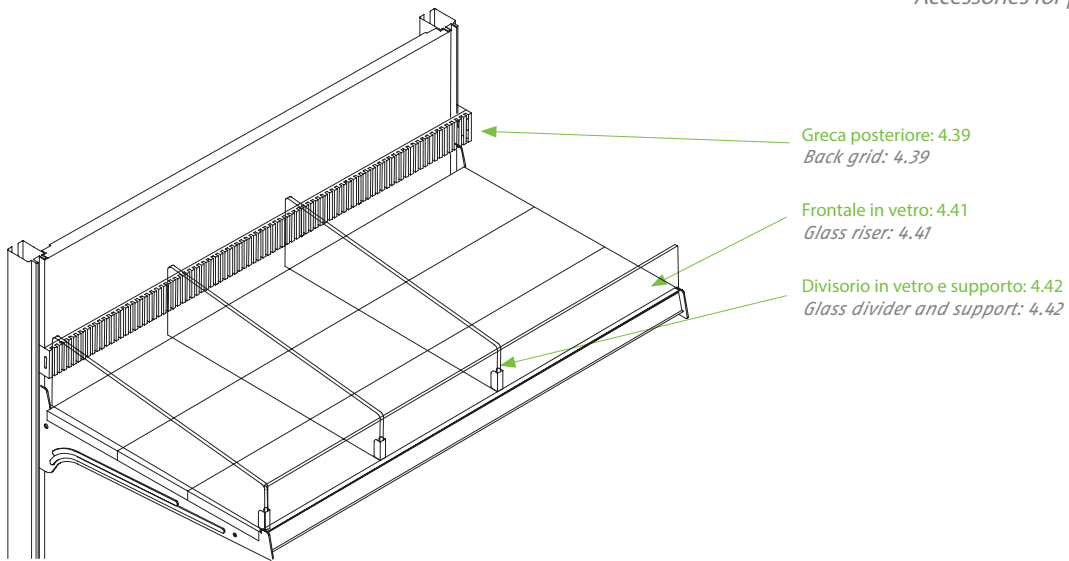

Piano dritto  
*Straight shelf*

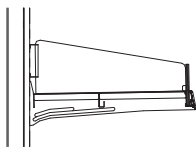

Piano inclinato  
*Angled shelf*

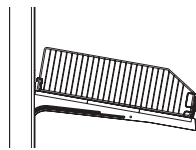

Greca posteriore: 4.40  
*Back grid: 4.40*

Frontale in filo: 4.37  
*Glass riser: 4.37*

Divisorio in filo: 4.38  
*Glass divider: 4.378*

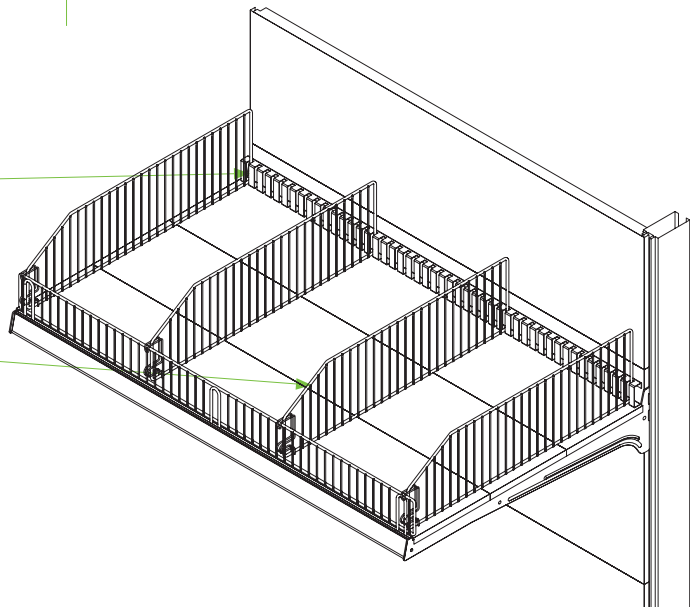



# Accessori per piani interi : divisori e frontali

## *Accessories for one piece shelf: dividers and fronts*

### Accessori per piani interi

*Accessories for one piece shelves*

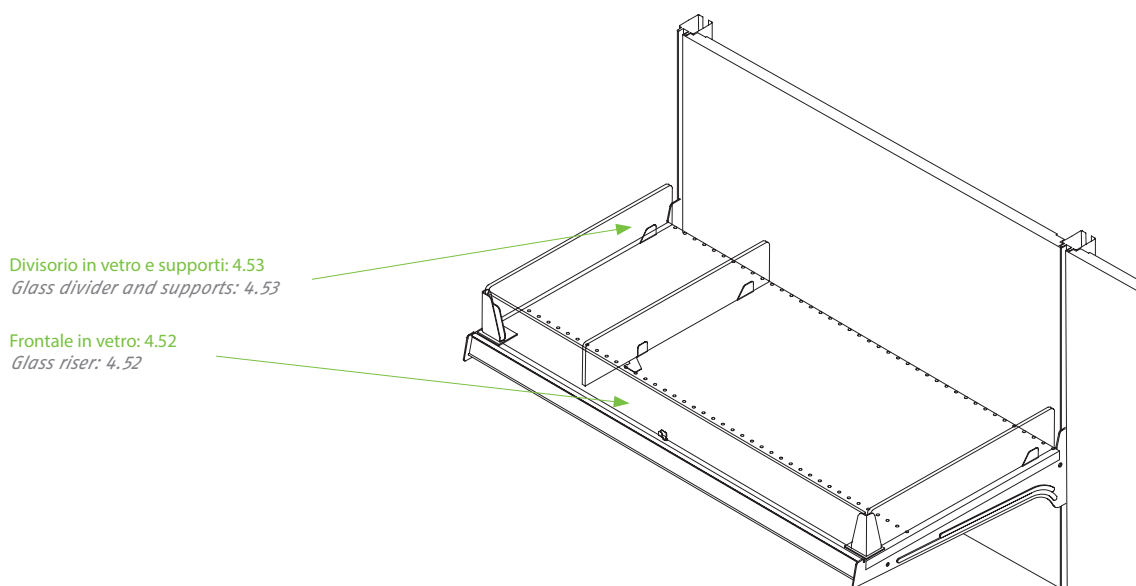
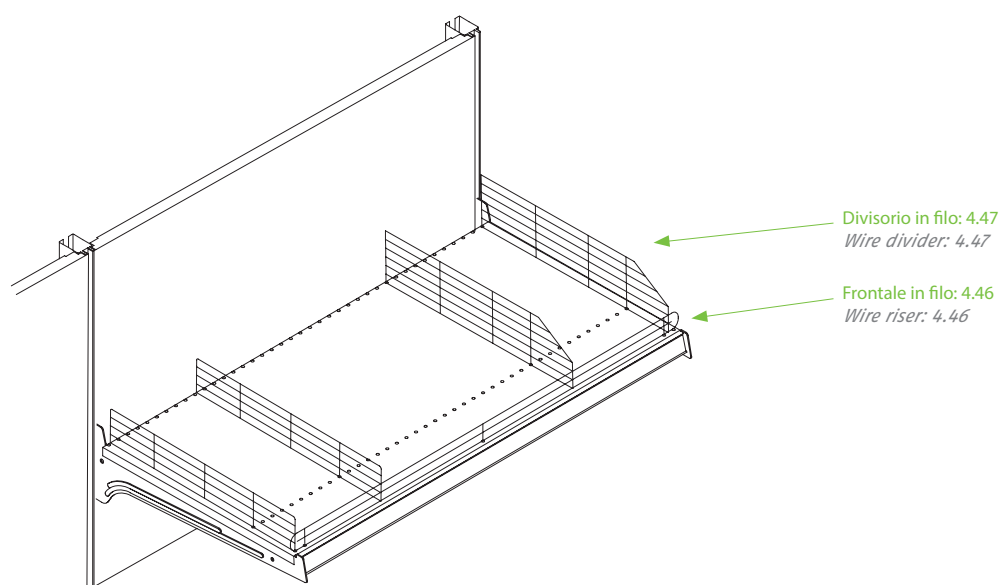

# Accessori per piani in filo e piani ExtraSlim: divisori e frontali

## *Accessories for wire and ExtraSlim shelf: dividers and fronts*

### Accessori per piani in filo *Accessories for wire shelf*

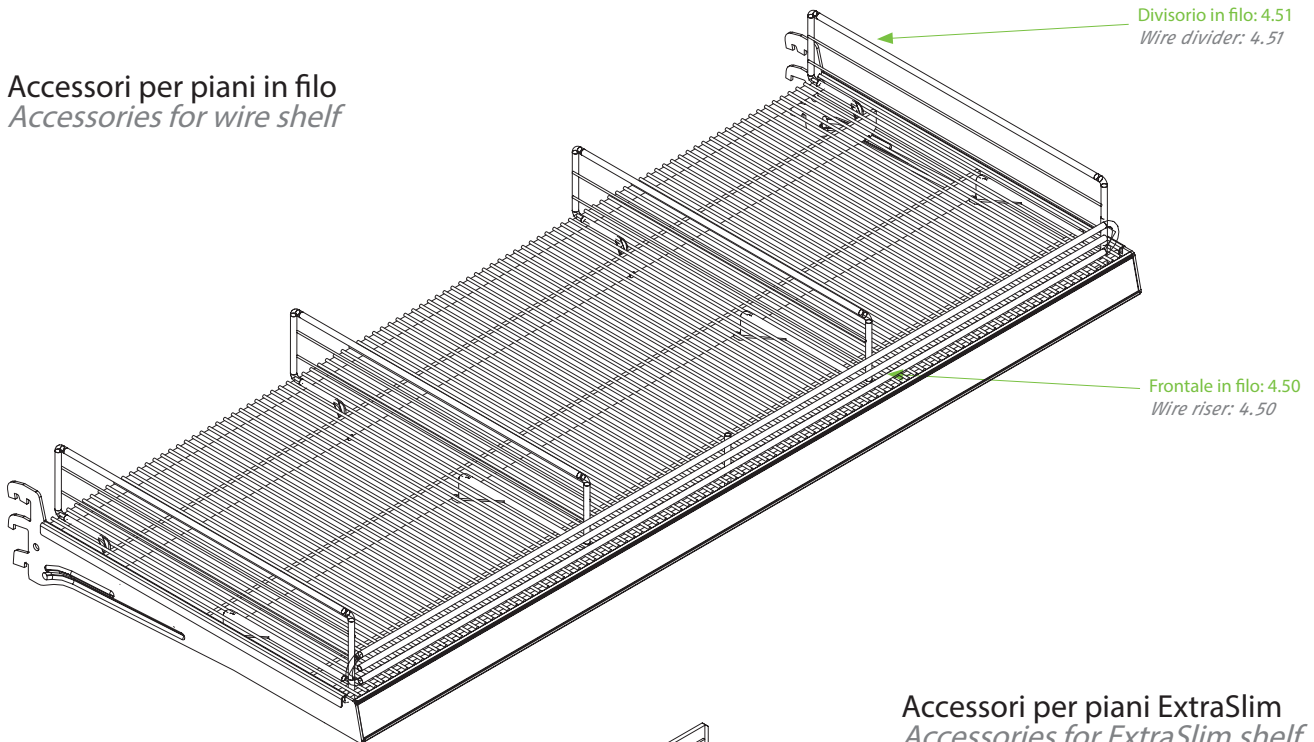

### Accessori per piani ExtraSlim *Accessories for ExtraSlim shelf*

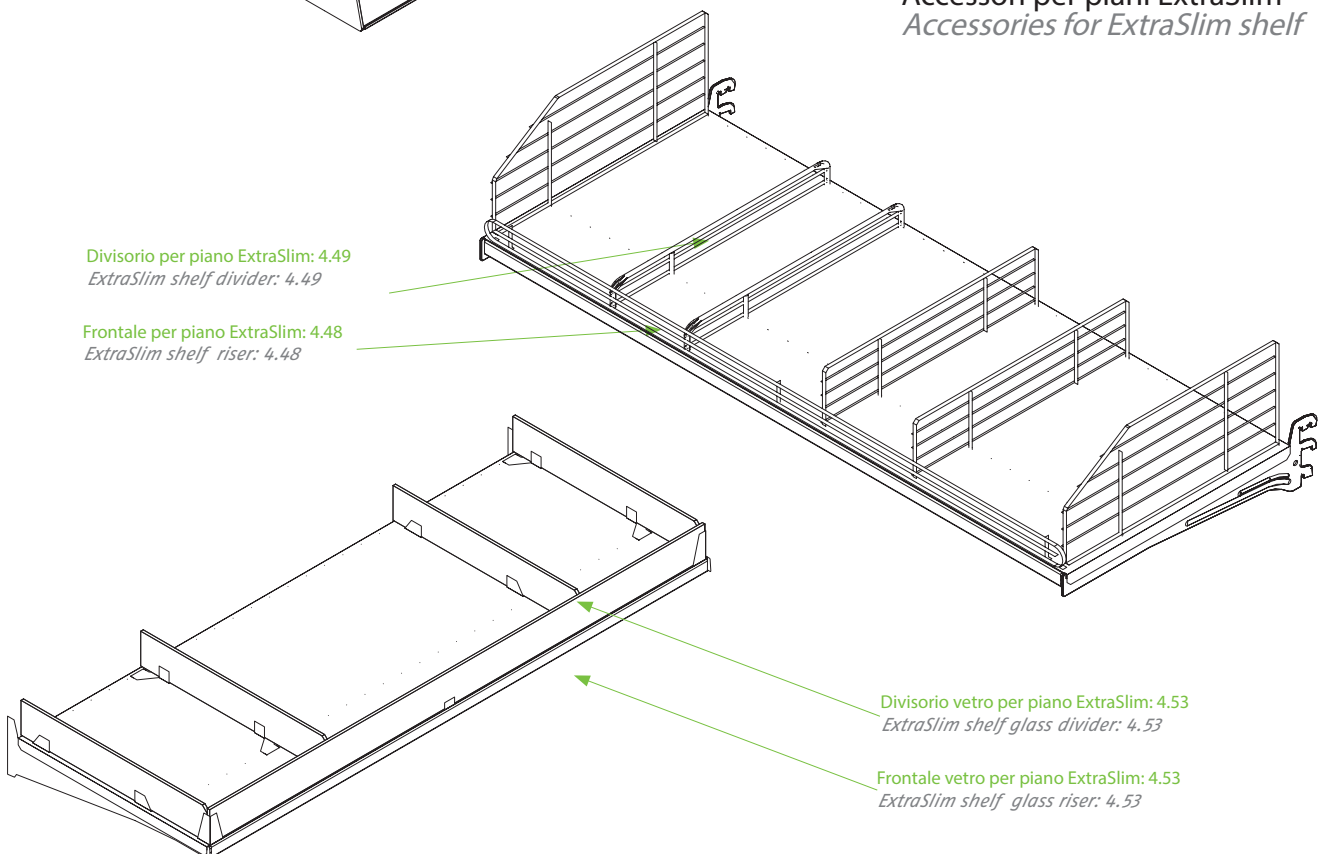



Accessori per Piani  
Shelving Accessories

4.37

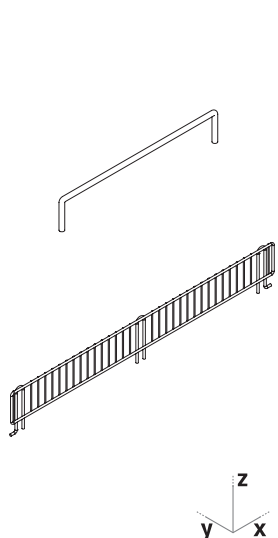
Frontale in filo per piani a liste  
Wire front riser for plank shelves







				codice code	finitura e colore finish & colour	note notes
	27	--	6	19.-52	C	
	50	--	9	19.-03	C	
	66,5	--	9	19.243	C	
	75	--	9	19.-02	C	
	100	--	9	19.-01	C	
	133	--	9	19.-04	C	

Accessori per Piani  
Shelving Accessories

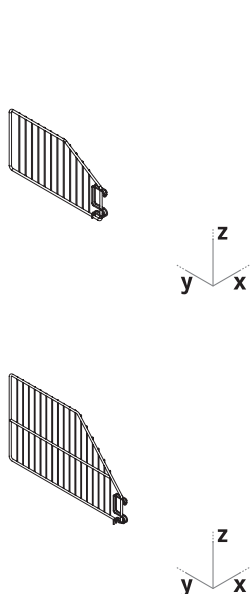
4.38

Divisori in filo per piani a liste  
Wire dividers for plank shelves



				codice code	finitura e colore finish & colour	note notes
	--	25	16	19.-05	C	
	--	30	16	19.-06	C	
	--	35	16	19.-07	C	
	--	40	16	19.-08	C	
	--	50	16	19.-09	C	
	--	60	16	19.-10	C	
	--	40	25	19.-11	C	
	--	50	25	19.-12	C	
	--	60	25	19.-13	C	
	--	70	25	19.-14	C	
	--	80	25	19.-58	C	

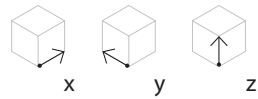
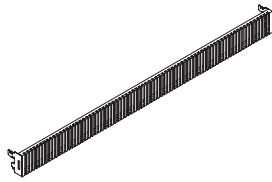

	x	y	z	codice code	note notes
	50	--	7	18.-27	
	66,5	--	7	18.173	
	75	--	7	18.-26	
	100	--	7	18.-25	
	133	--	7	18.-28	

finitura finish	colori colours
P	
	2004
	6018
	6027
•	7035
	AMA
	ANT
	AZZ
	1001
•	BIA
	BLU
	GIA
	MAR
•	MTZ
•	PAN
	RO3
	BIMCL
	NRMCL
	OXI

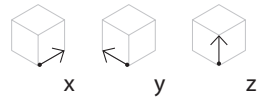
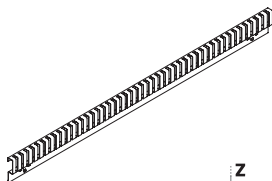

	x	y	z	codice code	note notes
	50	--	7	18.257	
	66,5	--	7	18.260	
	75	--	7	18.256	
	100	--	7	18.255	
	133	--	7	18.258	

finitura finish	colori colours
P	
	2004
	6018
	6027
•	7035
	AMA
	ANT
	AZZ
	1001
•	BIA
	BLU
	GIA
	MAR
•	MTZ
•	PAN
	RO3
	BIMCL
	NRMCL
	OXI

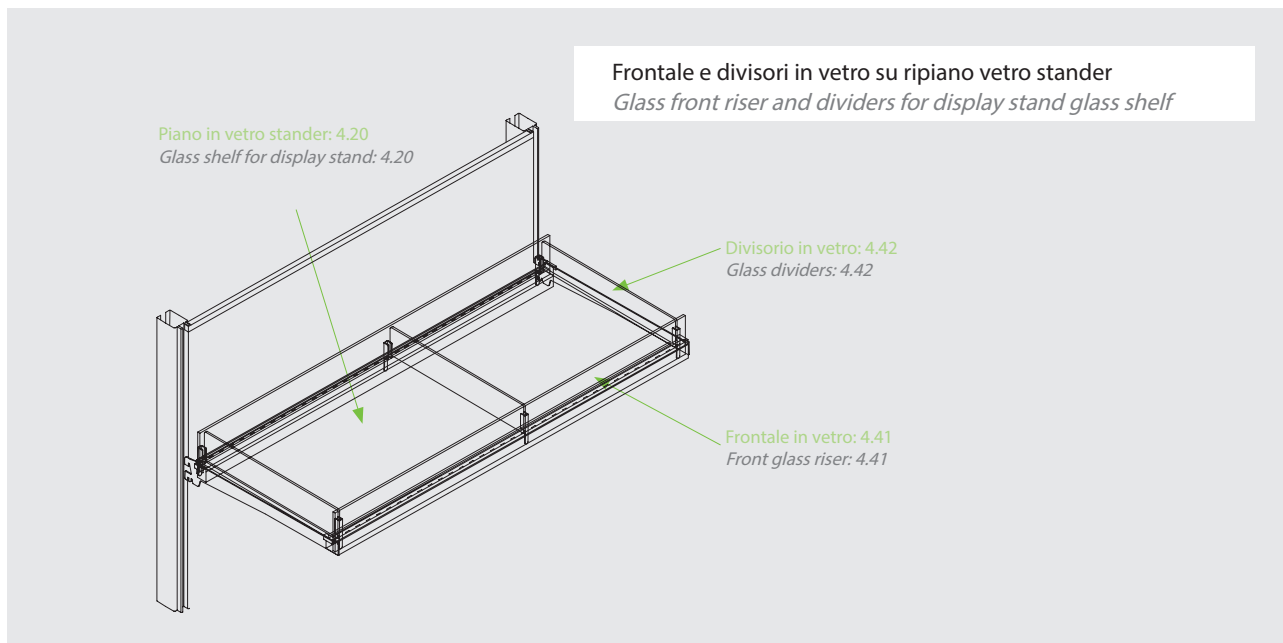

Accessori per Piani  
*Shelving Accessories*

4.41

Frontale temprato in vetro per piani a liste, piani in legno  
*Front glass riser for plank shelf*

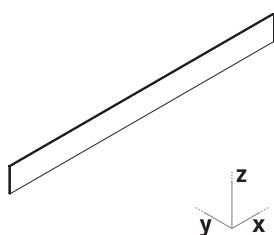

x	y	z	codice code	finitura e colore finish & colour	note notes
50	0,5	9	19.-17	NT	
66,5	0,5	9	19.162	NT	
75	0,5	9	19.-16	NT	
100	0,5	9	19.-15	NT	
133	0,5	9	19.-45	NT	

Accessori per Piani  
*Shelving Accessories*

4.42

Divisori in vetro temprato trapezoidale per piani a liste e piani in legno  
*Tempered glass dividers for plank shelf*

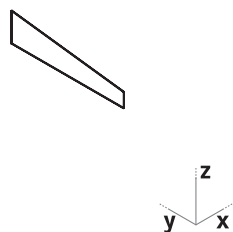

x	y	z	codice code	finitura e colore finish & colour	note notes
0,5	25	12/6	19.-18	NT	
0,5	30	12/6	19.-19	NT	
0,5	35	12/6	19.-20	NT	
0,5	40	12/6	19.-21	NT	
0,5	50	12/6	19.-22	NT	
0,5	60	12/6	19.-23	NT	

Supporto anteriore per divisorio in vetro  
*Front divider for plank or wooden shelf*

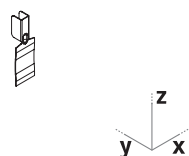

x	y	z	codice code	finitura e colore finish & colour	note notes
--	--	4,5	34.-12	C	

4.43

Greca anteriore per piani a liste e piani in legno  
Front grid for plank or wooden shelves

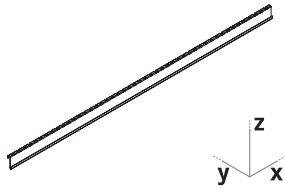

				codice code	note notes
	x	y	z		
	50	--	--	18.248	
	66,5	--	--	18.261	
	75	--	--	18.247	
	100	--	--	18.246	
	133	--	--	18.259	

finitura finish	colori colours
P	
	2004
	6018
	6027
•	7035
	AMA
	ANT
	AZZ
	1001
•	BIA
	BLU
	GIA
	MAR
•	MTZ
•	PAN
	RO3
	BIMCL
	NRMCL
	OXI

4.44

Divisori in plexiglass per piani a liste e piani in legno  
Plexiglas dividers for plank or wooden shelf

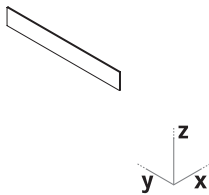

				codice code	finitura e colore finish & colour	note notes
	x	y	z			
	0,5	25	8	19.205	N	
	0,5	30	8	19.206	N	
	0,5	35	8	19.207	N	
	0,5	40	8	19.208	N	
	0,5	50	8	19.209	N	
	0,5	60	8	19.210	N	

4.45

Divisorio in vetro temperato per piani stander  
Tempered glass dividers for stander shelves

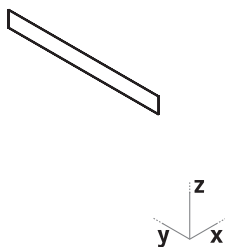

				codice code	finitura e colore finish & colour	note notes
	x	y	z			
	--	23,4	6	19.217	NT	
	--	30	6	19.200	NT	
	--	33	6	19.219	NT	
	--	40	6	19.201	NT	

Supporto ant./post. divisorio vetro su traverso cavettato  
Front/back support for glass divider on crosspiece

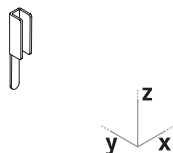





				codice code	finitura e colore finish & colour	note notes
	x	y	z			
	0,7	0,8	4,5	34.213	C	

Accessori per Piani  
Shelving Accessories

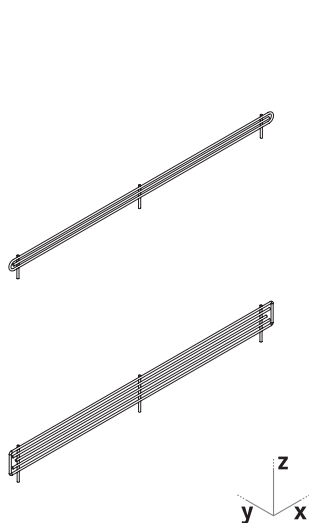
4.46

Frontalino in filo per piani interi  
Wire front riser for one piece shelf







	 x	 y	 z	codice code	finitura e colore finish & colour	note notes
	66,5	--	3,5	19.139	C	
	100	--	3,5	19.140	C	
	133	--	3,5	19.141	C	
	66,5	--	8	19.136	C	
	100	--	8	19.137	C	
	133	--	8	19.138	C	

Accessori per Piani  
Shelving Accessories

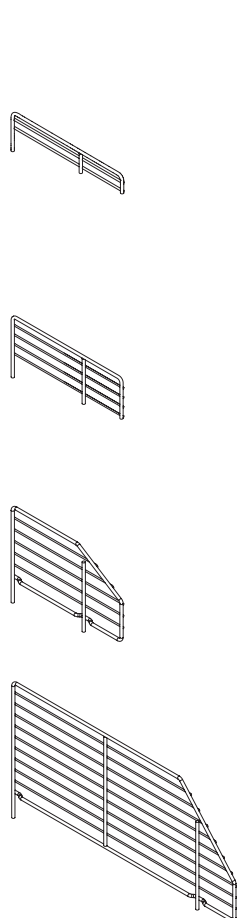
4.47

Divisorio in filo per piani interi  
Wire divider for one piece shelf







	 x	 y	 z	codice code	finitura e colore finish & colour	note notes
	--	30	3,5	19.294	C	
	--	40	3,5	19.281	C	
	--	50	3,5	19.282	C	
	--	60	3,5	19.295	C	
	--	30	8	19.146	C	
	--	40	8	19.145	C	
	--	50	8	19.134	C	
	--	60	8	19.135	C	
	--	30	16	19.149	C	
	--	40	16	19.144	C	
	--	50	16	19.142	C	
	--	60	16	19.143	C	
	--	40	25	19.152	C	
	--	50	25	19.153	C	
	--	60	25	19.154	C	
	--	70	25	19.155	C	

Accessori per Piani  
Shelving Accessories

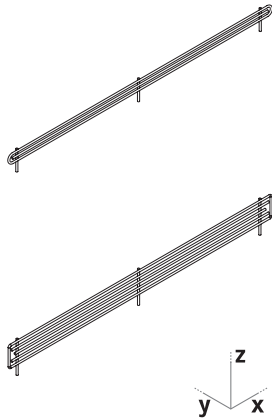
4.48

Frontalino in filo per piani interi ExtraSlim  
Wire front riser for ExtraSlim one piece shelf







				codice code	finitura e colore finish & colour	note notes
	66,5	--	3,5	19.319	C	
	100	--	3,5	19.311	C	
	133	--	3,5	19.310	C	
	66,5	--	8	19.320	C	
	100	--	8	19.315	C	
	133	--	8	19.316	C	

Accessori per Piani  
Shelving Accessories

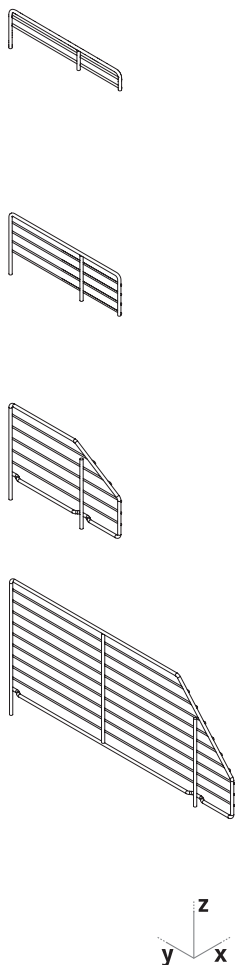
4.49

Divisorio in filo per piani interi ExtraSlim  
Wire divider for ExtraSlim one piece shelf



				codice code	finitura e colore finish & colour	note notes
	--	30	3,5	19.294	C	
	--	40	3,5	19.281	C	
	--	50	3,5	19.282	C	
	--	60	3,5	19.295	C	
	--	30	8	19.146	C	
	--	40	8	19.145	C	
	--	50	8	19.134	C	
	--	60	8	19.135	C	
	--	30	16	19.149	C	
	--	40	16	19.144	C	
	--	50	16	19.142	C	
	--	60	16	19.143	C	
	--	40	25	19.152	C	
	--	50	25	19.153	C	
	--	60	25	19.154	C	
	--	70	25	19.155	C	



Accessori per Piani  
Shelving Accessories

4.50

Frontale per piani in filo  
Front riser for wire shelf

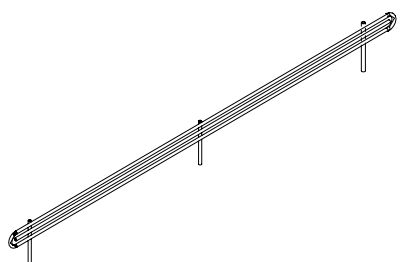

x	y	z	codice code	finitura e colore finish & colour	note notes
66,5	--	3,5	19.299	C	
100	--	3,5	19.288	C	
133	--	3,5	19.292	C	
66,5	--	8	19.302	C	
100	--	8	19.300	C	
133	--	8	19.301	C	

Accessori per Piani  
Shelving Accessories

4.51

Divisori per Piani in filo  
Divider for wire shelf

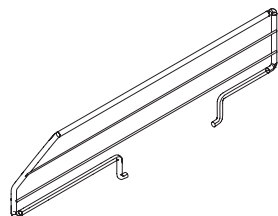
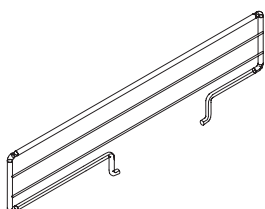
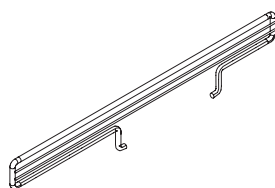

x	y	z	codice code	finitura e colore finish & colour	note notes
--	30	3,5	19.297	C	
--	40	3,5	19.284	C	
--	50	3,5	19.285	C	
--	30	8	19.330	C	
--	40	8	19.324	C	
--	50	8	19.322	C	
--	30	8/3,5	19.298	C	
--	40	8/3,5	19.286	C	
--	50	8/3,5	19.287	C	

Accessori per Piani  
Shelving Accessories

4.52

Frontalino in vetro temprato per piani interi  
Tempered glass riser for one piece shelves

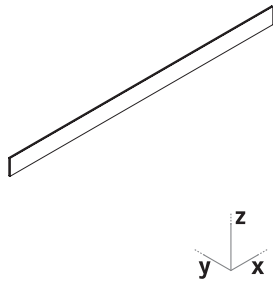

				codice code	finitura e colore finish & colour	note notes
50	--	--	6	19.244	NT	
66,5	--	--	6	19.158	NT	
75	--	--	6	19.245	NT	
100	--	--	6	19.156	NT	
133	--	--	6	19.157	NT	

Accessori per Piani  
Shelving Accessories

4.53

Divisorio in vetro temprato per piani interi  
Tempered glass divider for one piece shelves

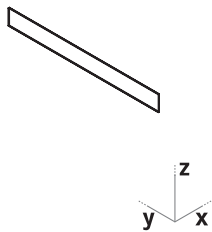

				codice code	finitura e colore finish & colour	note notes
--	50	--	6	19.202	NT	
--	60	--	6	19.203	NT	

Supporto angolare dx/sx per frontalino e divisorio  
Lh/rh corner support for glass divider

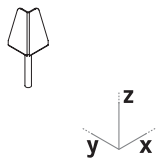

				codice code	finitura e colore finish & colour	note notes
--	--	--	5	34.223	C	

Supporto intermedio frontalino  
Front support for glass riser

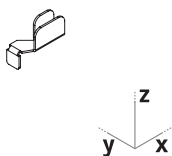

				codice code	finitura e colore finish & colour	note notes
--	2	--	--	34.224	C	

Supporto divisorio  
Support for glass divider

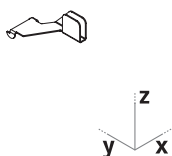

				codice code	finitura e colore finish & colour	note notes
dx rh	--	--	--	34.225	C	
sx lh	--	--	--	34.269	C	

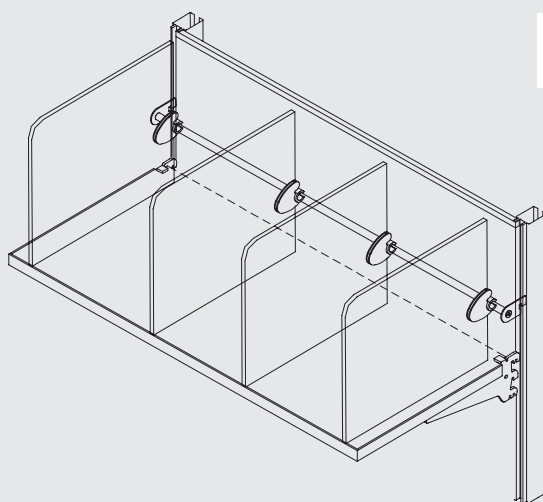

Barra reggi morsetti su piano in legno  
Pigeonholes with clamps on wooden shelf

Accessori per Piani  
Shelving Accessories

4.54

Barra reggi morsetti con mensole per piani in legno e piani in vetro  
Tubular crosspiece with shelves for pigeonholes with clamps

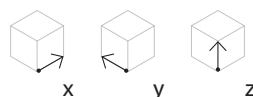
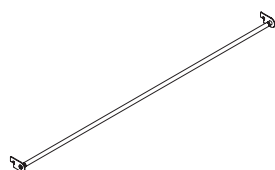

x	y	z	codice code	finitura e colore finish & colour	note notes
50	--	--	34.-27	C	
75	--	--	34.-26	C	
100	--	--	34.-25	C	

Divisorio in vetro temperato per barra morsetti  
Clamp glass divider

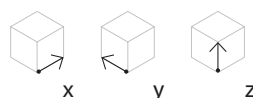
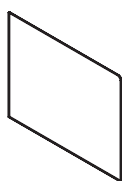

x	y	z	codice code	finitura e colore finish & colour	note notes
0,5	25,3	14	19.211	N	
0,5	25,3	28,6	19.-46	N	
				N	
0,5	30,3	14	19.212	N	
0,5	30,3	28,6	19.-47	N	
0,5	35,3	14	19.213	N	
0,5	35,3	28,6	19.-48	N	

Morsetto in PVC per il sostegno dei divisorii  
PVC support for clamp glass divider



x	y	z	codice code	finitura e colore finish & colour	note notes
--	--	--	34.-29	T TRA	

Composizione con elemento di collegamento piani  
Setting with filler plate for opposite gondola shelves

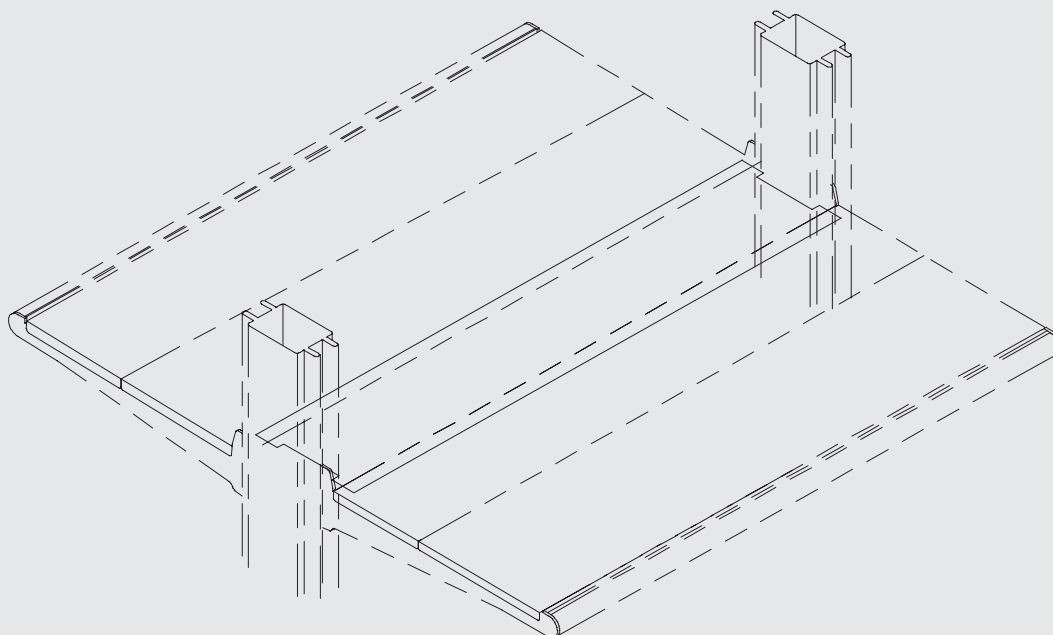



Accessori per Piani  
Shelving Accessories

4.55

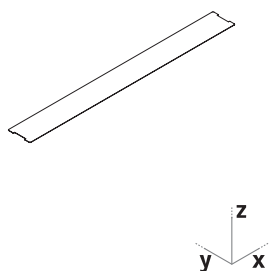
Collegamento piani a liste e interi in metallo  
Filler plate for opposite gondola shelves without back panels



				codice code	note notes
	x	y	z		
piantana upright y=7,2	50	10,2	--	17.461	
	75	10,2	--	17.460	
	100	10,2	--	17.459	
piantana upright y=9	50	12,2	--	17.465	
	75	12,2	--	17.464	
	100	12,2	--	17.463	

finitura finish	colori colours
P	V
	2004
	6018
	6027
•	7035
	AMA
•	ANT
	AZZ
	1001
•	BIA
	BLU
	GIA
	MAR
	• MTZ
•	PAN
	RO3
	BIMCL
	NRMCL
	• OXI

**note**  
*notes*

**note**  
*notes*

# Mensole *Brackets*

# 5

Mensole slim, mensole nervate, mensole a più posizioni, mensole stander, mensole per piani a sbalzo, mensole speciali, mensole minirack, mensole sponda, mensole a L, mensole cielino.

*Slim brackets, ribbed brackets, several position brackets, display stand brackets, brackets for overhanging shelves, particular brackets, minirack brackets, retainer brackets, L shaped brackets, brackets for canopy fronts.*





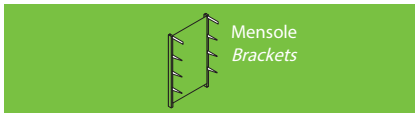

5.1

Mensola inclinabile tipo slim  
Slim brackets

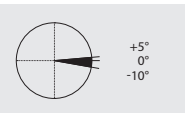

				codice code	note notes	
	testa inclinata <i>sloped head</i>	--	15	--	16.290	
		--	20	--	16.291	
		--	25	--	16.237	
		--	30	--	16.238	
		--	35	--	16.239	
		--	40	--	16.240	
		--	50	--	16.241	
	testa tonda <i>round head</i>	--	15	--	16.292	
		--	20	--	16.293	
		--	25	--	16.169	
		--	30	--	16.140	
		--	35	--	16.145	
		--	40	--	16.141	
		--	50	--	16.142	

finitura finish	colori colours
<b>C</b>	<b>V</b>
	2004
	6018
	6027
	• 7035
	AMA
	• ANT
	AZZ
	1001
	• BIA
	BLU
	GIA
	MAR
	• MTZ
	• PAN
	RO3
	BIMCL
	NRMCL
	• OXI
	---

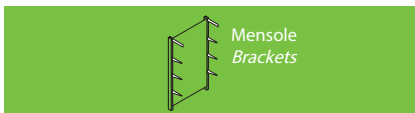

5.2

Mensola inclinabile tipo nervata  
Ribbed bracket

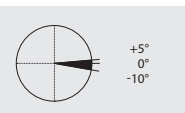

				codice code	note notes	
	testa inclinata <i>sloped head</i>	--	40	--	16.152	
		--	50	--	16.182	
		--	60	--	16.183	
		--	70	--	16.195	
	testa tonda <i>round head</i>	--	80	--	16.196	
		--	60	--	16.143	
		--	70	--	16.144	
		--	80	--	16.197	

finitura finish	colori colours
<b>C</b>	<b>V</b>
	2004
	6018
	6027
	• 7035
	AMA
	• ANT
	AZZ
	1001
	• BIA
	BLU
	GIA
	MAR
	• MTZ
	• PAN
	RO3
	BIMCL
	NRMCL
	• OXI
	---

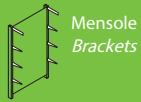

Mensole  
Brackets

5.3

Mensola inclinabile Extra Slim  
Extra Slim bracket

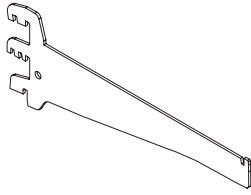

	x	y	z	codice code	note notes
testa diritta straight head	--	25	--	16.426	
	--	30	--	16.430	



Per piani mini-ExtraSlim: 4.10  
For mini-ExtraSlim shelves: 4.10

finitura finish	colori colours
<b>C</b>	<b>V</b>
	2004
	6018
	6027
	• 7035
	AMA
	• ANT
	AZZ
	1001
	• BIA
	BLU
	GIA
	MAR
	• MTZ
	• PAN
	RO3
	BIMCL
	NRMCL
	• OXI
•	---

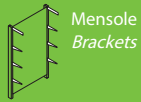

Mensole  
Brackets

5.4

Mensola inclinabile tipo nervata Extra Slim  
Extra Slim Ribbed bracket

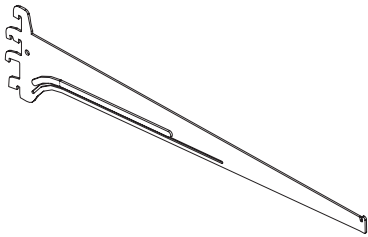
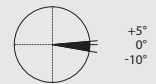

	x	y	z	codice code	note notes
testa diritta head	--	40	--	16.414	
	--	50	--	16.407	
	--	60	--	16.405	
	--	70	--	16.415	
	--	80	--	16.418	



Per piani ExtraSlim: 4.9  
For ExtraSlim shelves: 4.9

finitura finish	colori colours
<b>C</b>	<b>V</b>
	2004
	6018
	6027
	• 7035
	AMA
	• ANT
	AZZ
	1001
	• BIA
	BLU
	GIA
	MAR
	• MTZ
	• PAN
	RO3
	BIMCL
	NRMCL
	• OXI
•	---

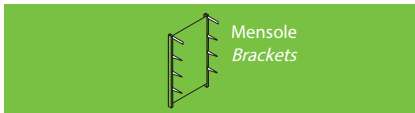

5.5

Mensola inclinabile a più posizioni  
Several positions brackets

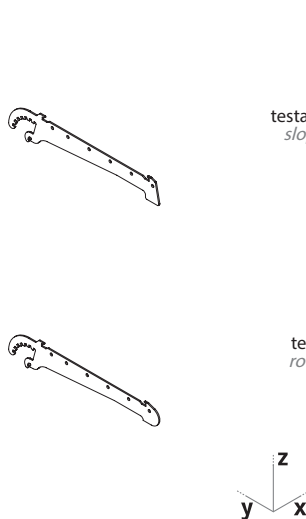
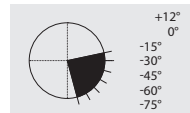

	x	y	z	codice code	note notes
testa inclinata sloped head	--	20	--	16.318	
	--	25	--	16.314	
	--	30	--	16.320	
	--	35	--	16.321	
testa tonda round head	--	20	--	16.341	
	--	25	--	16.315	
	--	30	--	16.342	
	--	35	--	16.343	

finitura finish	colori colours	colori colours
C	V	
•	---	MAR
	2004	• MTZ
	6018	• PAN
	6027	RO3
•	7035	BIMCL
	AMA	NRMCL
•	ANT	• OXI
	AZZ	
	1001	
•	BIA	
	BLU	
	GIA	

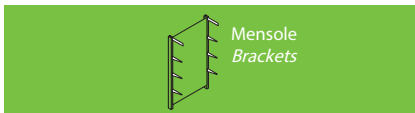

5.6

Mensola stander  
Display stand brackets

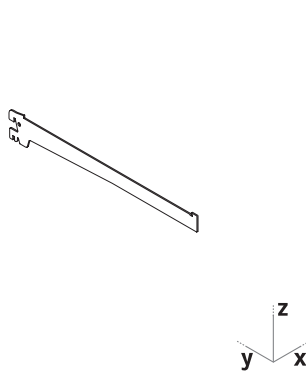
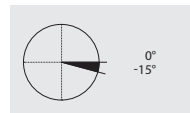

	x	y	z	codice code	note notes
	--	23,7	--	16.304	
	--	28,5	--	16.305	
	--	33,3	--	16.306	
	--	38,1	--	16.307	

finitura finish	colori colours	colori colours
C	V	
•	---	MAR
	2004	• MTZ
	6018	• PAN
	6027	RO3
•	7035	BIMCL
	AMA	NRMCL
•	ANT	OXI
	AZZ	
	1001	
•	BIA	
	BLU	
	GIA	

Piani in vetro stander:  
4.20  
Glass shelf for display stand: 4.20



5.7

Mensola inclinabile con piolino per piano in legno a sbalzo  
Bracket for overhanging wooden shelf

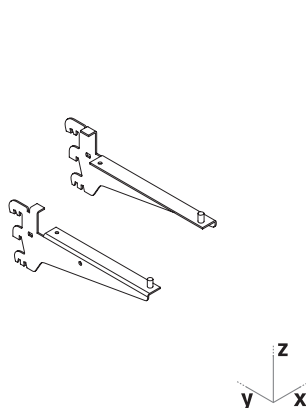
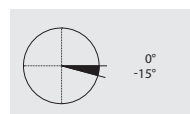

	x	y	z	codice code	note notes
dx rh	--	20	--	16.201	
sx lh	--	20	--	16.202	
dx rh	--	45	--	16.302	
sx lh	--	45	--	16.303	

finitura finish	colori colours	colori colours
C	V	
•	---	MAR
	2004	• MTZ
	6018	• PAN
	6027	RO3
•	7035	BIMCL
	AMA	NRMCL
•	ANT	• OXI
	AZZ	
	1001	
•	BIA	
	BLU	
	GIA	

Piani in legno a sbalzo: 4.34  
Overhanging wooden shelf: 4.34

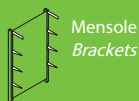

Mensole  
Brackets

5.8

Mensola per piano in vetro a sbalzo 8 mm  
Bracket for overhanging glass shelf 8 mm thick

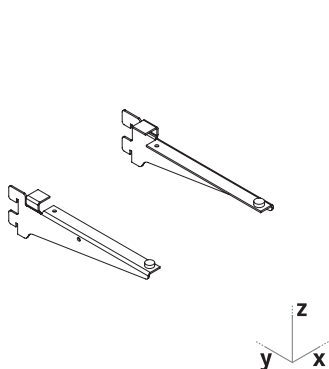

	x	y	z	codice code
dx rh	--	20	--	16.282
sx lh	--	20	--	16.283

note notes

finitura finish

colori colours

colori colours

colori colours	colori colours
• ---	MAR
• 2004	• MTZ
• 6018	• PAN
• 6027	RO3
• 7035	BIMCL
• AMA	NRMCL
• ANT	• OXI
• AZZ	
• 1001	
• BIA	
• BLU	
• GIA	

Piani in vetro a sbalzo: 4.26  
Overhanging glass shelf: 4.26

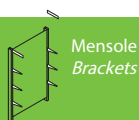

Mensole  
Brackets

5.9

Mensola "Light" per piano in vetro a sbalzo 8 mm  
"Light" bracket for overhanging glass shelf 8 mm thick

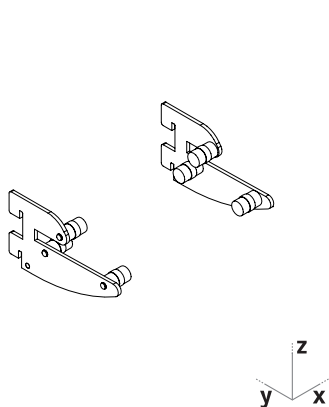

	x	y	z	codice code
dx rh	--	8	--	16.658
sx lh	--	8	--	16.657

note notes

finitura finish

colori colours

colori colours

colori colours	colori colours
• ---	MAR
• 2004	• MTZ
• 6018	• PAN
• 6027	RO3
• 7035	BIMCL
• AMA	NRMCL
• ANT	• OXI
• AZZ	
• 1001	
• BIA	
• BLU	
• GIA	

Piani in vetro a sbalzo:  
Overhanging glass she

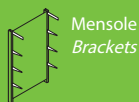

Mensole  
Brackets

5.10

Mensola per piano in vetro a sbalzo 10 mm  
Bracket for overhanging glass shelf 10 mm thick

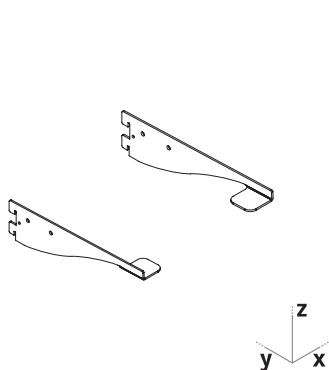

	x	y	z	codice code
dx rh	--	25	--	16.334
sx lh	--	25	--	16.335

note notes

finitura finish

colori colours

colori colours

colori colours	colori colours
• ---	MAR
• 2004	• MTZ
• 6018	• PAN
• 6027	RO3
• 7035	BIMCL
• AMA	NRMCL
• ANT	• OXI
• AZZ	
• 1001	
• BIA	
• BLU	
• GIA	

Piani in vetro a sbalzo: 4.28  
Overhanging glass shelf: 4.28

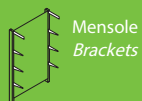

5.11

Mensola inclinabile porta depliant, videocassette e CD  
Bracket for leaflet shelf

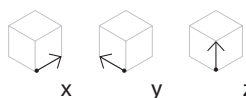
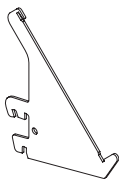

	x	y	z	codice code	note notes
	--	15	--	16.184	

Piani porta depliant: 4.2  
Leaflet shelf: 4.2



finitura finish	colori colours
V	
	2004
	6018
	6027
	• 7035
	AMA
	• ANT
	AZZ
	1001
	• BIA
	BLU
	GIA
	MAR
	• MTZ
	• PAN
	RO3
	BIMCL
	NRMCL
	• OXI

**Mensole Brackets** **5.12** **Mensola per piano espositivo superiore in vetro**  
*Flying bracket for upper display shelf*

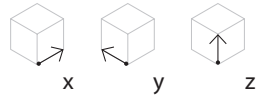
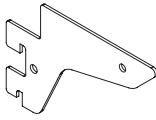

codice  
code

note  
notes

x	y	z	codice code
--	10	--	16.275

finitura  
finish

colori  
colours

finitura finish	colori colours
V	2004
	6018
	6027
	• 7035
	AMA
	• ANT
	AZZ
	1001
	• BIA
	BLU
	GIA
	MAR
	• MTZ
	• PAN
	RO3
	BIMCL
	NRMCL
	• OXI

Piano espositivo  
in vetro: 4.25  
Glass display shelf: 4.25

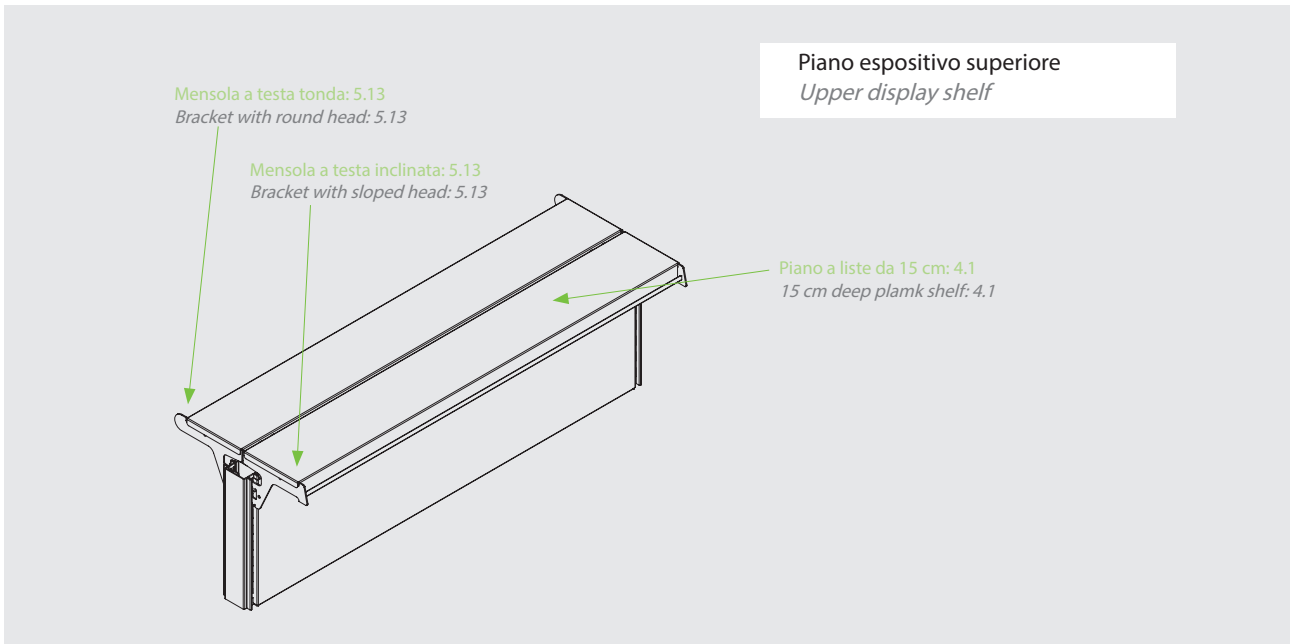

**Mensole Brackets** **5.13** **Mensola per piano espositivo**  
*Bracket for display shelf*

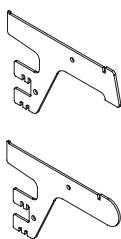

codice  
code

note  
notes

finitura  
finish

colori  
colours

colori  
colours

	x	y	z	codice code
testa inclinata <i>sloped head</i>	--	15	--	16.261
testa tonda <i>round head</i>	--	15	--	16.259

C V

•	---
	2004
	6018
	6027
	• 7035
	AMA
	• ANT
	AZZ
	1001
	• BIA
	BLU
	GIA

	MAR
•	MTZ
•	PAN
	RO3
	BIMCL
	NRMCL
•	OXI

Da usare con il piano a  
liste da 15: 4.1  
To be used with 15 cm  
deep plank shelf: 4.1



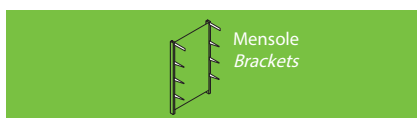
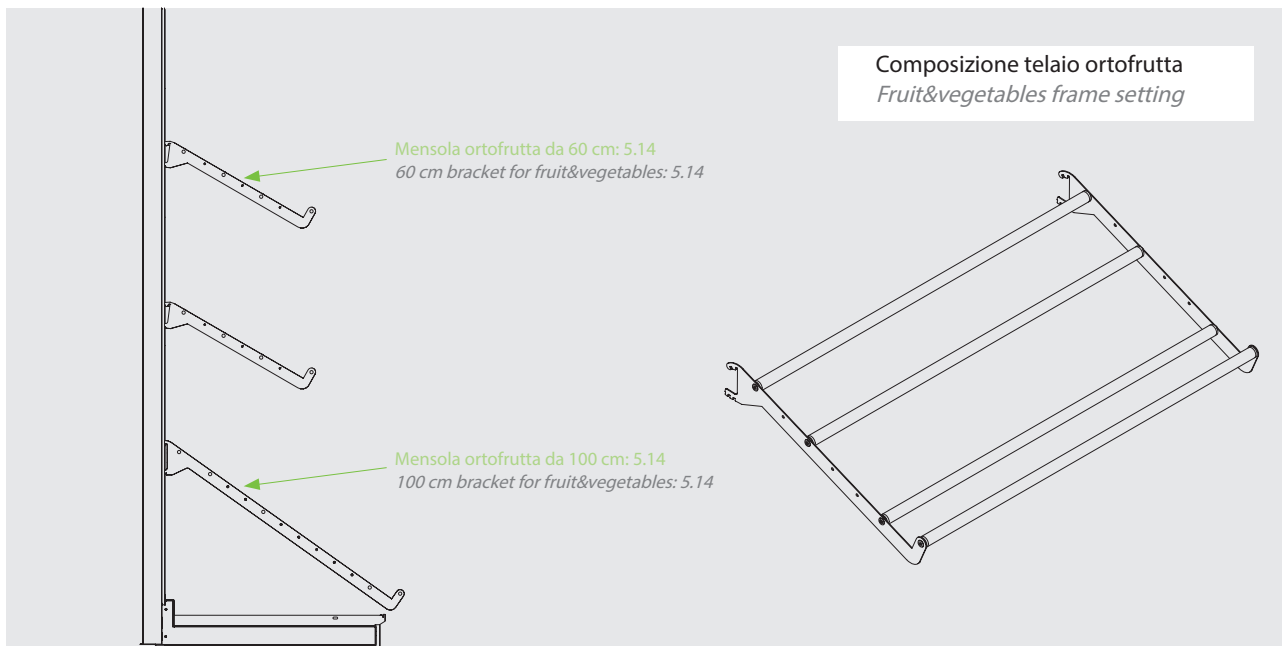

5.14

Mensola telaio ortofrutta  
Bracket for fruit&vegetables frame

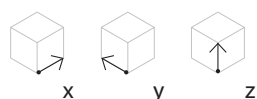
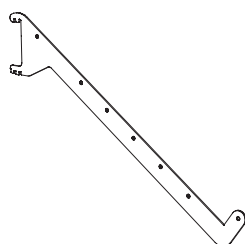
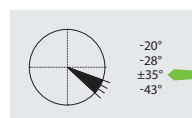

x	y	z	codice code	note notes
--	60	--	16.436	Nr. 4 traversi
--	100	--	16.431	Nr. 6 traversi

finitura finish	colori colours
V	2004
	6018
	6027
	• 7035
	AMA
	ANT
	AZZ
	1001
	• BIA
	BLU
	GIA
	MAR
	MTZ
	• PAN
	RO3
	BIMCL
	NRMCL
	• OXI

Traverso tubolare per telaio ortofrutta  
Tubular crosspiece for fruit&vegetables frame

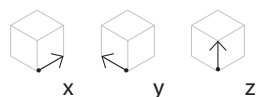
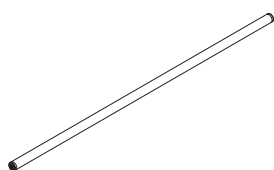

x	y	z	codice code	finitura e colore finish & colour	note notes
50	--	--	34.273	V 6018	
66,5	--	--	34.399	V 6018	
75	--	--	34.272	V 6018	
100	--	--	34.271	V 6018	

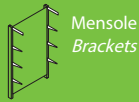

Mensole  
Brackets

5.15

Mensola portapiano Minirack  
*Minirack bracket*

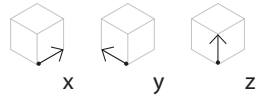
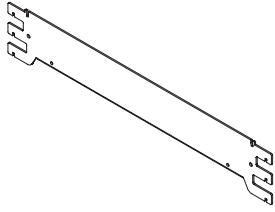

	x	y	z	codice code	note notes
--	50	--	16.185		
--	60	--	16.186		
--	70	--	16.187		
--	80	--	16.188		

finitura finish	colori colours
V	
	2004
	6018
	6027
	• 7035
	AMA
	ANT
	AZZ
	1001
	• BIA
	BLU
	GIA
	MAR
	MTZ
	• PAN
	RO3
	BIMCL
	NRMCL
	• OXI

Fermo per mensola Minirack con vite e dado  
*Safety bolt for Minirack bracket*

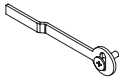

	x	y	z	codice code	finitura e colore finish & colour	note notes
--	--	--	16.189	C		

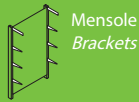

Mensole  
Brackets

5.16

Mensola Minirack per piano aggiuntivo  
*Minirack bracket for additional shelf*

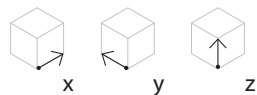
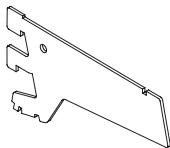

	x	y	z	codice code	note notes
--	20	--	16.236		

Piano Minirack  
aggiuntivo: 4.8  
*Minirack additional  
shelf: 4.8*

finitura finish	colori colours
V	
	2004
	6018
	6027
	• 7035
	AMA
	ANT
	AZZ
	1001
	• BIA
	BLU
	GIA
	MAR
	MTZ
	• PAN
	RO3
	BIMCL
	NRMCL
	• OXI

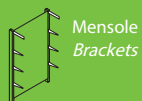

Mensole  
Brackets

5.17

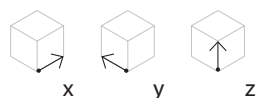
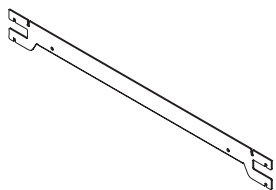
Mensola portapiano Minirack ExtraSlim  
ExtraSlim Minirack bracket

x	y	z	codice code	note notes
--	50	--	16.410	
--	60	--	16.411	
--	70	--	16.412	
--	80	--	16.413	

finitura finish	colori colours
V	
	2004
	6018
	6027
	• 7035
	AMA
	ANT
	AZZ
	1001
	• BIA
	BLU
	GIA
	MAR
	MTZ
	• PAN
	RO3
	BIMCL
	NRMCL
	• OXI

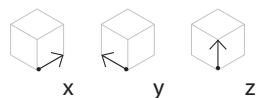
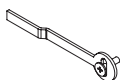
Fermo per mensola Minirack con vite e dado  
Safety bolt for Minirack bracket

x	y	z	codice code	finitura e colore finish & colour	note notes
--	--	--	16.189	C	

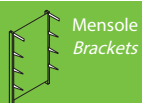
Mensole  
Brackets

5.18

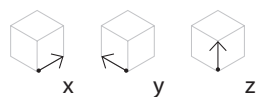
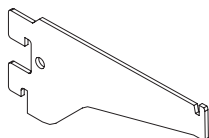
Mensola Minirack ExtraSlim per piano aggiuntivo  
ExtraSlim Minirack bracket for additional shelf

x	y	z	codice code	note notes
--	20	--	16.408	

Piano Minirack  
aggiuntivo: 4.12  
Minirack additional  
shelf: 4.12

finitura finish	colori colours
V	
	2004
	6018
	6027
	• 7035
	AMA
	ANT
	AZZ
	1001
	• BIA
	BLU
	GIA
	MAR
	MTZ
	• PAN
	RO3
	BIMCL
	NRMCL
	• OXI

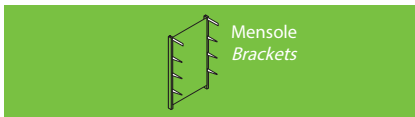
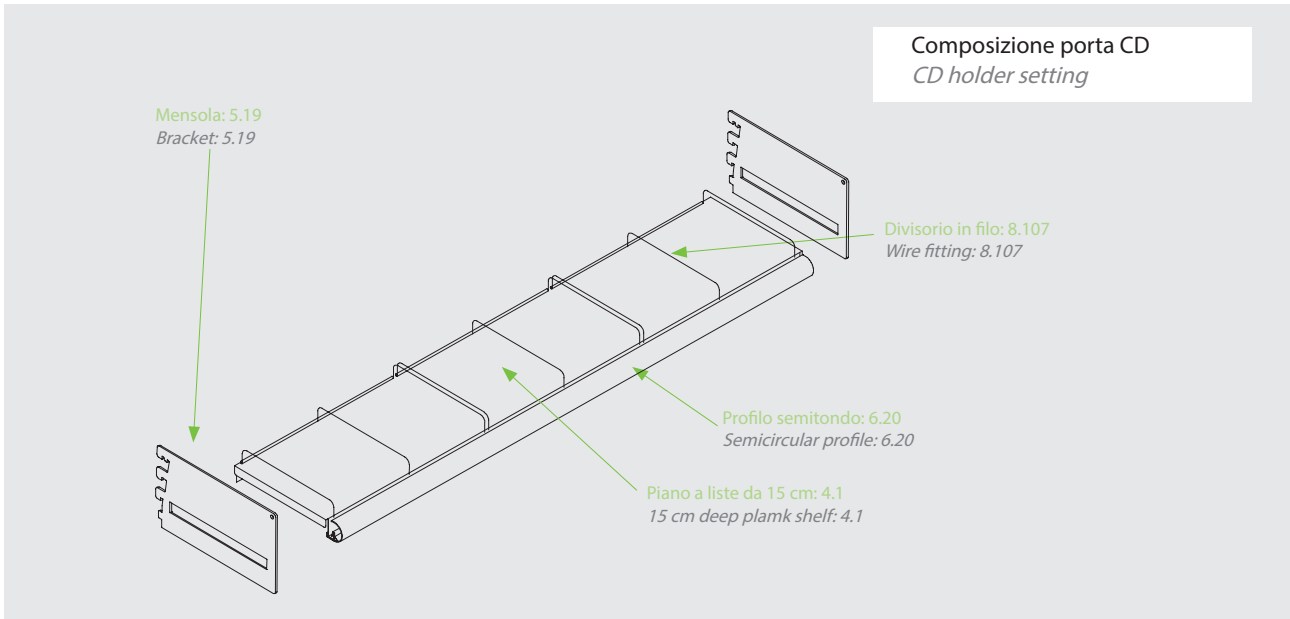

5.19

Mensola sponda a una feritoia inclinabile  
One slot retainer bracket

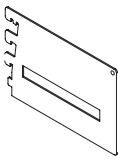
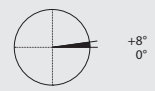

x	y	z	codice code	note notes
--	15	13,5	16.228	
--	20	13,5	16.227	

finitura finish	colori colours
V	2004
	6018
	6027
	• 7035
	AMA
	• ANT
	AZZ
	1001
	• BIA
	BLU
	GIA
	MAR
	• MTZ
	• PAN
	RO3
	BIMCL
	NRMCL
	• OXI

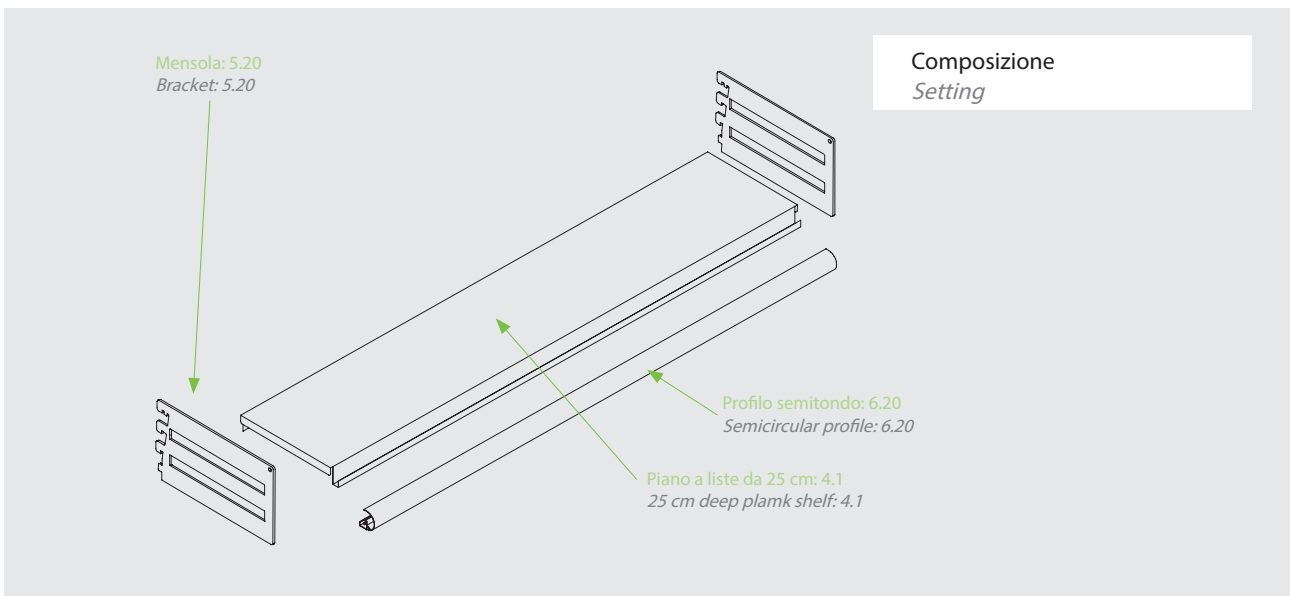

**Mensole Brackets**

**5.20**

**Mensola sponda a due feritoie inclinabile**  
**Two slot retainer bracket**

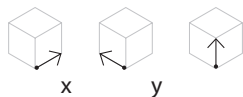
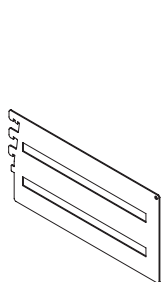
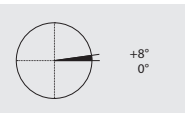

	x	y	z	codice code	note notes
--	25	17,7	16.-25		
--	30	17,7	16.-26		
--	35	17,7	16.-27		

finitura finish	colori colours
V	
	2004
	6018
	6027
	• 7035
	AMA
	• ANT
	AZZ
	1001
	• BIA
	BLU
	GIA
	MAR
	• MTZ
	• PAN
	RO3
	BIMCL
	NRMCL
	• OXI

**Composizione Setting**

Mensola: 5.21  
Bracket: 5.21

Piano a liste da 20 cm: 4.1  
20 cm deep plank shelf: 4.1

Profilo semitondo: 6.20  
Semicircular profile: 6.20

Piano a liste da 15 cm: 4.1  
15 cm deep plank shelf: 4.1

**Mensole Brackets**

**5.21**

**Mensola a "L"**  
**"L" shaped bracket**

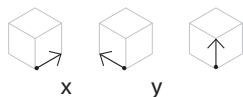
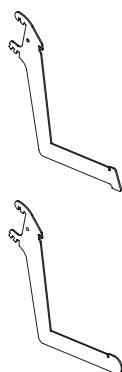
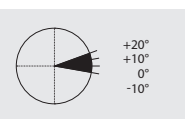

	x	y	z	codice code	note notes
testa inclinata sloped head	--	15	20	16.272	
	--	20	20	16.273	
testa tonda round head	--	15	20	16.270	
	--	20	20	16.271	

finitura finish	colori colours
V	
	2004
	6018
	6027
	• 7035
	AMA
	• ANT
	AZZ
	1001
	• BIA
	BLU
	GIA
	MAR
	• MTZ
	• PAN
	RO3
	BIMCL
	NRMCL
	• OXI

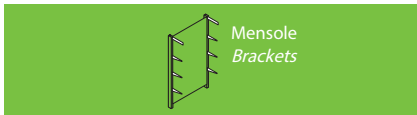
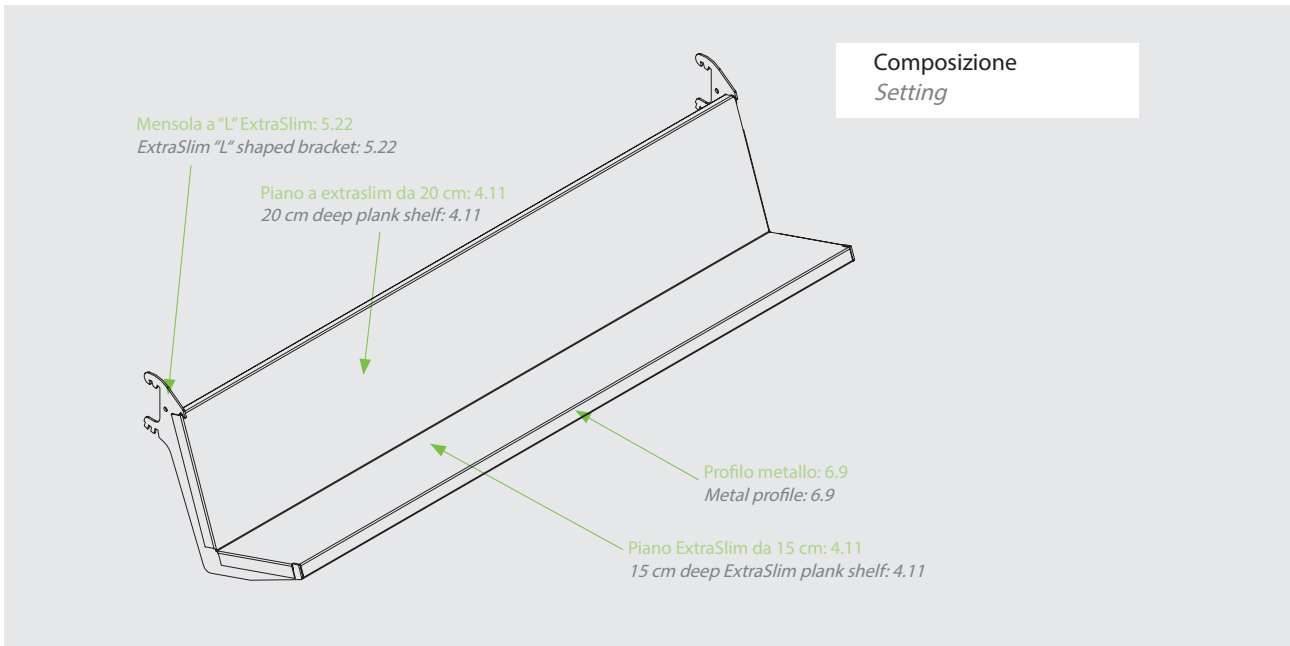

Mensole  
Brackets

5.22

Mensola a "L" ExtraSlim  
"L" ExtraSlim shaped bracket

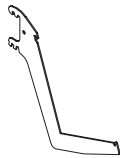
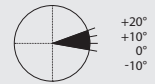

	x	y	z	codice code	note notes
testa diritta ExtraSlim head	--	15	20	16.425	
	--	20	20	16.423	



Per piano "L" ExtraSlim: 4.11  
For "L" ExtraSlim shelf: 4.11

finitura finish	colori colours
	V
	2004
	6018
	6027
	• 7035
	AMA
	• ANT
	AZZ
	1001
	• BIA
	BLU
	GIA
	MAR
	• MTZ
	• PAN
	RO3
	BIMCL
	NRMCL
	• OXI

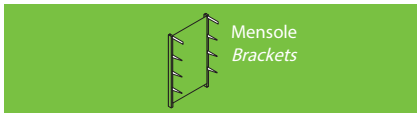

5.23

Mensola a due livelli per piano portariviste  
Two-steps bracket for magazine shelf

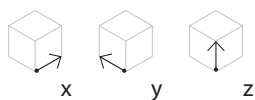
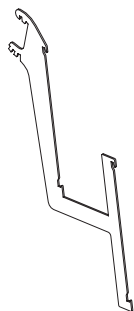

x	y	z	codice code	note notes
--	10	25	16.245	

Piano portariviste: 4.3  
Magazine shelf: 4.3

finitura finish	colori colours
V	2004
	6018
	6027
	• 7035
	AMA
	• ANT
	AZZ
	1001
	• BIA
	BLU
	GIA
	MAR
	• MTZ
	• PAN
	RO3
	BIMCL
	NRMCL
	• OXI



5.24

Mensola dx/sx per profilo portariviste  
Lh/rh bracket for magazine holder profile

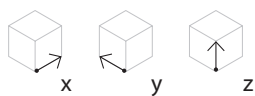
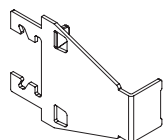

x	y	z	codice code	finitura e colore finish & colour	note notes
--	--	--	16.-53	C	

Profilo portariviste: 4.4  
Magazine holder profile: 4.4

**note**  
*notes*

# Profili *Profiles*

# 6



Profili per piani: profili in PVC inclinati, strisce di finitura in lamiera, profili in alluminio inclinati, profili semitondi e protezioni in PVC.

*Profiles for shelves: PVC profiles, finishing painted sheets, aluminium profiles, semicircular profiles and PVC protections.*







Profili  
Profiles

6.1

Profilo in PVC inclinato per piani a liste e piani in filo  
*PVC profile for plank shelf and wire shelves*

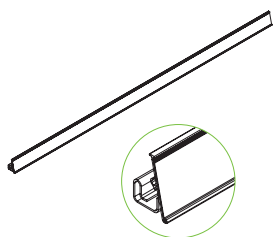

x	y	z	codice code	note notes	finitura finish	colori colours	colori colours
50	--	3,9	18.137		T		
66,5	--	3,9	18.138			7035	A838
75	--	3,9	18.136		•	ACE	999XA
100	--	3,9	18.135			BIA	995XM
133	--	3,9	18.134			FAG	989XR
						MTZ	994XS
						PAN	997XS
						A439	983XR
						ANT	984XA
						K101	BLACK
						3813	GREEN
						2293	BEIGE
						990XA	WHITE
						990XM	



Profili  
Profiles

6.2

Profilo in PVC inclinato per piano legno angolo chiuso  
*PVC profile for wooden closed corner shelf*

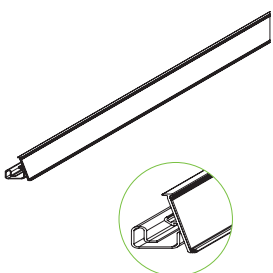

x	y	z	codice code	note notes	finitura finish	colori colours	colori colours
25	--	3,9	18.228		T		
30	--	3,9	18.229			7035	A838
35	--	3,9	18.230		•	ACE	999XA
40	--	3,9	18.231			BIA	995XM
50	--	3,9	18.232			FAG	989XR
60	--	3,9	18.233			MTZ	994XS
						PAN	997XS
						A439	983XR
						ANT	984XA
						K101	BLACK
						3813	GREEN
						2293	BEIGE
						990XA	WHITE
						990XM	



Profili  
Profiles

6.3

Profilo in PVC inclinato per piano legno angolo aperto  
*PVC profile for wooden open corner shelf*

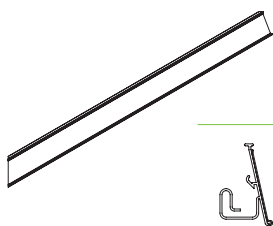

x	y	z	codice code	note notes	finitura finish	colori colours	colori colours
25	--	3,9	18.210		T		
30	--	3,9	18.211			7035	A838
35	--	3,9	18.212		•	ACE	999XA
40	--	3,9	18.213			BIA	995XM
50	--	3,9	18.214			FAG	989XR
60	--	3,9	18.215			MTZ	994XS
						PAN	997XS
						A439	983XR
						ANT	984XA
						K101	BLACK
						3813	GREEN
						2293	BEIGE
						990XA	WHITE
						990XM	



6.4

Profilo in PVC inclinato per piani interi  
*PVC profile for one piece shelf*

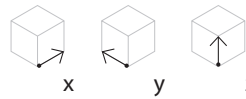
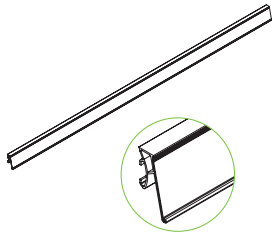

x	y	z	codice code
66,5	--	3,9	18.158
100	--	3,9	18.157
133	--	3,9	18.156

note notes

finitura finish

colori colours

colori colours

note notes	finitura finish	colori colours	colori colours
	T		
		7035	A838
		ACE	999XA
	•	BIA	995XM
		FAG	989XR
		MTZ	994XS
		PAN	997XS
		A439	983XR
		ANT	984XA
		K101	BLACK
		3813	GREEN
		2293	BEIGE
		990XA	WHITE
		990XM	



6.5

Profilo in PVC inclinato per piano intero curvo  
*PVC profile for one piece curved shelf*

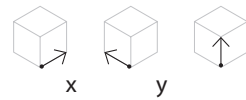
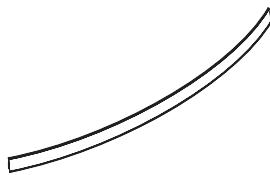

x	y	z	codice code
101,7	--	3,9	18.190
134,1	--	3,9	18.191

note notes

finitura finish

colori colours

colori colours

note notes	finitura finish	colori colours	colori colours
	T		
	•		BIA



6.6

Profilo in PVC inclinato per piano metallo angolo chiuso 90°  
*PVC profile for metal closed corner shelf*

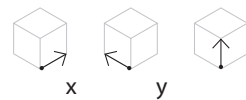
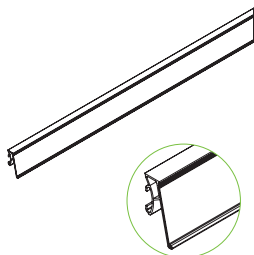

x	y	z	codice code
25	--	3,9	18.337
30	--	3,9	18.338
35	--	3,9	18.339
40	--	3,9	18.340
50	--	3,9	18.341
60	--	3,9	18.342

note notes

finitura finish

colori colours

colori colours

note notes	finitura finish	colori colours	colori colours
	T		
		7035	A838
		ACE	999XA
	•	BIA	995XM
		FAG	989XR
		MTZ	994XS
		PAN	997XS
		A439	983XR
		ANT	984XA
		K101	BLACK
		3813	GREEN
		2293	BEIGE
		990XA	WHITE
		990XM	



Profili  
Profiles

6.7

Profilo in PVC inclinato per piano metallo angolo aperto 90°  
PVC profile for metal open corner shelf

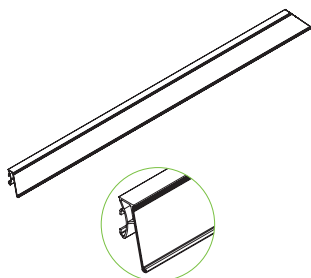

x	y	z	codice code	note notes	finitura finish	colori colours	colori colours
25	--	3,9	18.331		T		
30	--	3,9	18.332			7035	A838
35	--	3,9	18.333		•	ACE	999XA
40	--	3,9	18.334			BIA	995XM
50	--	3,9	18.335			FAG	989XR
60	--	3,9	18.336			MTZ	994XS
						PAN	997XS
						A439	983XR
						ANT	984XA
						K101	BLACK
						3813	GREEN
						2293	BEIGE
						990XA	WHITE
						990XM	



Profili  
Profiles

6.8

Striscia di finitura in ABS per piano intero  
Finishing ABS strip

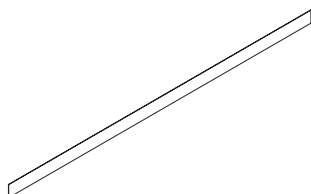

x	y	z	codice code	note notes	finitura finish	colori colours
100	--	3,7	35.149		T	
133	--	3,7	35.150		•	7035
					•	ACE
					•	BIA
						FAG
					•	MTZ
					•	PAN
					•	A439
					•	ANT
						K101
						3813
						2293
						990XA
						990XM
						A838
						999XA
						995XM
						989XR
						994XS
						997XS
						983XR
						984XA
						BLACK
						GREEN
						BEIGE
						WHITE

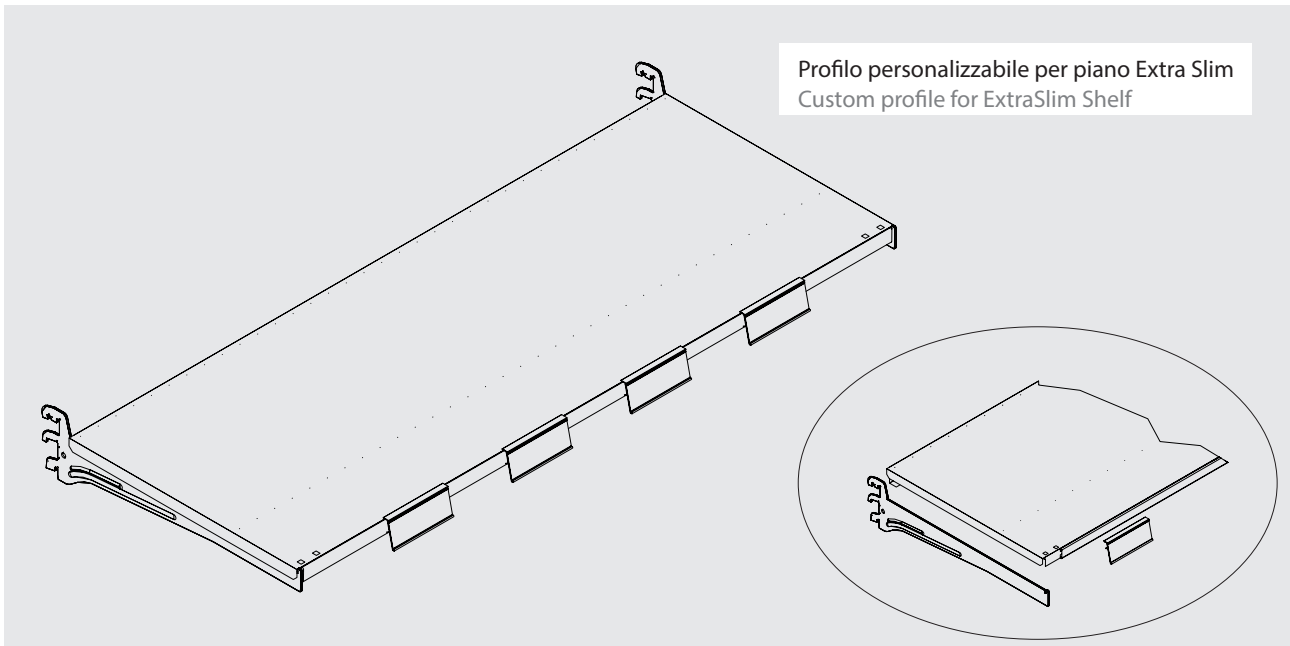

Profilo personalizzabile per piano Extra Slim  
Custom profile for ExtraSlim Shelf

**6.9** Profilo metallo ExtraSlim  
Metal profile for ExtraSlim

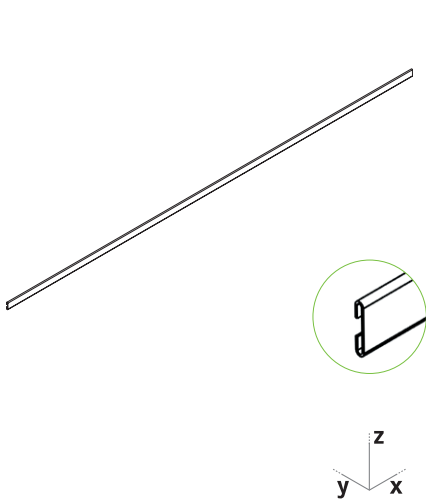

x	y	z	codice code	note notes
50	--	2,1	18.326	
66,5	--	2,1	18.323	
75	--	2,1	18.325	
100	--	2,1	18.321	
133	--	2,1	18.320	

finitura finish	colori colours
P	V
	2004
	6018
	6027
•	7035
	AMA
•	ANT
	AZZ
	1001
•	BIA
	BLU
	GIA
	MAR
	• MTZ
•	PAN
	RO3
	BIMCL
	NRMCL
•	OXI

**6.10** Porta prezzo per profilo metallo ExtraSlim  
Price holder for metal ExtraSlim Profile

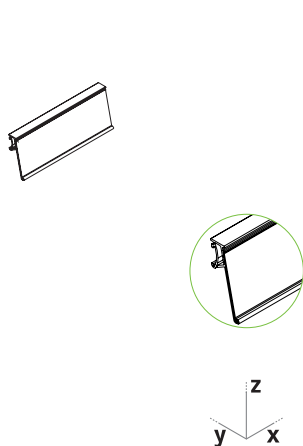

x	y	z	codice code	finitura e colore finish & colour	note notes
4,8	--	3,9	18.330	TTRA	

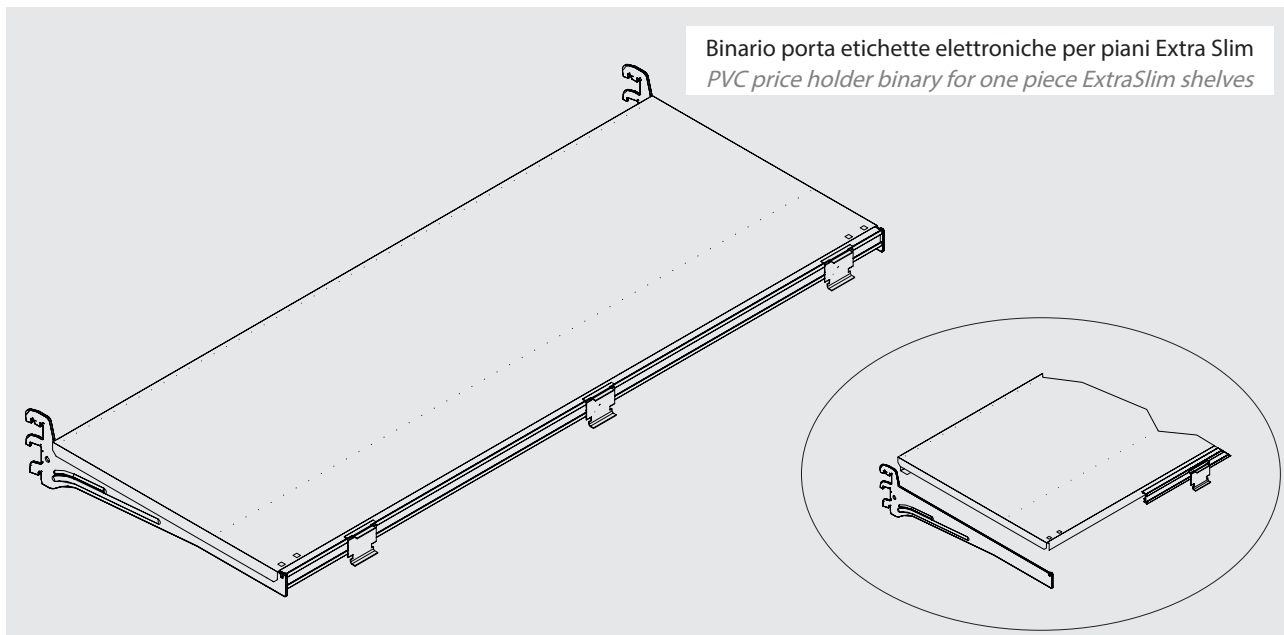

**Binario porta etichette elettroniche per piani Extra Slim**  
*PVC price holder binary for one piece ExtraSlim shelves*



**6.11**

**Binario biestruso PVC portaetichette per piani Extra Slim**  
*PVC price holder binary for one piece ExtraSlim shelves*

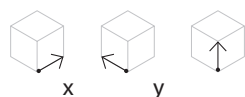
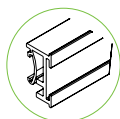
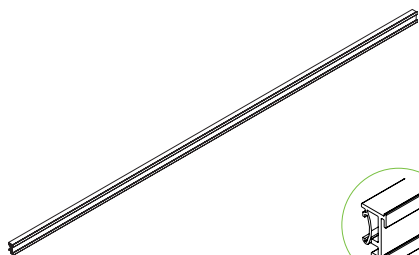

x	y	z	codice code	note notes
66,5	--	1,9	18.369	TTRA
100	--	1,9	18.367	TTRA
133	--	1,9	18.368	TTRA



Profili  
Profiles

6.13

Profilo in alluminio inclinato per piani a liste  
*Aluminium profile for plank shelf*

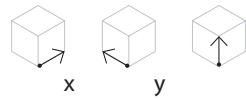
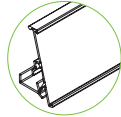
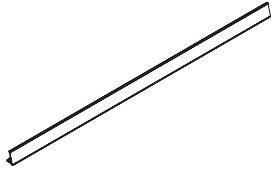

	x	y	z	codice code	finitura e colore finish & colour	note notes
50	--	--	3,9	18.172	N	
66,5	--	--	3,9	18.263	N	
75	--	--	3,9	18.175	N	
100	--	--	3,9	18.174	N	
133	--	--	3,9	18.176	N	



Profili  
Profiles

6.14

Profilo in alluminio inclinato per piano legno angolo chiuso  
*Aluminium profile for wooden closed corner shelf*

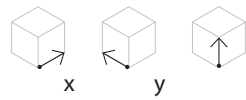
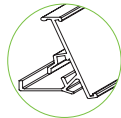
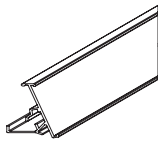

	x	y	z	codice code	finitura e colore finish & colour	note notes
25	--	--	3,9	18.234	N	
30	--	--	3,9	18.235	N	
35	--	--	3,9	18.236	N	
40	--	--	3,9	18.237	N	
50	--	--	3,9	18.238	N	
60	--	--	3,9	18.239	N	



Profili  
Profiles

6.15

Profilo in alluminio inclinato per piano legno angolo aperto  
*Aluminium profile for wooden open corner shelf*

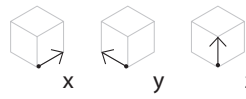
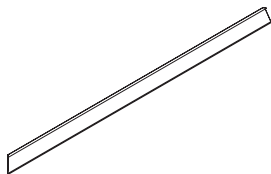

	x	y	z	codice code	finitura e colore finish & colour	note notes
25	--	--	3,9	18.216	N	
30	--	--	3,9	18.217	N	
35	--	--	3,9	18.218	N	
40	--	--	3,9	18.219	N	
50	--	--	3,9	18.220	N	
60	--	--	3,9	18.221	N	



6.16

Profilo in alluminio inclinato per piano intero  
*Aluminium profile for one piece shelf*

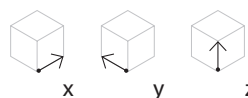
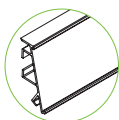
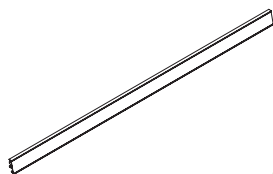

	x	y	z	codice code	finitura e colore finish & colour	note notes
66,5	--	3,9	18.201	N		
100	--	3,9	18.180	N		
133	--	3,9	18.183	N		



6.17

Profilo in alluminio inclinato per piano metallo angolo chiuso 90°  
*Aluminium profile for metal closed corner shelf*

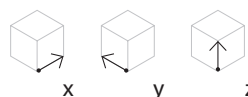
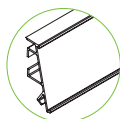
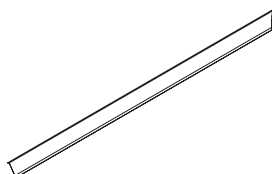

	x	y	z	codice code	finitura e colore finish & colour	note notes
25	--	3,9	18.349	N		
30	--	3,9	18.350	N		
35	--	3,9	18.351	N		
40	--	3,9	18.352	N		
50	--	3,9	18.353	N		
60	--	3,9	18.354	N		



6.18

Profilo in alluminio inclinato per piano metallo angolo aperto 90°  
*Aluminium profile for metal open corner shelf*

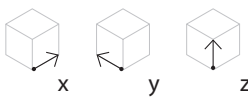
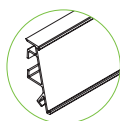
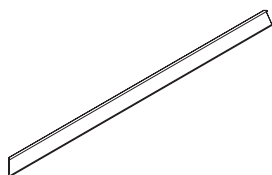

	x	y	z	codice code	finitura e colore finish & colour	note notes
25	--	3,9	18.343	N		
30	--	3,9	18.344	N		
35	--	3,9	18.345	N		
40	--	3,9	18.346	N		
50	--	3,9	18.347	N		
60	--	3,9	18.348	N		







Profili  
Profiles

6.22

Profilo semitondo per piano legno angolo aperto  
*Semicircular profile for wooden open corner shelf*

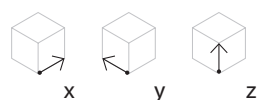
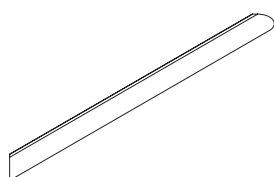

x	y	z	codice code	note notes
25	--	--	18.222	
30	--	--	18.223	
35	--	--	18.224	
40	--	--	18.225	
50	--	--	18.226	
60	--	--	18.227	

finitura finish	colori colours
V	2004
	6018
	6027
	• 7035
	AMA
	• ANT
	AZZ
	1001
	• BIA
	BLU
	GIA
	MAR
	• MTZ
	• PAN
	RO3
	BIMCL
	NRMCL
	• OXI



Profili  
Profiles

6.23

Profilo semitondo per piano intero  
*Semicircular profile for one piece shelf*

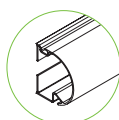
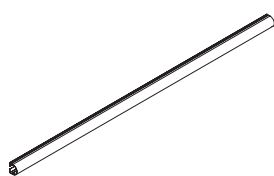

x	y	z	codice code	note notes
66,5	--	--	18.185	
100	--	--	18.184	
133	--	--	18.186	

finitura finish	colori colours
V	2004
	6018
	6027
	• 7035
	AMA
	• ANT
	AZZ
	1001
	• BIA
	BLU
	GIA
	MAR
	• MTZ
	• PAN
	RO3
	BIMCL
	NRMCL
	• OXI



Profili  
Profiles

6.24

Profilo semitondo per piano metallo angolo chiuso 90°  
*Semicircular profile for metal closed corner shelf*

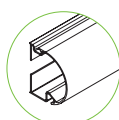
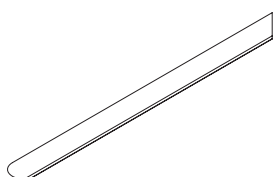

x	y	z	codice code	finitura e colore finish & colour	note notes
25	--	--	18.361	N	
30	--	--	18.362	N	
35	--	--	18.363	N	
40	--	--	18.364	N	
50	--	--	18.365	N	
60	--	--	18.366	N	



6.25

Profilo semitondo per piano metallo angolo aperto 90°  
*Semicircular profile for metal open corner shelf*

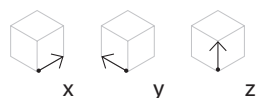
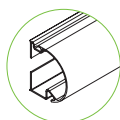
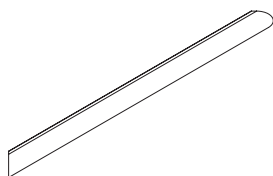

	x	y	z	codice code	finitura e colore finish & colour	note notes
25	--	--	--	18.355	N	
30	--	--	--	18.356	N	
35	--	--	--	18.357	N	
40	--	--	--	18.358	N	
50	--	--	--	18.359	N	
60	--	--	--	18.360	N	



6.26

Protezione in PVC per il profilo semitondo  
*PVC protection for semicircular profiles*

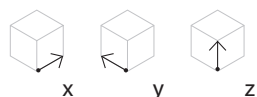
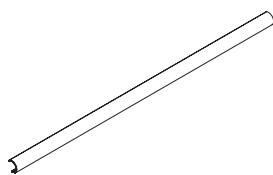

	x	y	z	codice code	finitura e colore finish & colour	note notes
10,5	--	--	--	18.164	T TRA	
50	--	--	--	18.163	T TRA	
75	--	--	--	18.161	T TRA	
100	--	--	--	18.160	T TRA	



6.27

Profilo in PVC inclinato ad innesto per piano in vetro  
*PVC profile for glass shelf*

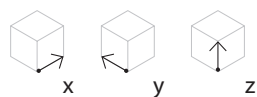
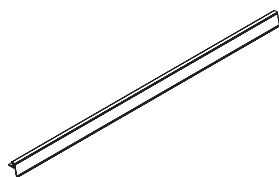

	x	y	z	codice code	finitura e colore finish & colour	note notes
66,5	--	--	3,9	18.329	TTRA	
75	--	--	3,9	18.328	TTRA	
100	--	--	3,9	18.327	TTRA	



Profili  
Profiles

6.28

Profilo in alluminio ad innesto con led integrato per piano in vetro  
Aluminium profile with LED lamp for glass shelf

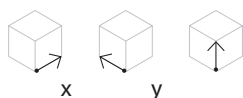
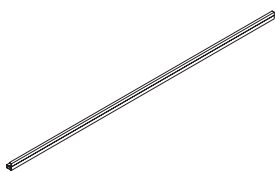

x	y	z	codice code	note notes
66,5	--	3,9	18.375	N
75	--	3,9	18.374	N
100	--	3,9	18.373	N



Profili  
Profiles

6.29

Profilo in PVC inclinato per piano in vetro  
PVC profile for glass shelf

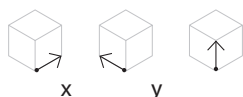
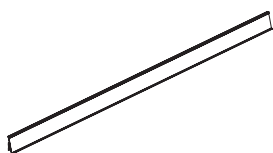

x	y	z	codice code	note notes	finitura finish	colori colours
50	--	3,9	18.192		T	
75	--	3,9	18.171		•	BIA
100	--	3,9	18.149		•	TRA
						NER
						--
						-

Da usare con traverso cavettato anteriore 4.21  
To be used with front cross piece for glass shelf: 4.21

T TRA solo per 18.150  
T TRA only for 18.150

**note**  
*notes*

# Cielini

## *Shelf heads*

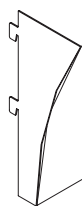
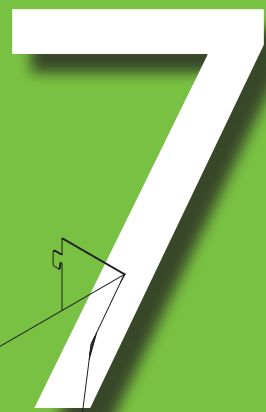

Mensole cielino, fasce cielino, perspex per fasce cielino e accessori per l'illuminazione. Pannelli didattici e specchi.

*Brackets for canopy fronts, canopy fronts, perspex for canopy front and lighting accessories. Information panels and mirrors.*



Gruppi cielino con mensole inclinate e accessori  
*Shelf heads with angled brackets and accessories*

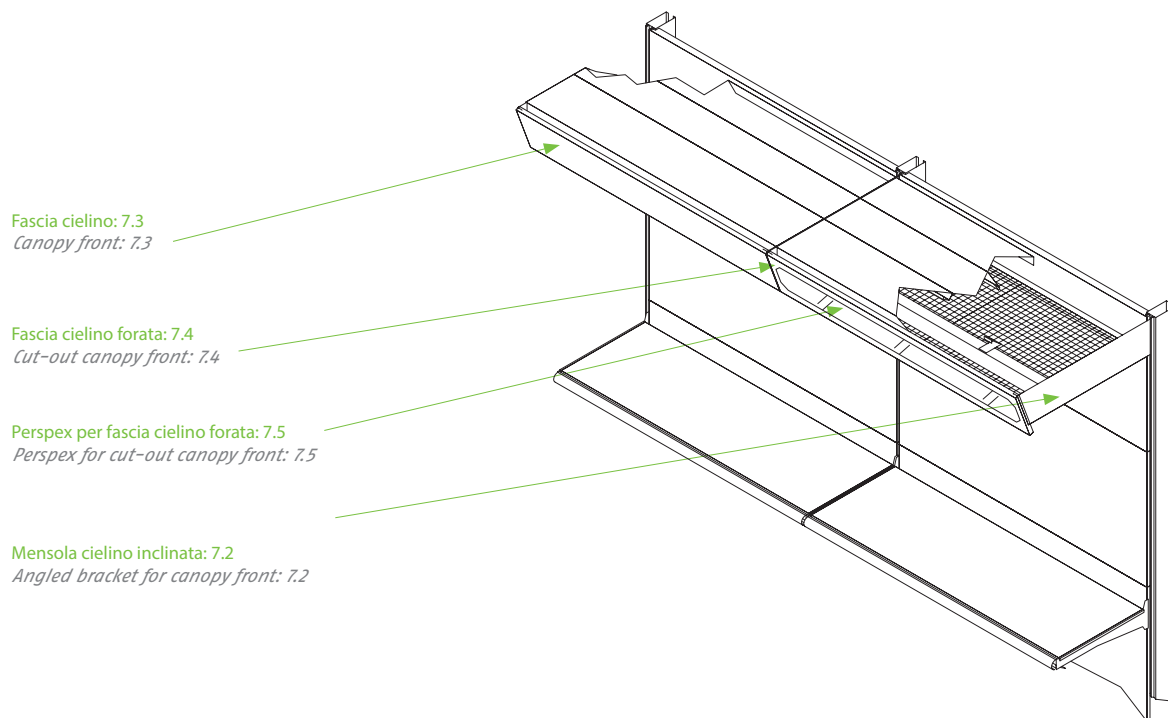

Fascia cielino: 7.3  
*Canopy front: 7.3*

Fascia cielino forata: 7.4  
*Cut-out canopy front: 7.4*

Perspex per fascia cielino forata: 7.5  
*Perspex for cut-out canopy front: 7.5*

Mensola cielino inclinata: 7.2  
*Angled bracket for canopy front: 7.2*

Gruppi cielino con mensole dritte e accessori  
*Shelf heads with straight brackets and accessories*

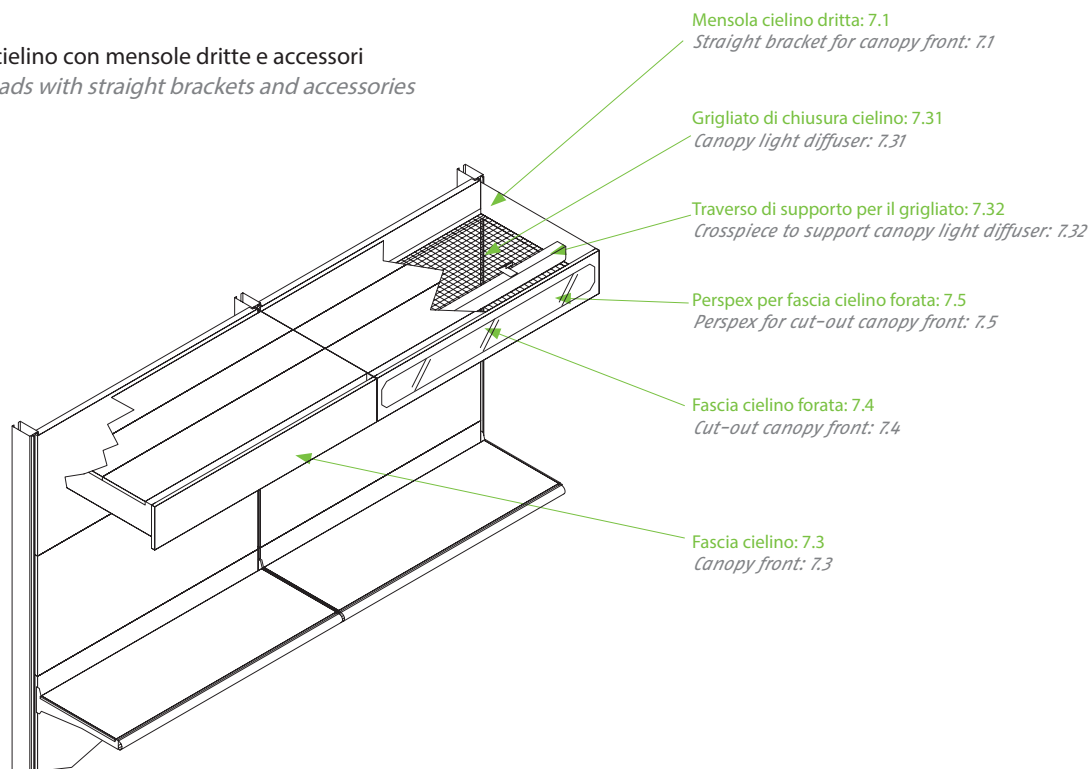

Mensola cielino dritta: 7.1  
*Straight bracket for canopy front: 7.1*

Grigliato di chiusura cielino: 7.31  
*Canopy light diffuser: 7.31*

Traverso di supporto per il grigliato: 7.32  
*Crosspiece to support canopy light diffuser: 7.32*

Perspex per fascia cielino forata: 7.5  
*Perspex for cut-out canopy front: 7.5*

Fascia cielino forata: 7.4  
*Cut-out canopy front: 7.4*

Fascia cielino: 7.3  
*Canopy front: 7.3*

Composizione con fascia cielino stondata, mensola cielino dritta  
*Shelf heads with rounded canopy front, with straight brackets*

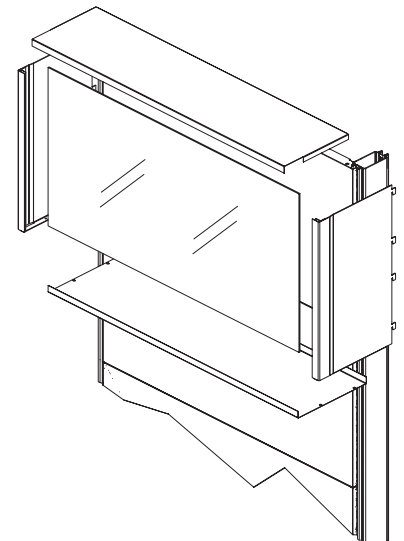
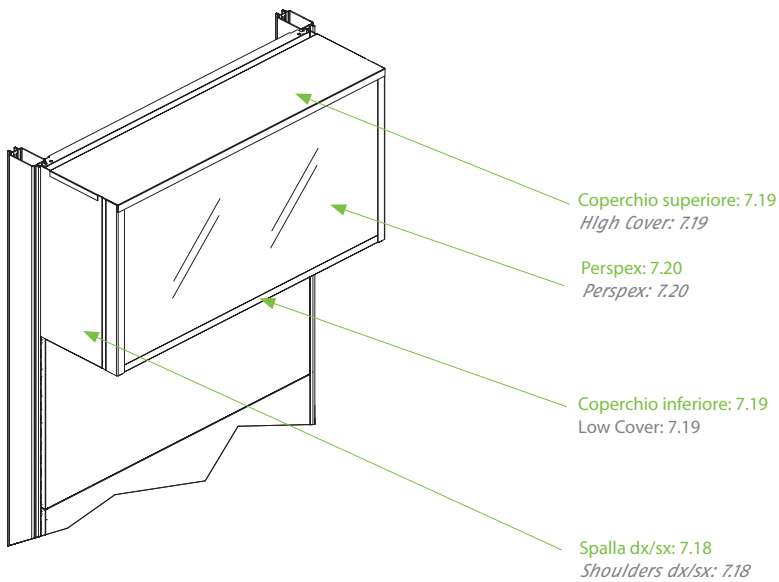
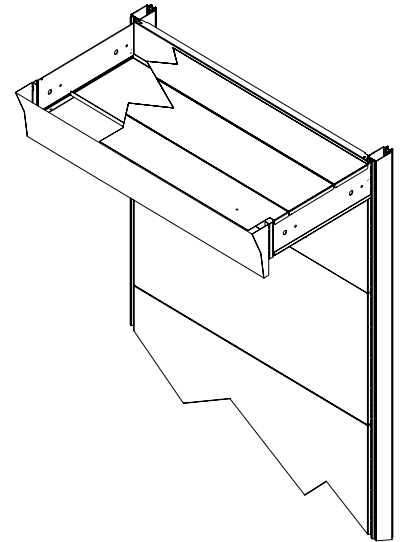
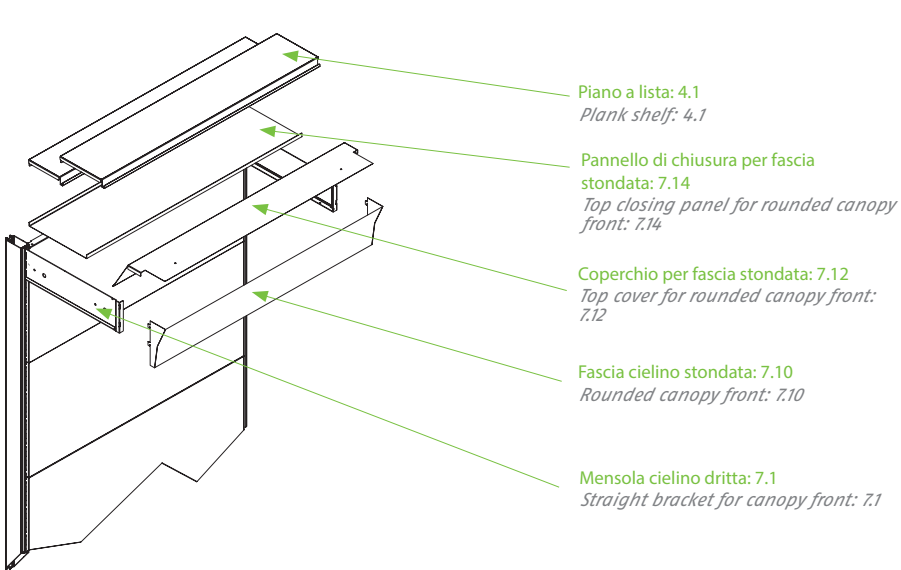

Cielino vela curvo h 55 cm  
*Circular canopy h 55 cm*

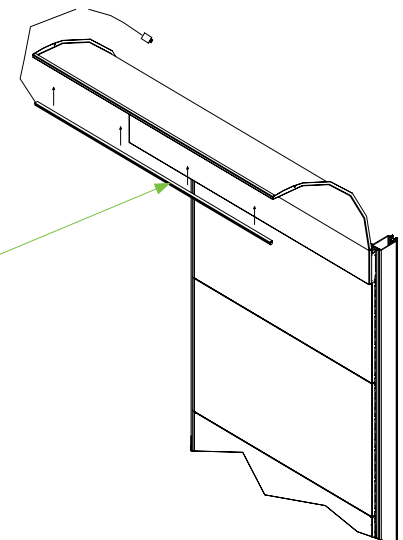
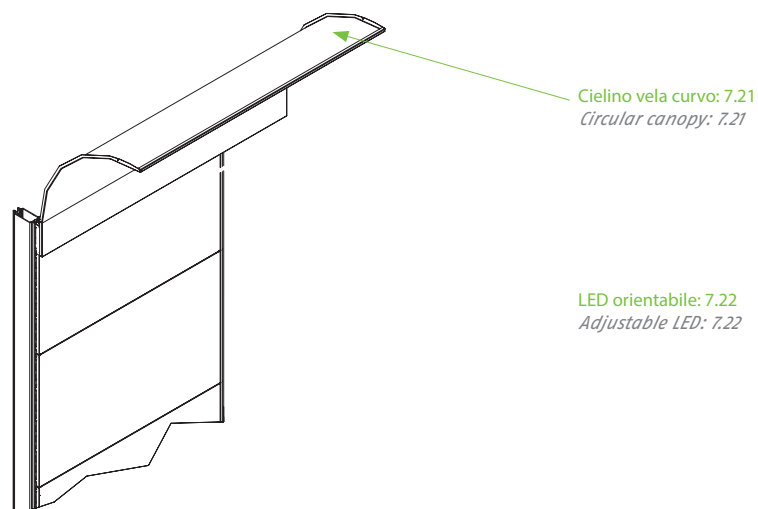



Composizione cielini con fasce cielino h 13 e h 17, con mensole inclinate  
Shelf heads with 13/17 cm high fronts, with angled brackets

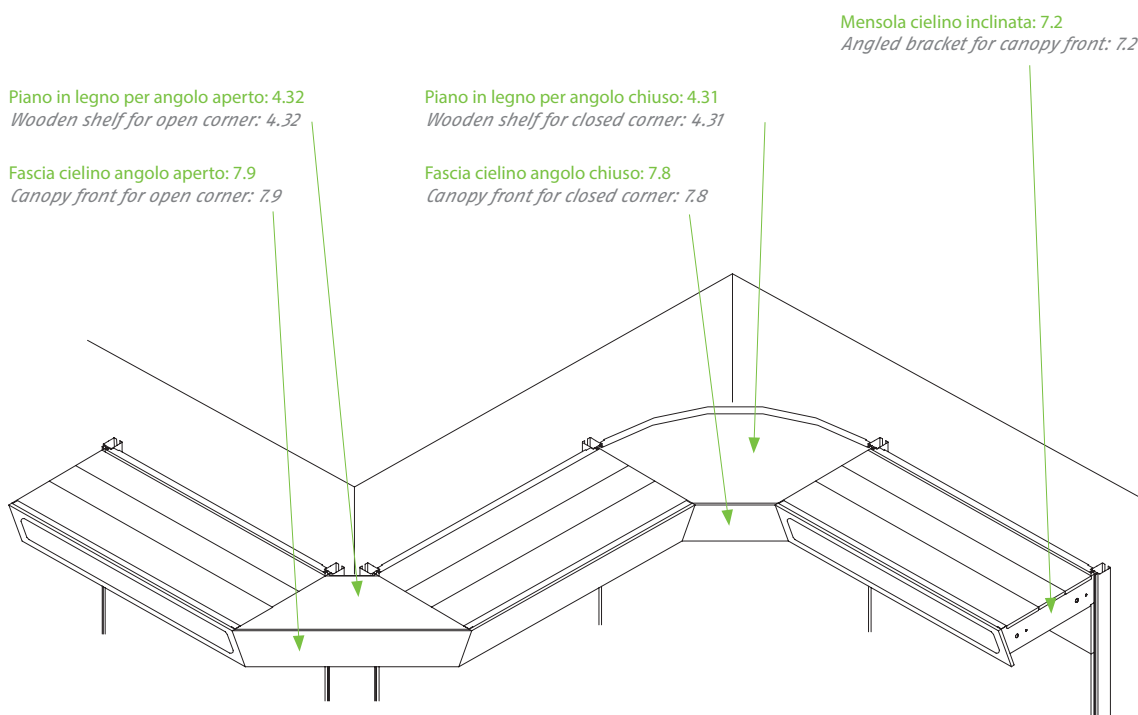

Composizione cielini con fasce cielino h 13 e h 17, con mensole dritte  
Shelf heads with 13/17 cm high fronts, with straight brackets

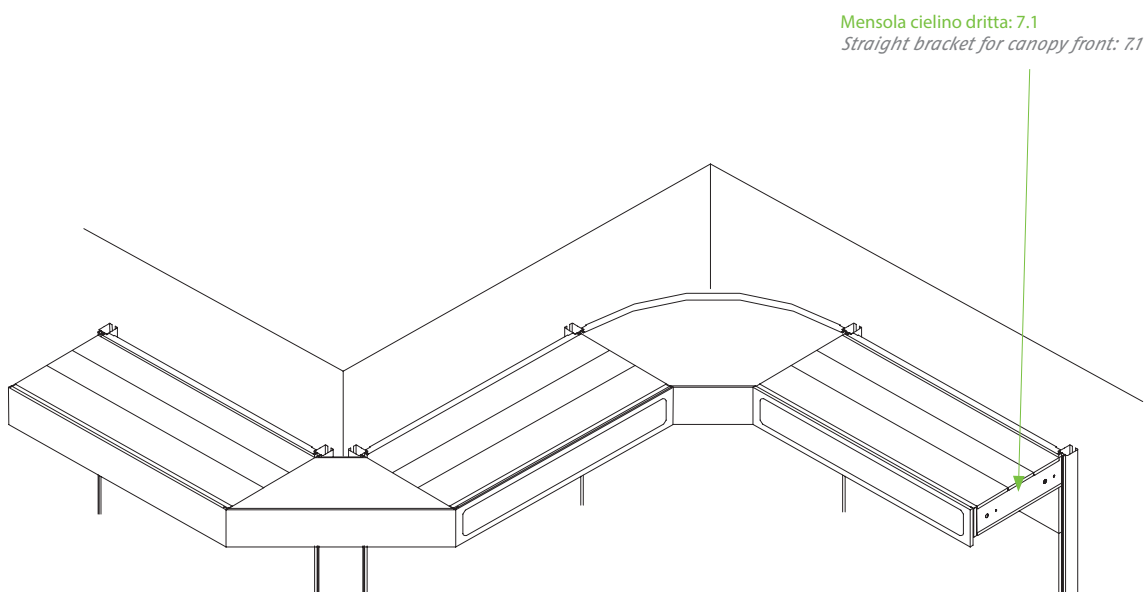

Composizione ciellini con fasce cielino h 13 e h 17, con mensole inclinate  
*Shelf heads with 13/17 cm high fronts, with angled brackets*

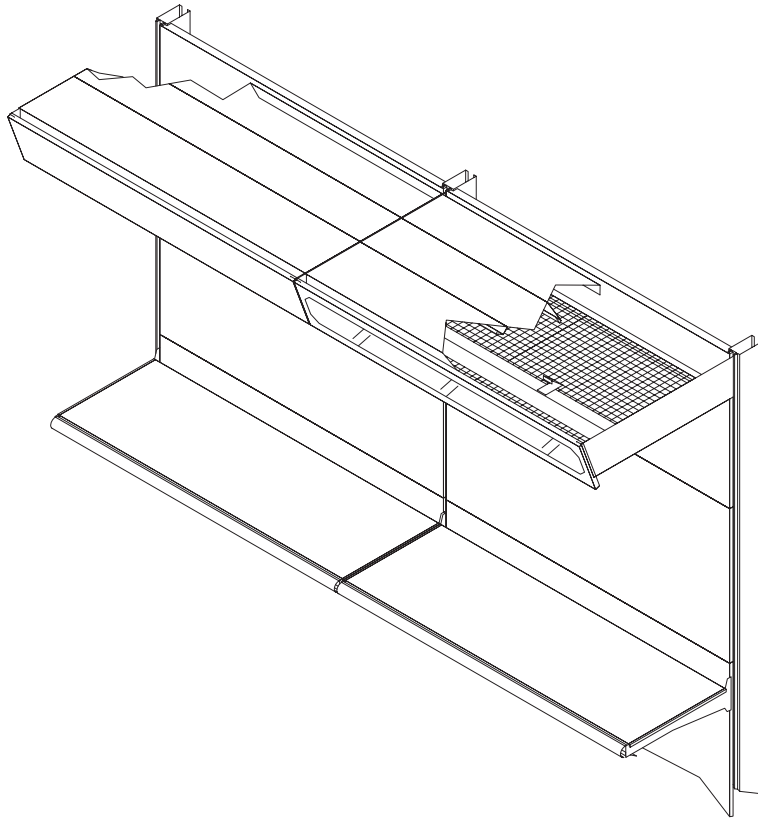

Composizione ciellini con fasce cielino h 13 e h 17, con mensole dritte  
*Shelf heads with 13/17 cm high fronts, with straight brackets*

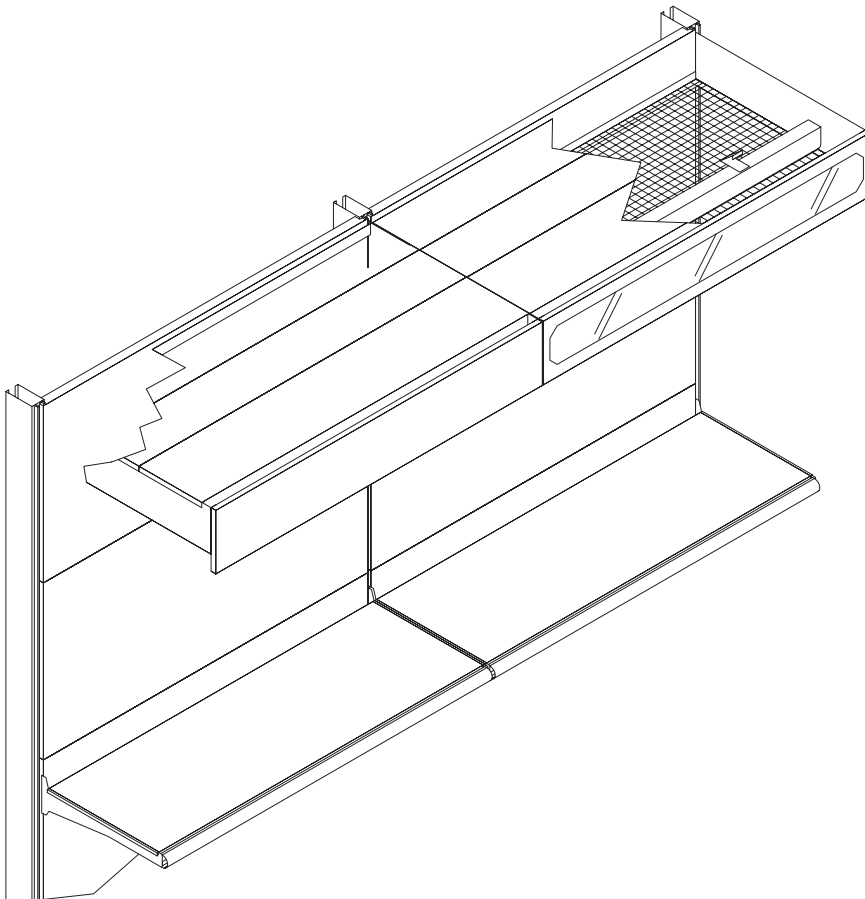





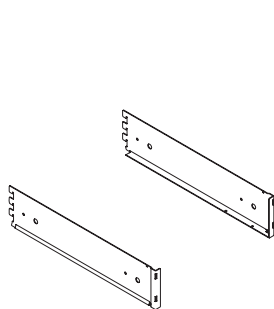

Cielini  
Shelf Heads

## 7.1

Mensola cielino dritta  
Straight bracket for canopy front



				codice code	note notes
	x	y	z		
dx rh	--	40	12	16.214	
sx lh	--	40	12	16.215	
dx rh	--	50	12	16.216	
sx lh	--	50	12	16.217	
dx rh	--	60	12	16.199	
sx lh	--	60	12	16.200	

finitura finish	colori colours
V	2004
	6018
	6027
	• 7035
	AMA
	• ANT
	AZZ
	1001
	• BIA
	BLU
	GIA
	MAR
	• MTZ
	• PAN
	RO3
	BIMCL
	NRMCL
	• OXI





Cielini  
Shelf Heads

## 7.2

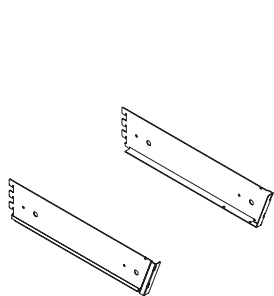
Mensola cielino inclinata  
Angled bracket for canopy front



				codice code	note notes
	x	y	z		
dx rh	--	40	12	16.208	
sx lh	--	40	12	16.209	
dx rh	--	50	12	16.210	
sx lh	--	50	12	16.211	
dx rh	--	60	12	16.212	
sx lh	--	60	12	16.213	

finitura finish	colori colours
V	2004
	6018
	6027
	• 7035
	AMA
	• ANT
	AZZ
	1001
	• BIA
	BLU
	GIA
	MAR
	• MTZ
	• PAN
	RO3
	BIMCL
	NRMCL
	• OXI



7.3

Fascia cielino / Zoccolo per basi h 17 , h 23  
Canopy front / Plinth for 17/23 cm high bases

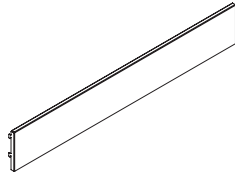
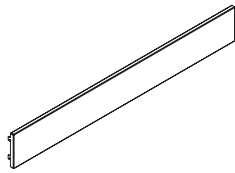

x	y	z	codice code	note notes
50	--	13	15.129	
66,5	--	13	15.-83	
75	--	13	15.128	
100	--	13	15.-82	
133	--	13	15.-84	
50	--	17	15.136	
66,5	--	17	15.-80	
75	--	17	15.135	
100	--	17	15.-79	
133	--	17	15.-81	

finitura finish	colori colours
P	V
	2004
	6018
	6027
•	7035
	AMA
	• ANT
	AZZ
	1001
•	BIA
	BLU
	GIA
	MAR
	• MTZ
•	PAN
	RO3
	BIMCL
	NRMCL
	• OXI

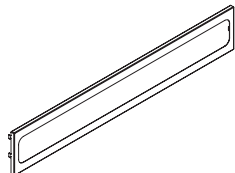
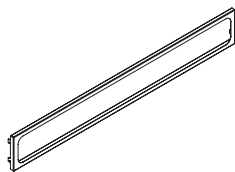

7.4

Fascia cielino forata  
Cut-out canopy front

x	y	z	codice code	note notes
50	--	13	20.165	
66,5	--	13	20.166	
75	--	13	20.164	
100	--	13	20.163	
133	--	13	20.167	
50	--	17	20.160	
66,5	--	17	20.161	
75	--	17	20.159	
100	--	17	20.158	
133	--	17	20.162	

finitura finish	colori colours
	V
	2004
	6018
	6027
•	7035
	AMA
•	ANT
	AZZ
	1001
•	BIA
	BLU
	GIA
	MAR
•	MTZ
•	PAN
	RO3
	BIMCL
	NRMCL
•	OXI

Cielini  
Shelf Heads

7.5

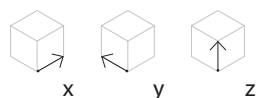
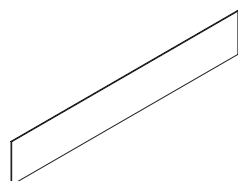
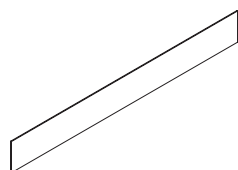
Perspex per fascia cielino forata  
*Perspex for cut-out canopy front*

x	y	z	codice code	finitura e colore finish & colour	note notes
50	0,3	13	20.181	T TRA	
66,5	0,3	13	20.315	T TRA	
75	0,3	13	20.180	T TRA	
100	0,3	13	20.179	T TRA	
133	0,3	13	20.183	T TRA	
50	0,3	17	20.100	T TRA	
66,5	0,3	17	20.102	T TRA	
75	0,3	17	20.-91	T TRA	
100	0,3	17	20.-92	T TRA	
133	0,3	17	20.-93	T TRA	

Cielini  
Shelf Heads

7.6

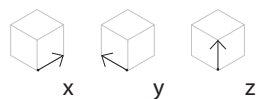
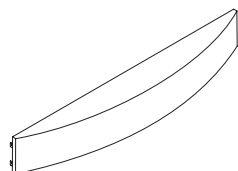
Fascia cielino in metallo con bordo anteriore curvo  
*Curved metal canopy front*

x	y	z	codice code	note notes	finitura finish	colori colours
100	--	13	20.125		V	
133	--	13	20.124			2004 6018 6027 • 7035 AMA • ANT AZZ 1001 • BIA BLU GIA MAR • MTZ • PAN RO3 BIMCL NRMCL • OXI

Cielini  
Shelf Heads

7.7

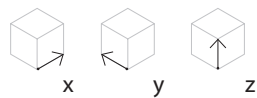
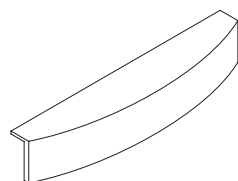
Fascia cielino in legno per piano con bordo anteriore curvo  
*Curved wooden canopy front for curved shelf*

x	y	z	codice code	note notes	finitura finish	colori colours
100	--	17	20.196		T	
133	--	17	20.195			• NOC

Da usare con struttura  
Minirack  
*To be used with  
Minirack units*



7.8

Fascia cielino angoli chiusi curvo  
Canopy front for closed corner

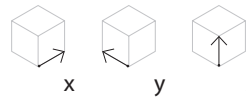
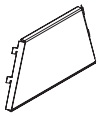
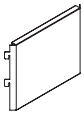

	x	y	z	codice code	note notes
mensola dritta straight bracket	40	--	13	20.212	
	50	--	13	20.213	
	60	--	13	20.214	
	40	--	17	20.215	
	50	--	17	20.216	
	60	--	17	20.217	
mensola inclinata angled bracket	40	--	13	20.218	
	50	--	13	20.219	
	60	--	13	20.220	
	40	--	17	20.221	
	50	--	17	20.222	
	60	--	17	20.223	

finitura finish	colori colours
P	V
	2004
	6018
	6027
•	7035
	AMA
•	ANT
	AZZ
	1001
•	BIA
	BLU
	GIA
	MAR
•	MTZ
•	PAN
	RO3
	BIMCL
	NRMCL
	• OXI



7.9

Fascia cielino angoli aperti  
Canopy front for open corner

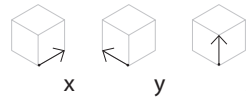
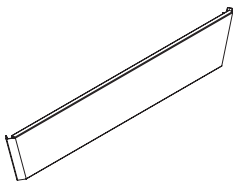
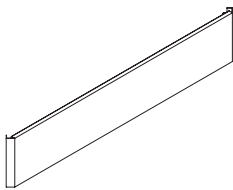

	x	y	z	codice code	note notes
mensola dritta straight bracket	40	--	13	20.224	
	50	--	13	20.225	
	60	--	13	20.226	
	40	--	17	20.227	
	50	--	17	20.228	
	60	--	17	20.229	
mensola inclinata angled bracket	40	--	13	20.230	
	50	--	13	20.231	
	60	--	13	20.232	
	40	--	17	20.233	
	50	--	17	20.234	
	60	--	17	20.235	

finitura finish	colori colours
P	V
	2004
	6018
	6027
•	7035
	AMA
•	ANT
	AZZ
	1001
•	BIA
	BLU
	GIA
	MAR
•	MTZ
•	PAN
	RO3
	BIMCL
	NRMCL
	• OXI

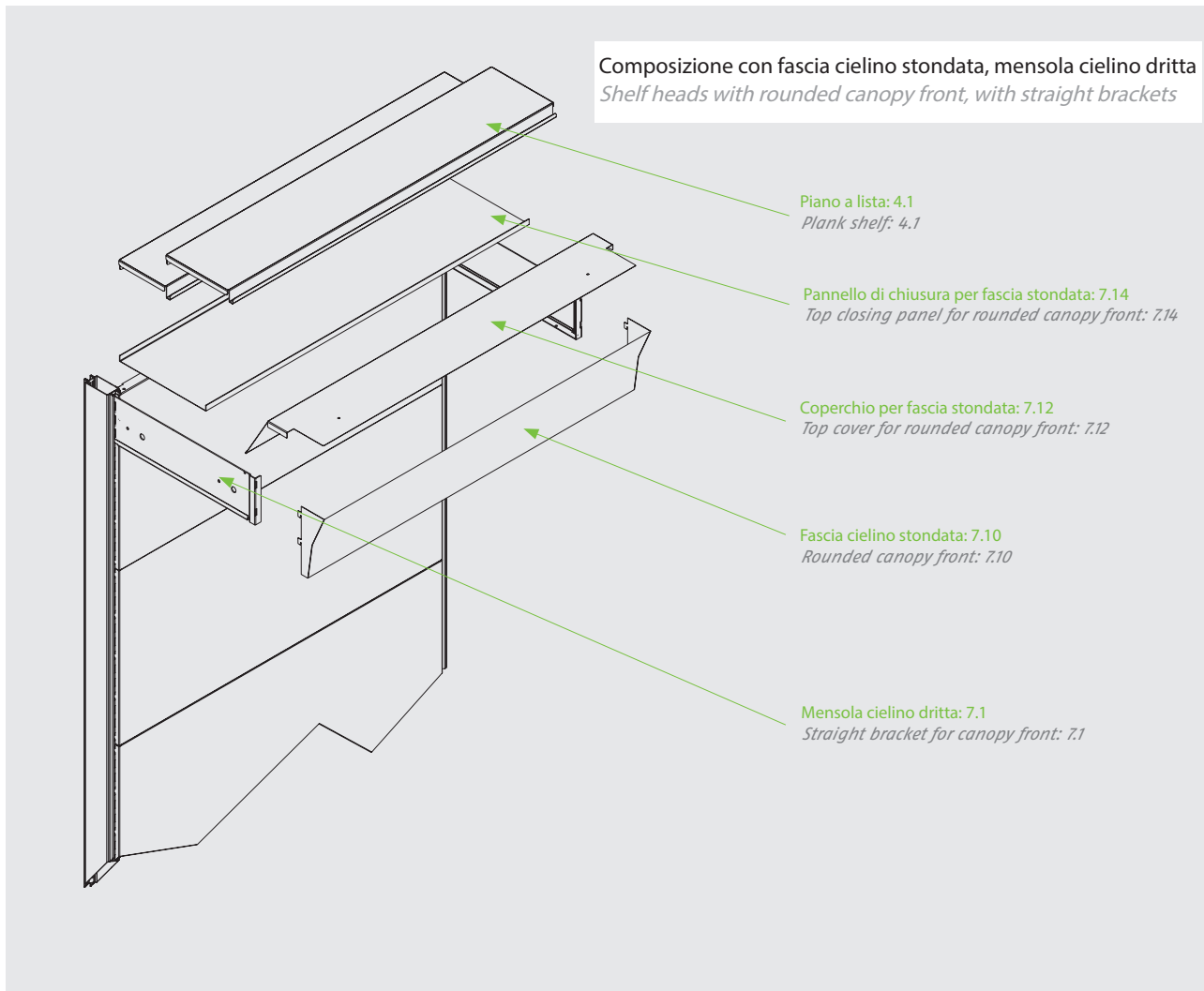

Composizione con fascia cielino stondata, mensola cielino dritta  
Shelf heads with rounded canopy front, with straight brackets

Piano a lista: 4.1  
Plank shelf: 4.1

Pannello di chiusura per fascia stondata: 7.14  
Top closing panel for rounded canopy front: 7.14

Coperchio per fascia stondata: 7.12  
Top cover for rounded canopy front: 7.12

Fascia cielino stondata: 7.10  
Rounded canopy front: 7.10

Mensola cielino dritta: 7.1  
Straight bracket for canopy front: 7.1



Cielini  
Shelf Heads

7.10

Fascia cielino stondata  
Rounded canopy front

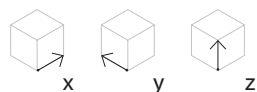
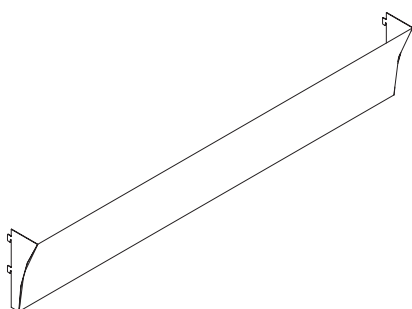

x	y	z	codice code	note notes
50	--	20	20.481	
66,5	--	20	20.482	
75	--	20	20.483	
100	--	20	20.484	
133	--	20	20.485	

finitura finish	colori colours
V	2004
	6018
	6027
	• 7035
	AMA
	• ANT
	AZZ
	1001
	• BIA
	BLU
	GIA
	MAR
	• MTZ
	• PAN
	RO3
	BIMCL
	NRMCL
	• OXI



Cielini  
Shelf Heads

7.11

Fascia cielino stondata con foro per diffusore  
*Rounded canopy front with hole for speaker*

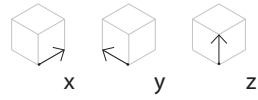
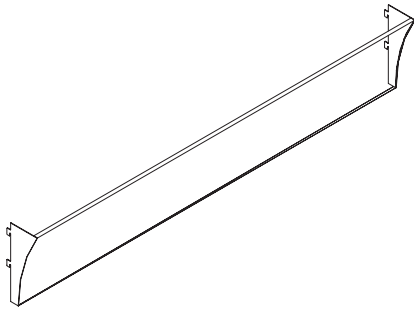

	x	y	z	codice code	note notes
	50	--	20	20.468	
	66,5	--	20	20.467	
	75	--	20	20.466	
	100	--	20	20.395	
	133	--	20	20.465	

finitura finish	colori colours
V	
	2004
	6018
	6027
	• 7035
	AMA
	• ANT
	AZZ
	1001
	• BIA
	BLU
	GIA
	MAR
	• MTZ
	• PAN
	RO3
	BIMCL
	NRMCL
	• OXI



Cielini  
Shelf Heads

7.12

Coperchio cielino per fascia stondata  
*Top cover for rounded canopy front*

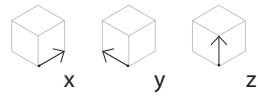
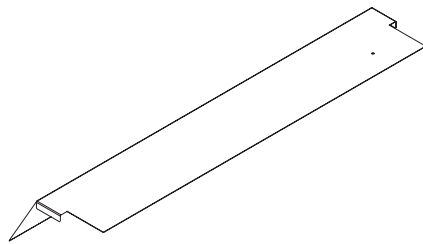

	x	y	z	codice code	note notes
	50	14	14	14.140	
	66,5	14	14	14.141	
	75	14	14	14.142	
	100	14	14	14.101	
	133	14	14	14.143	

finitura finish	colori colours
V	
	2004
	6018
	6027
	• 7035
	AMA
	• ANT
	AZZ
	1001
	• BIA
	BLU
	GIA
	MAR
	• MTZ
	• PAN
	RO3
	BIMCL
	NRMCL
	• OXI



Cielini  
Shelf Heads

7.13

Perspex per chiusura frontale fascia stondata con foro  
*Perspex for rounded canopy front with hole for speaker*

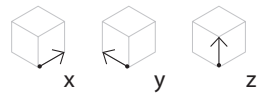
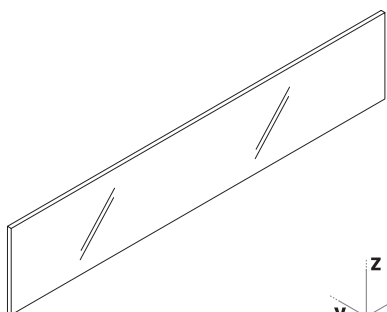

	x	y	z	codice code	finitura e colore finish & colour	note notes
	50	--	20	20.486	TTRA	
	66,5	--	20	20.487	TTRA	
	75	--	20	20.488	TTRA	
	100	--	20	20.489	TTRA	
	133	--	20	20.490	TTRA	





7.14

### Pannello di chiusura per fascia stondata

Top closing panel for rounded canopy front

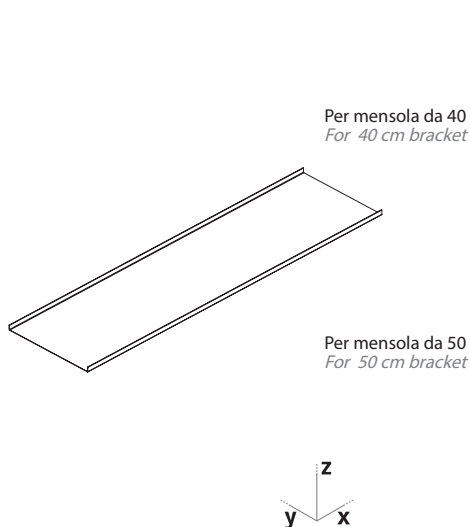

x	y	z	codice code	note notes
50	18	--	13.247	
66,5	18	--	13.249	
75	18	--	13.246	
100	18	--	13.245	
133	18	--	13.248	
50	29	--	13.-07	
66,5	29	--	13.149	
75	29	--	13.-06	
100	29	--	13.-05	
133	29	--	13.-08	

finitura finish	colori colours
P	V
	2004
	6018
	6027
•	7035
	AMA
	• ANT
	AZZ
	1001
•	BIA
	BLU
	GIA
	MAR
	• MTZ
•	PAN
	RO3
	BIMCL
	NRMCL
	• OXI



7.15

### Plafoniera con schermo protettivo \*

Protected canopy light fixture \*

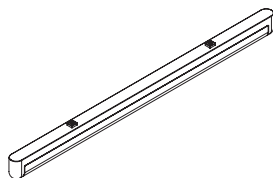

x	y	z	codice code	finitura e colore finish & colour	note notes
45	--	--	20.103	T BIA	
95	--	--	20.-96	T BIA	
125	--	--	20.104	T BIA	

### Supporto plafoniera per piani a liste

Canopy light fixture support for plank shelf

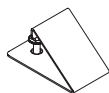

x	y	z	codice code	finitura e colore finish & colour	note notes
3	5,5	3,5	34.-18	P PAN	

### Supporto plafoniera per piani interi

Canopy light fixture support for one piece shelf



x	y	z	codice code	finitura e colore finish & colour	note notes
--	--	--	34.222	C	

\* Cablaggio non incluso

\* Cables not included



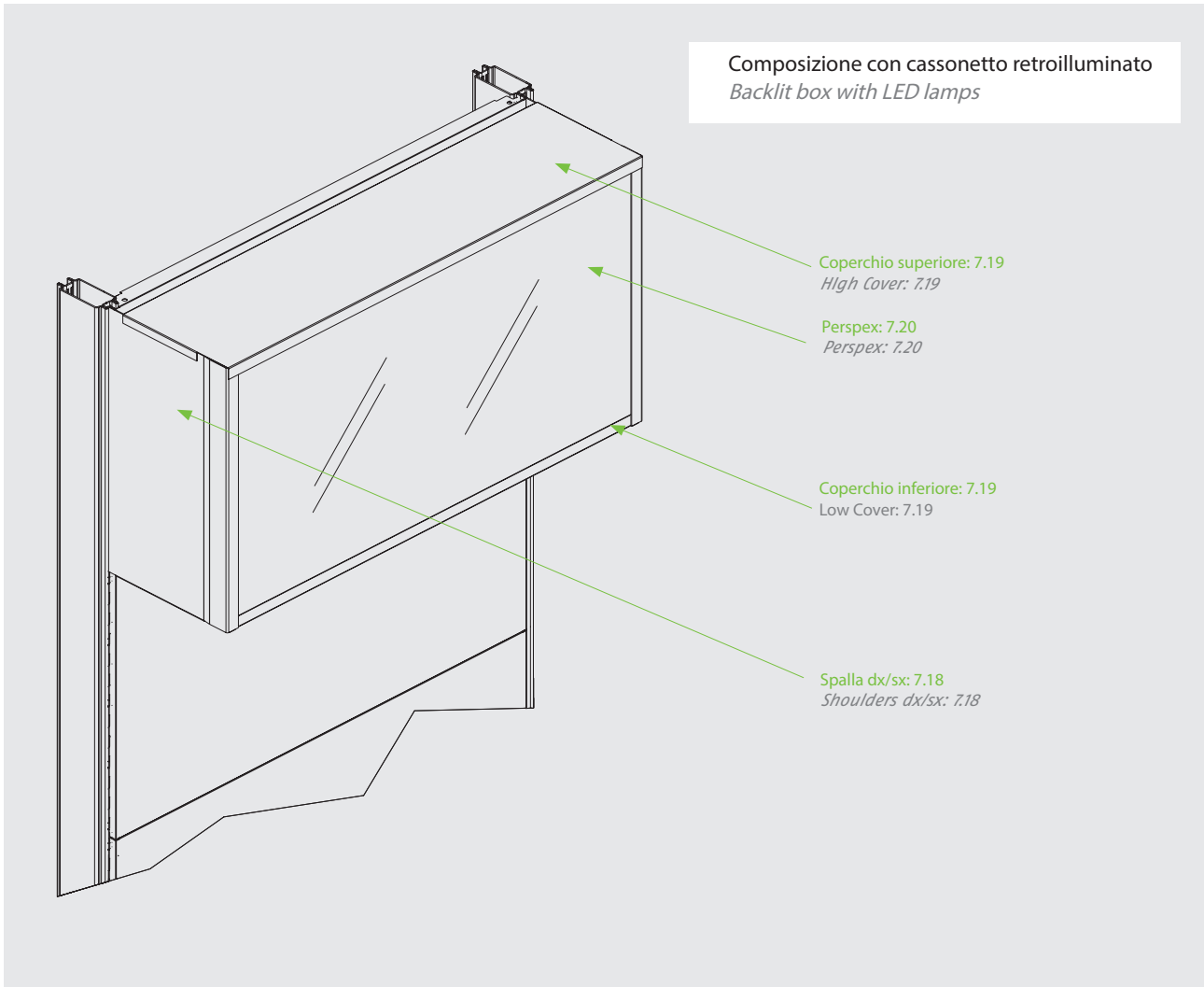

**7.18** Spalle per cassonetto retroilluminato  
*Shoulders for backlit box*



Cielini  
*Shelf Heads*

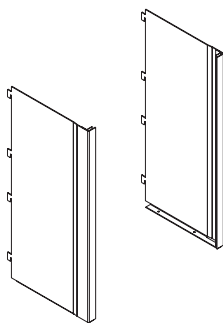

	x	y	z	codice code	note notes
dx rh	100	20	47	20.505	
sx lh	100	20	47	20.506	

LED: 7.24  
LED: 7.24

finitura finish	colori colours
V	2004
	6018
	6027
	• 7035
	AMA
	• ANT
	AZZ
	1001
	• BIA
	BLU
	GIA
	MAR
	• MTZ
	• PAN
	RO3
	BIMCL
	NRMCL
	• OXI



Cielini  
Shelf Heads

7.19

Coperchi ciechi per cassonetto retroilluminato  
Cover for backlit box

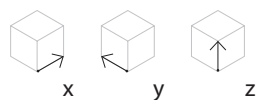
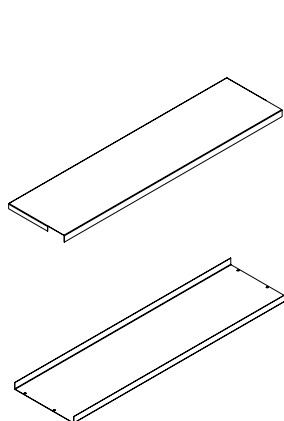

	x	y	z	codice code	note notes
Superiore Top	100	20	--	20.507	
Inferiore Low	100	20	--	20.508	

finitura finish	colori colours
V	2004
	6018
	6027
	• 7035
	• AMA
	• ANT
	AZZ
	1001
	• BIA
	BLU
	GIA
	MAR
	• MTZ
	• PAN
	RO3
	BIMCL
	NRMCL
	MRMCL
	• OXI



Cielini  
Shelf Heads

7.20

Perspex per chiusura frontale cassonetto retroilluminato  
Perspex for front closing of backlit box

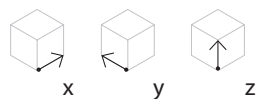
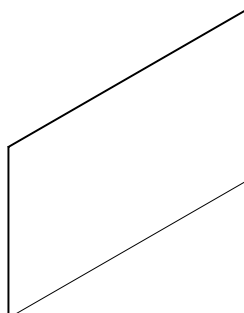

x	y	z	codice code	finitura e colore finish & colour	note notes
100	3	45	20.510	TTRA	

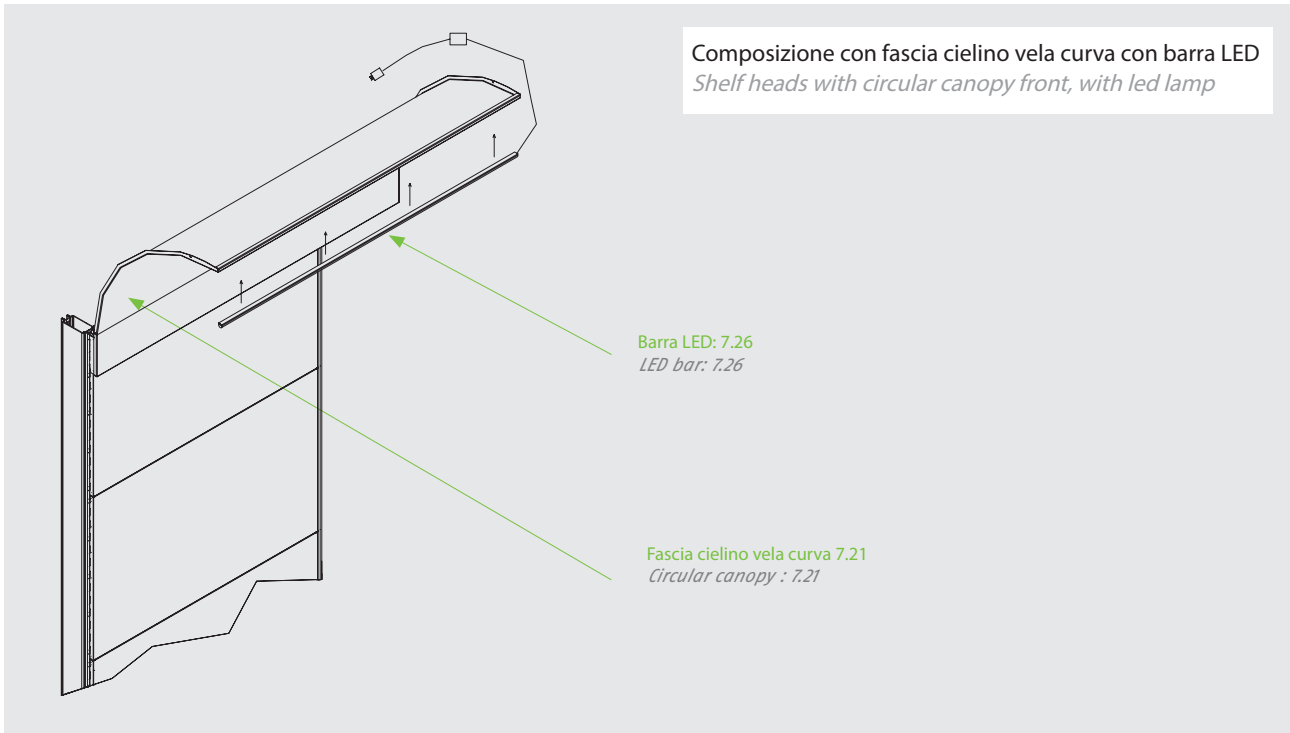

**Cielini Shelf Heads** **7.21** Cielino vela curvo h 55 cm  
Circular canopy h 55 cm

x	y	z	codice code	note notes
50	--	55	13.619	
75	--	55	13.589	
100	--	55	13.574	

finitura finish	colori colours
V	2004
	6018
	6027
•	7035
	AMA
•	ANT
	AZZ
	1001
•	BIA
	BLU
	GIA
	MAR
•	MTZ
•	PAN
	RO3
	BIMCL
	NRMCL
•	OXI

**Cielini Shelf Heads** **7.21** Cielino vela curvo h 55 cm  
Circular canopy h 55 cm

x	y	z	codice code	note notes
50	0,2	40	37.200	
66,5	0,2	40	37.201	
100	0,2	40	37.203	
133	0,2	40	37.204	

finitura finish	colori colours
S	• BRAND

Cielini  
Shelf Heads

7.26

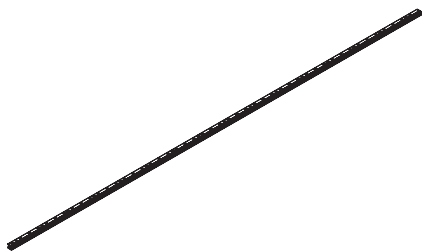
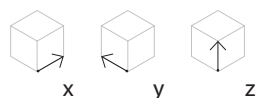
Illuminazione con barre a Led con magnete  
*Led bar lighting with magnet*orientabile  
adjustable  
orientabile  
adjustable

	x	y	z	codice code	finitura e colore finish & colour	note notes
	48	--	--	20.458	LED	7 W - 12 V
	64	--	--	20.459	LED	9 W - 12 V
	98	--	--	20.460	LED	14,4 W - 12 V
	130	--	--	20.461	LED	19 W - 12 V
orientabile adjustable	98	--	--	20.475	LEDC	14,4 W - 12 V
orientabile adjustable	130	--	--	20.473	LEDC	19 W - 12 V

Ferma cavo con magnete  
*Magnetic wire stopper*

codice code	note notes
34.665	

Cielini  
Shelf Heads

7.27

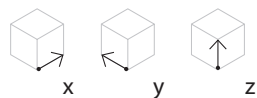
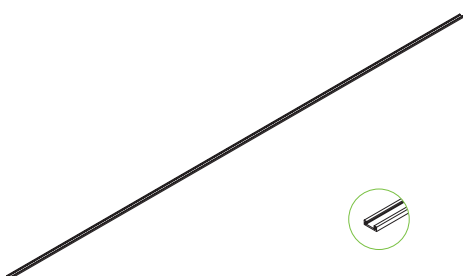
Binario elettrificato a bassissima tensione con magneti per luci a led  
*Extra- low voltage electrified track with magnets for led lamps*

	x	y	z	codice code	finitura e colore finish & colour	note notes
	--	--	200	20.462	LED	
	--	--	140	20.463	LED	

Cielini  
Shelf Heads

7.28

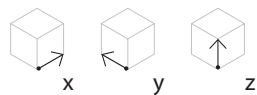
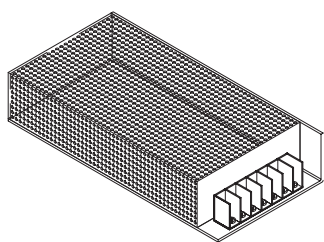
Trasformatore per binario elettrificato per luci a led  
*Switching power supply for led lamps*



	x	y	z	codice code	finitura e colore finish & colour	note notes
	--	--	--	20.464		35 W - 12 V + connettore
	--	--	--	20.404		150 W - 12 V + connet-



7.29

illuminazione con barre a Led con magnete e jack  
*LED bar lighting with magnet and jack cable*



	 x	 y	 z	codice code	finitura e colore finish & colour	note notes
	48	--	--	20.512	LED	7 W - 12 V
	64	--	--	20.513	LED	9 W - 12 V
	98	--	--	20.514	LED	14,4 W - 12 V
	130	--	--	20.515	LED	19 W - 12 V

Ferma cavo con magnete  
Magnetic wire stopper



codice code	note notes
34.665	

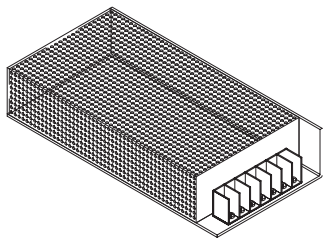

7.30

Trasformatore per singolo led  
*Switching power supply for single led*



	 x	 y	 z	codice code	finitura e colore finish & colour	note notes
	--	--	--	20.469		30 W - 12 V + jack

Cielini  
Shelf Heads

7.31

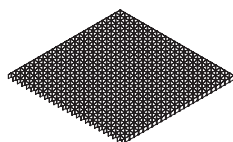
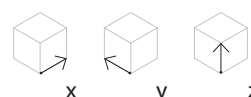
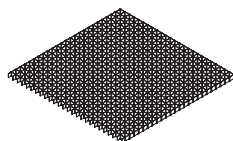
Grigliato di chiusura cielino  
*Canopy light diffuser*mensola dritta  
*straight bracket*mensola inclinata  
*angled bracket*

	x	y	z	codice code	finitura e colore finish & colour	note notes
passo 50 bay 50	24,5	50,5	2	30.127	T BIA	
	24,5	60	2	30.128	T BIA	
passo 66,5 bay 66,5	32,5	50,5	2	30.130	T BIA	
	32,5	60	2	30.131	T BIA	
passo 75 bay 75	37	50,5	2	30.124	T BIA	
	37	60	2	30.125	T BIA	
passo 100 bay 100	49,5	50,5	2	30.121	T BIA	
	49,5	60	2	30.119	T BIA	
passo 133 bay 133	66	50,5	2	30.133	T BIA	
	66	60	2	30.134	T BIA	
passo 50 bay 50	24,5	47,5	2	30.142	T BIA	
	24,5	57	2	30.143	T BIA	
passo 66,5 bay 66,5	32,5	47,5	2	30.145	T BIA	
	32,5	57	2	30.146	T BIA	
passo 75 bay 75	37	47,5	2	30.139	T BIA	
	37	57	2	30.140	T BIA	
passo 100 bay 100	49,5	47,5	2	30.136	T BIA	
	49,5	57	2	30.137	T BIA	
passo 133 bay 133	66	47,5	2	30.148	T BIA	
	66	57	2	30.149	T BIA	

Cielini  
Shelf Heads

7.32

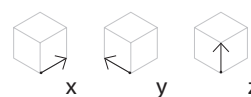
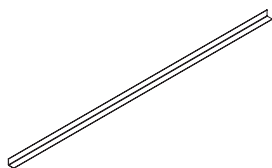
Traverso di supporto per il grigliato  
*Crosspiece to support canopy light diffuser*

	x	y	z	codice code	finitura e colore finish & colour	note notes
	50	2	2	30.-95	P BIA	
	66,5	2	2	30.111	P BIA	
	75	2	2	30.-94	P BIA	
	100	2	2	30.-93	P BIA	
	133	2	2	30.-92	P BIA	

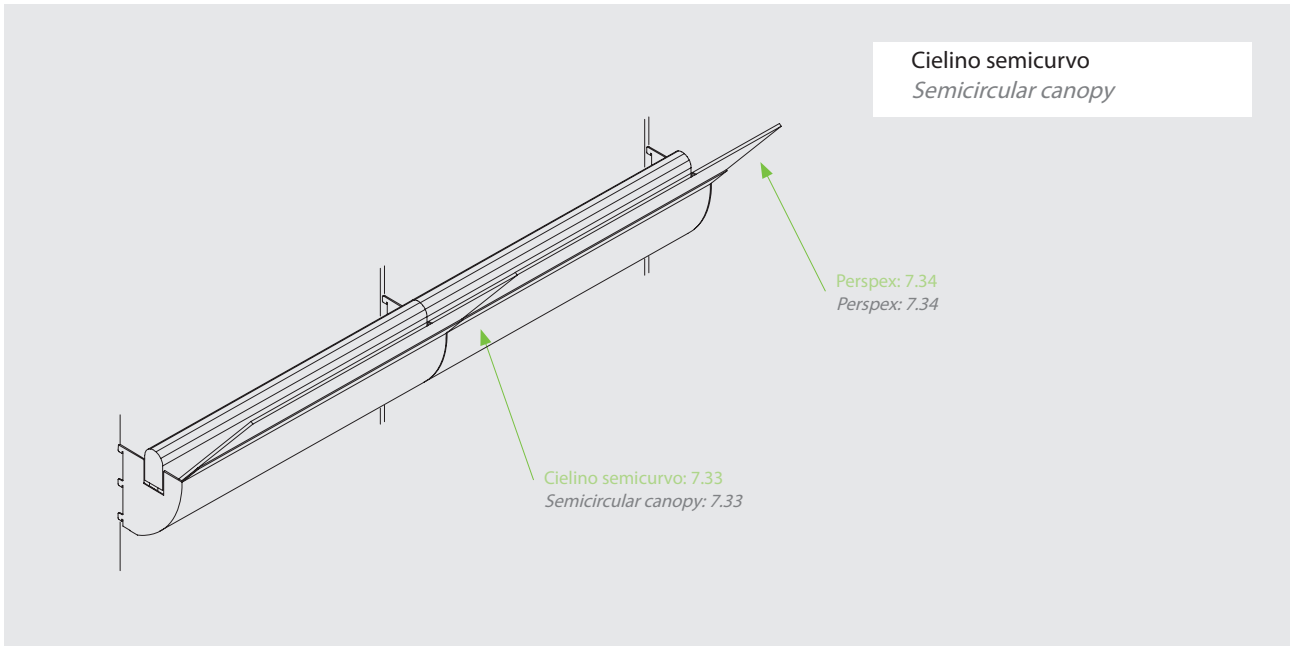

**Cielini Shelf Heads** **7.33** Cielino semicurvo Semicircular canopy

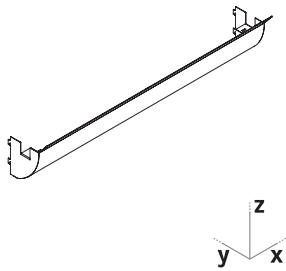

x	y	z	codice code	note notes
50	15	18	20.281	
75	15	18	20.243	
100	15	18	20.242	

finitura finish	colori colours
V	2004
	6018
	6027
	• 7035
	AMA
	• ANT
	AZZ
	1001
	• BIA
	BLU
	GIA
	MAR
	• MTZ
	• PAN
	RO3
	BIMCL
	NRMCL
	• OXI

**Cielini Shelf Heads** **7.34** Perspex per cielino semicurvo Perspex for semicircular canopy

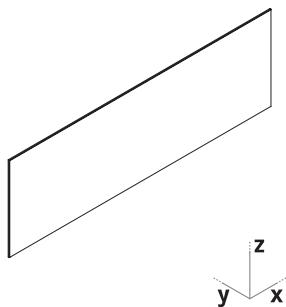

x	y	z	codice code	finitura e colore finish & colour	note notes
49,3	0,5	23	20.314	T BIA	
74,3	0,5	23	20.247	T BIA	
97,3	0,5	23	20.246	T BIA	



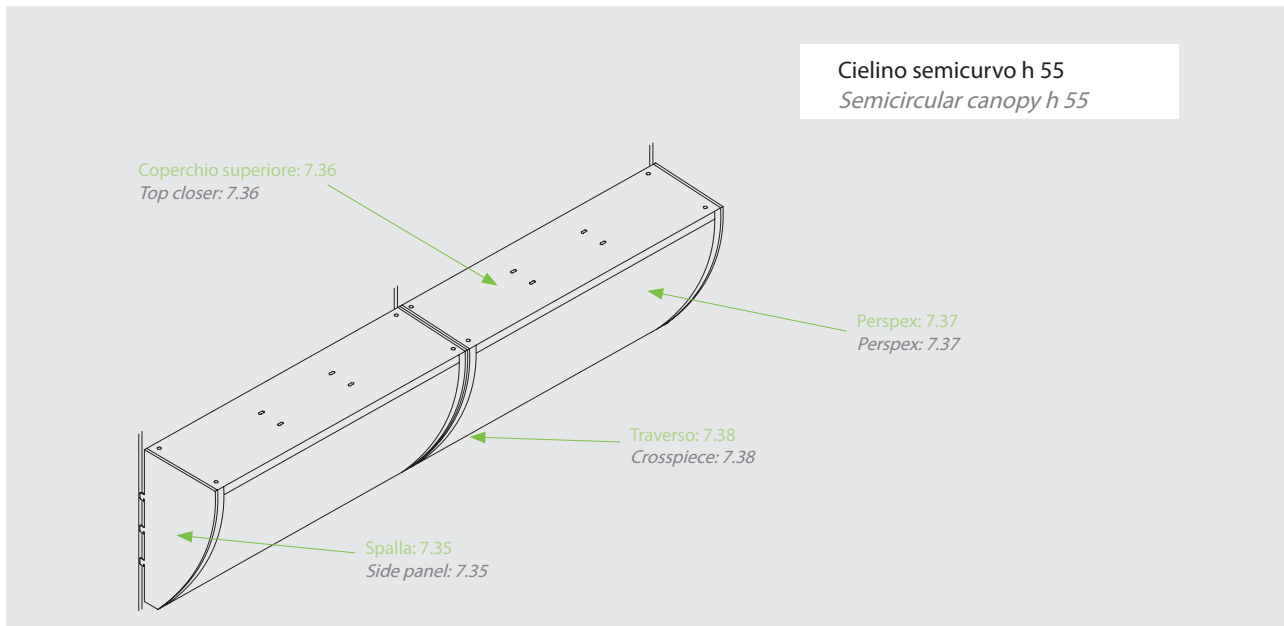

**Cielini Shelf Heads** **7.35** Spalla per cielino semicurvo h 55  
Side panel for semicircular canopy h 55

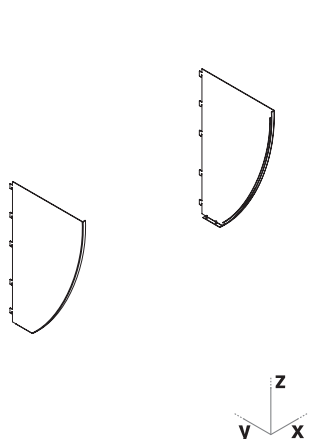

	x	y	z	codice code	note notes
dx rh	--	28	55	16.316	
sx lh	--	28	55	16.317	

finitura finish	colori colours
V	2004
	6018
	6027
	• 7035
	AMA
	• ANT
	AZZ
	1001
	• BIA
	BLU
	GIA
	MAR
	• MTZ
	• PAN
	RO3
	BIMCL
	NRMCL
	• OXI

**Cielini Shelf Heads** **7.36** Coperchio superiore per cielino semicurvo h 55  
Top closer for semicircular canopy h 55

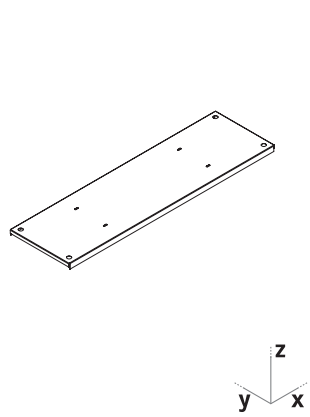

	x	y	z	codice code	note notes
	100	28	--	20.250	

finitura finish	colori colours
V	2004
	6018
	6027
	• 7035
	AMA
	• ANT
	AZZ
	1001
	• BIA
	BLU
	GIA
	MAR
	• MTZ
	• PAN
	RO3
	BIMCL
	NRMCL
	• OXI

**Cielini Shelf Heads** **7.37** Perspex per cielino semicurvo h 55  
*Perspex for semicircular canopy h 55*

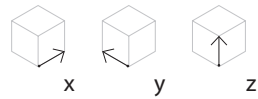
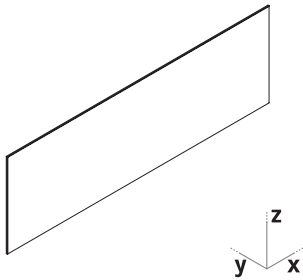

x	y	z	codice code	finitura e colore finish & colour	note notes
100	0,3	60	20.248	T BIA	

**Cielini Shelf Heads** **7.38** Traverso per cielino semicurvo h 55  
*Crosspiece for semicircular canopy h 55*

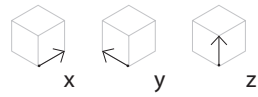
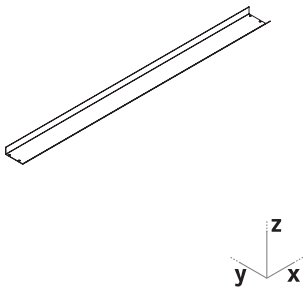

x	y	z	codice code	note notes
100	8	--	20.249	

finitura finish	colori colours
V	
	2004
	6018
	6027
	• 7035
	AMA
	• ANT
	AZZ
	1001
	• BIA
	BLU
	GIA
	MAR
	• MTZ
	• PAN
	RO3
	BIMCL
	NRMCL
	• OXI

**Composizione con specchio**  
*Setting with mirror*

n°2 Traversi di collegamento: 7.40  
n°2 Tubular crosspieces: 7.40

Specchio ortofrutta: 7.42  
Mirror for fruit & vegetables areas: 7.42



Mensola inclinabile: 7.39  
Flying bracket: 7.39

Cielini  
Shelf Heads

7.39

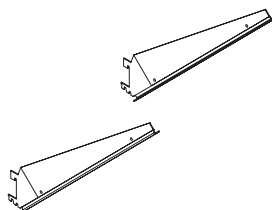
Mensola inclinabile per specchio e pannello  
didattico  
*Flying braket for mirror and information  
panel*



	 x	 y	 z	codice code	finitura e colore finish & colour	note notes
dx rh	--	--	57	16.-23	C	
sn lh	--	--	57	16.-22	C	



Specchio e pannello  
didattico: 7.41 / 7.42  
*Mirror and information  
panel: 7.41 / 7.42*

Cielini  
Shelf Heads

7.40

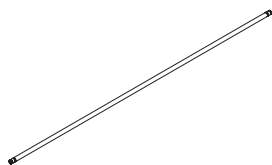
Traverso di collegamento in tubo  $\varnothing$  1,2 con viti  
*Tubular crosspiece  $\varnothing$  1,2 with screws*







	 x	 y	 z	codice code	finitura e colore finish & colour	note notes
50	--	--	--	34.-24	C	
66,5	--	--	--	34.234	C	
75	--	--	--	34.-23	C	
100	--	--	--	34.-22	C	
133	--	--	--	34.120	C	

Cielini  
Shelf Heads

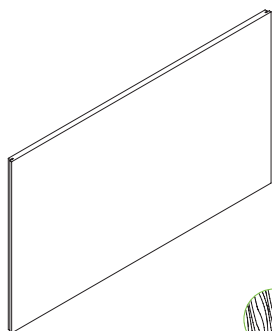
7.41

Pannello didattico in nobilitato  
*Wooden information panel*



	 x	 y	 z	codice code	note notes	finitura finish	colori colours
50	--	--	60	34.513		T	
66,5	--	--	60	34.517		•	7035
75	--	--	60	34.415		•	BIA
100	--	--	60	34.414		•	MTZ
133	--	--	60	34.516		•	PAN
							SBI
50	--	--	90	34.514			
66,5	--	--	90	34.515			
75	--	--	90	34.417			
100	--	--	90	34.416			
133	--	--	90	34.512			



7.42

Specchio ortofrutta  
Mirror for fruit & vegetable areas

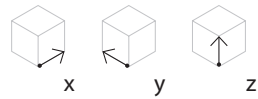
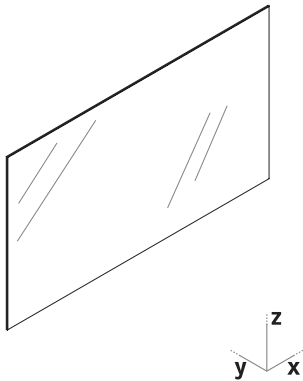

	x	y	z	codice code	finitura e colore finish & colour	note notes
	50	--	57	31.-08	NP	
	66,5	--	57	31.-18	NP	
	75	--	57	31.-07	NP	
	100	--	57	31.-06	NP	

Composizione con spalle inclinate e doghe  
Setting with side panels and slats

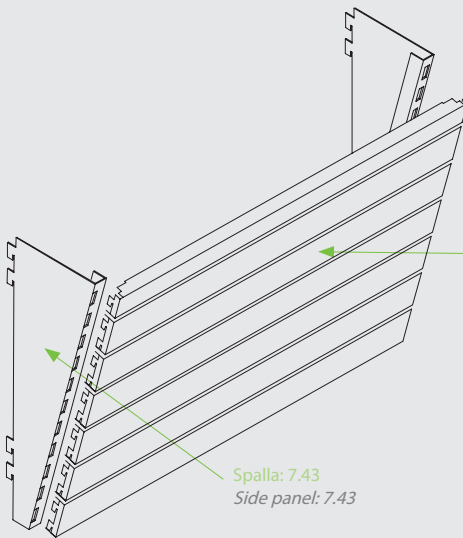

Doghe portanti (n.1 x 3,6 e n.6 x 7,2):  
3.18 / 3.19  
Load bearing slats (n.1 x 3,6 and n.6 x 7,2):  
3.18 / 3.19

Spalla: 7.43  
Side panel: 7.43



7.43

Spalla h 47 per pannello didattico  
Side panel for information panel

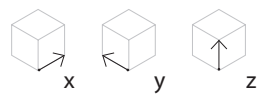
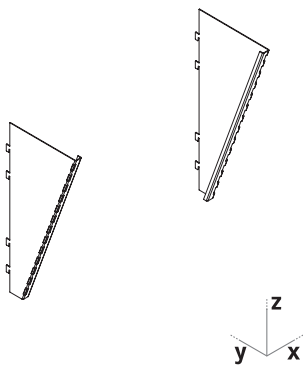

	x	y	z	codice code	note notes
dx rh	--	--	47	34.413	
sx lh	--	--	47	34.412	

finitura finish	colori colours
V	2004
	6018
	6027
•	7035
	AMA
•	ANT
	AZZ
	1001
•	BIA
	BLU
	GIA
	MAR
•	MTZ
•	PAN
	RO3
	BIMCL
	NRMCL
•	OXI

**note**  
*notes*

**note**  
*notes*

Accessori ed  
espositori

*Accessories and  
displays*

8

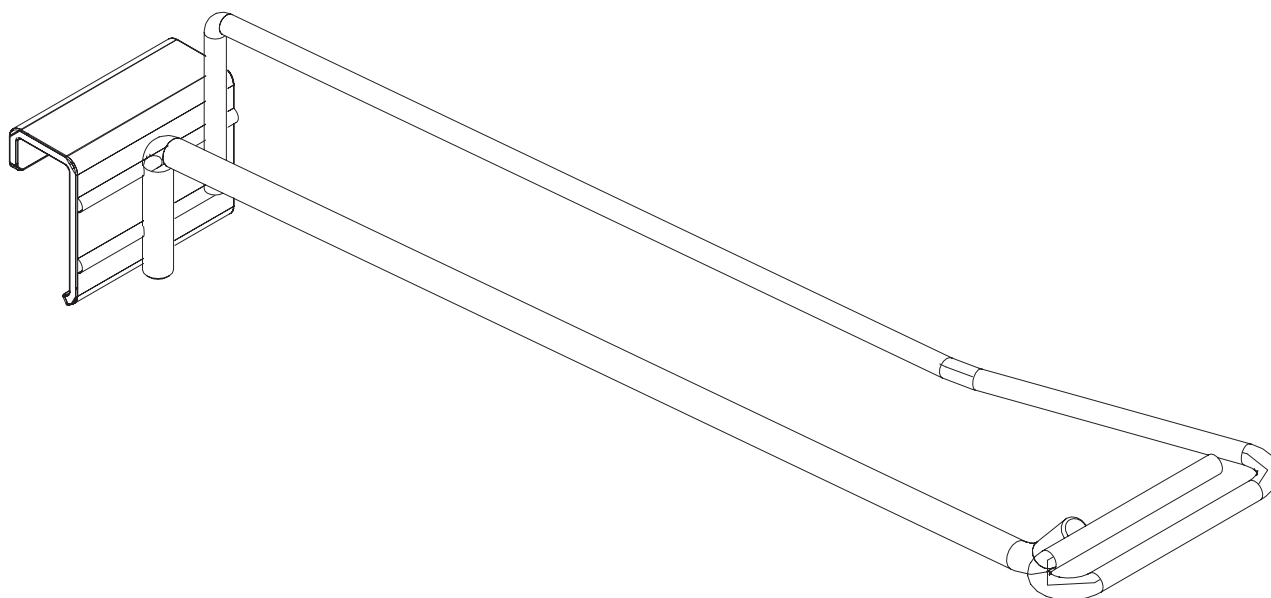

Accessori per fondali forati, asolati e dogati.  
Barra forata, barra liscia, barra ovale e accessori.  
Espositori dedicati ai diversi settori merceologici.

*Accessories for perforated, slotted and slatted panels.  
Bar, perforated bar, oval bar and accessories.  
Particular displays for different product sectors.*





# Accessori per fondali forati e asolati

## *Accessories for perforated and slotted panels*

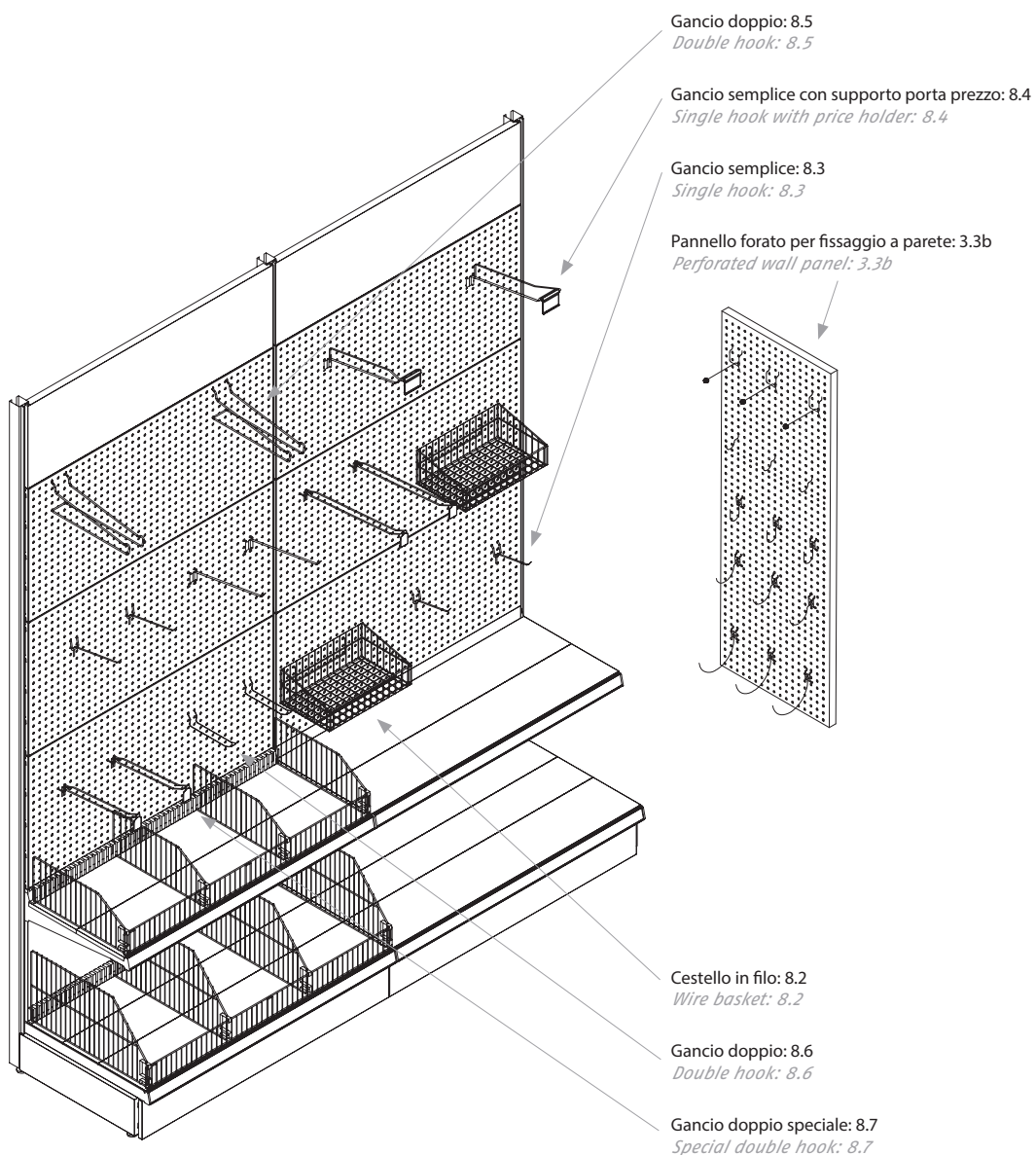

**Accessori**  
Accessories

**8.1** Ganci per pannelli forati (e asolati)  
*Hooks for perforated (and slotted) panels*

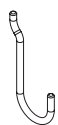
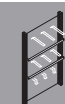

Gancio curvato  
*Curved hook*

codice code  
finitura e colore finish & colour  
24.-04 C



Gancio curva stretta  
*Small curved hook*

34.333 C

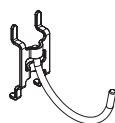

Gancio curva media  
*Medium curved hook*

34.411 C

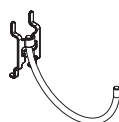

Gancio curva grande  
*Large curved hook*

34.334 C



**Accessori**  
Accessories

**8.2** Cestello in filo per pannelli forati (e asolati)  
*Wire basket for perforated (and slotted) panels*

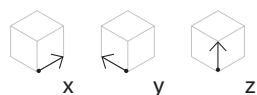
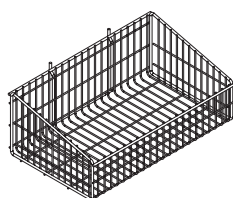

33 20 12 24.-10 finitura e colore finish & colour C note notes



**Accessori**  
Accessories

**8.3** Gancio semplice per pannelli forati (e asolati)  
*Single hook for perforated (and slotted) panels*

→ Utilizzare con protezione in PVC: 8.33 Use with PVC cap: 8.33

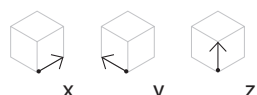
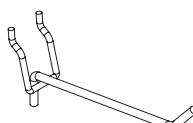

-- 15 -- 24.-05 finitura e colore finish & colour C note notes

-- 20 -- 24.-06 C

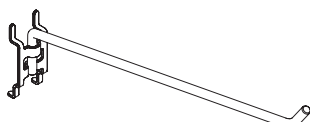

-- 30 -- 24.-07 C





Accessori  
Accessories

8.4

Gancio semplice con supporto porta prezzo per pannelli forati (e asolati)  
*Single hook with price holder for perforated (and slotted) panels*

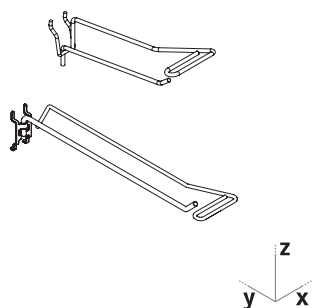

x	y	z	codice code	finitura e colore finish & colour	note notes
--	20	--	35.106	C	
--	30	--	35.-45	C	
--	35	--	35.107	C	



Accessori  
Accessories

8.5

Gancio doppio per pannelli forati (e asolati)  
*Double hook for perforated (and slotted) panels*

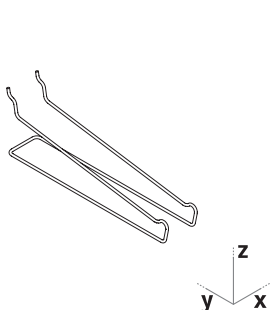

x	y	z	codice code	finitura e colore finish & colour	note notes
6,7	30	--	24.-08	C	



Accessori  
Accessories

8.6

Gancio doppio per pannelli forati (e asolati)  
*Double hook for perforated (and slotted) panels*

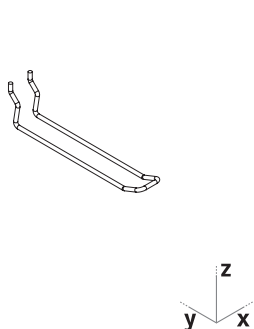

x	y	z	codice code	finitura e colore finish & colour	note notes
2,8	17	--	24.-13	C	



Accessori  
Accessories

8.7

Gancio doppio speciale per pannelli forati (e asolati)  
*Special double hook for perforated (and slotted) panels*

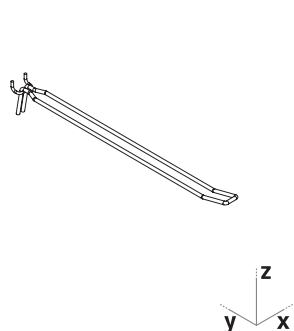

x	y	z	codice code	finitura e colore finish & colour	note notes
2,5	30	--	35.115	C	
2,5	40	--	35.116	C	



Accessori  
Accessories

8.8

Gancio zincato con sfera di protezione anteriore per pannelli forati (e asolati)  
*Hook with safety protection for perforated (and slotted) panels*

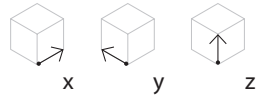
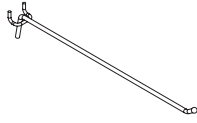

	x	y	z	codice code	finitura e colore finish & colour	note notes
	--	8	--	35.155	C	
	--	12	--	35.156	C	
	--	16	--	35.157	C	
	--	20	--	35.158	C	
	--	30	--	35.159	C	



Accessori  
Accessories

8.9

Gancio doppio per pannello forato / per pinze o simili  
*Double hook for perforated panels / for pliers and similar*

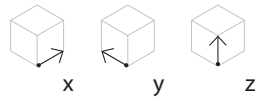
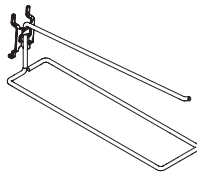

	x	y	z	codice code	finitura e colore finish & colour	note notes
	--	30	--	24.-32	C	



Accessori  
Accessories

8.10

Gancio semplice con supporto porta prezzo per pannelli asolati  
*Single hook with price holder for slotted panels*

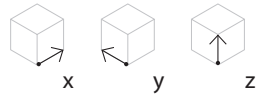
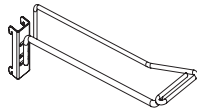

	x	y	z	codice code	finitura e colore finish & colour	note notes
	--	20	--	35.167	C	
	--	30	--	35.168	C	



Accessori  
Accessories

8.11

Gancio per pannello asolato / per cazzuole o simili  
*Bar for slotted panels / for trowels and similar*

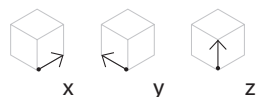
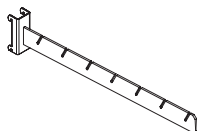

	x	y	z	codice code	finitura e colore finish & colour	note notes
	--	35	3	35.162	C	



Accessori  
Accessories

8.12

Gancio per pannello asolato / per badili, rastrelli o simili  
Bar for slotted panels / for shovels and similar

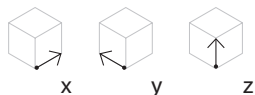
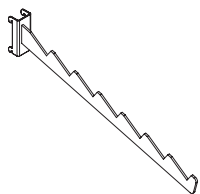

x	y	z	codice code	finitura e colore finish & colour	note notes
--	35	--	35.163	C	



Accessori  
Accessories

8.13

Gancio per pannello asolato / per martelli o simili  
Bar for slotted panels / for hammers and similar

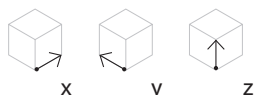
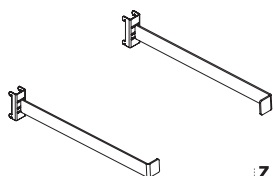

	x	y	z	codice code	finitura e colore finish & colour	note notes
dx rh	3	35	3	35.164	C	
sx lh	3	35	3	35.165	C	

Accessori per pannello asolato  
Accessories for slotted panels

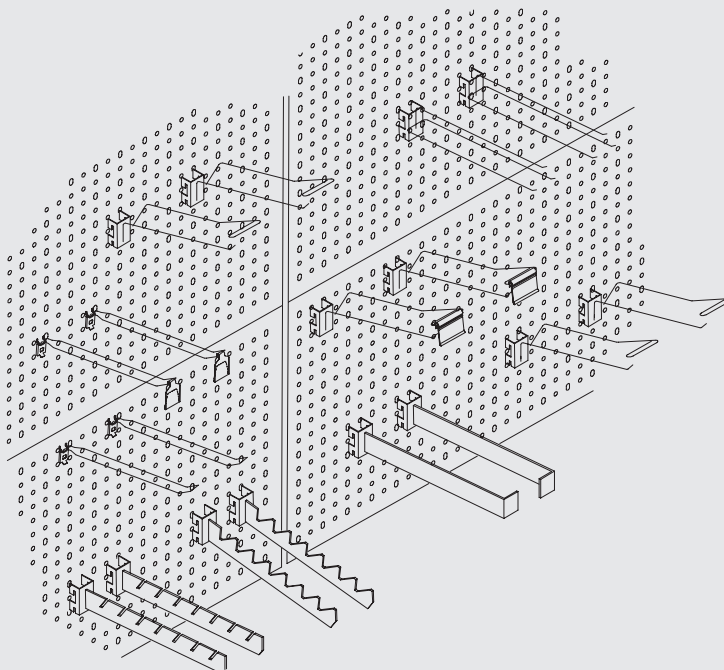

# Accessori per fondali a doghe

## Accessories for slatted panels

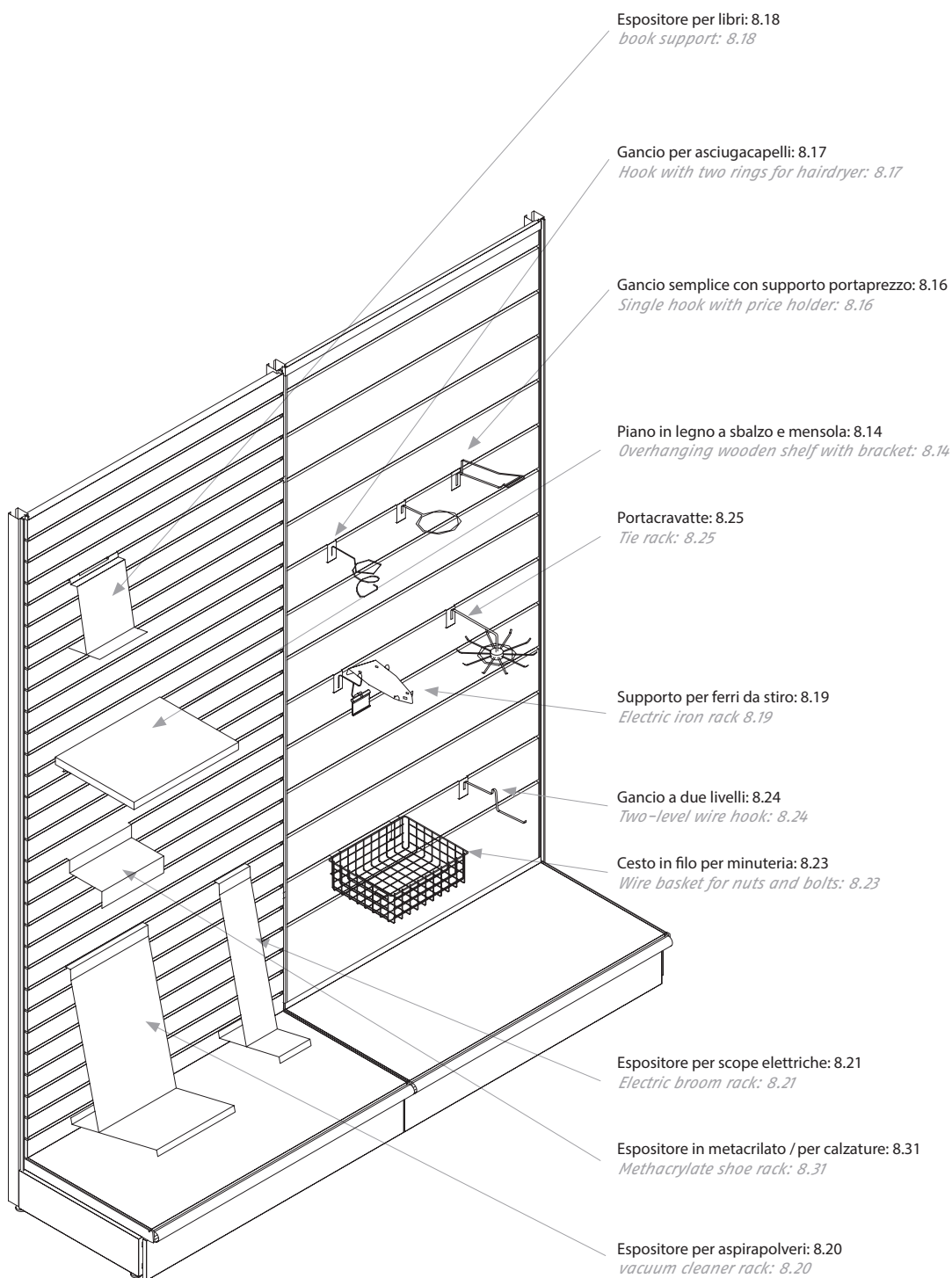



Accessori  
Accessories

8.14

Mensola per piano a sbalzo in legno per fondali a doghe  
*Bracket for overhanging wooden shelf for slatted panels*

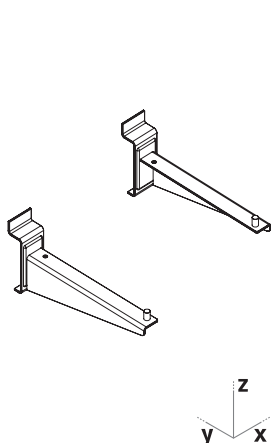

	x	y	z	codice code	note notes
dx rh	--	20	--	16.246	
sx lh	--	20	--	16.247	

finitura finish	colori colours
<b>C</b>	<b>V</b>
	2004
	6018
	6027
	7035
	AMA
	ANT
	AZZ
	1001
	BIA
	BLU
	GIA
	MAR
	MTZ
	PAN
	RO3
	BIMCL
	NRMCL
	OXI
•	---

Piano a sbalzo in legno

*Overhanging wooden shelf*

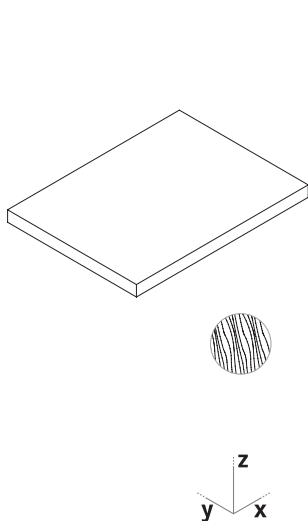

	x	y	z	codice code	note notes
	40	30	2,5	17.413	

finitura finish	colori colours
<b>T</b>	
•	7035
•	ACE
•	BIA
	FAG
•	MTZ
•	PAN
•	A439
•	ANT
	K101
	3813
	2293
	990XA
	990XM
	A838
	999XA
	995XM
	989XR
	994XS
	997XS
	983XR
	BLACK
	GREEN
	BEIGE
	WHITE









Accessori  
Accessories

8.21

Espositore per scope elettriche per fondali a doghe  
*Electric broom rack for slatted panels*

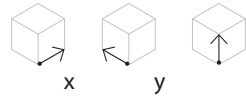
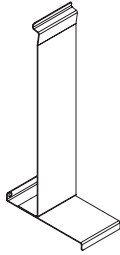

x y z

codice  
code

note  
notes

x	y	z	codice code	note notes
12	13	51	34.373	

finitura  
finish

colori  
colours

finitura finish	colori colours
V	2004
	6018
	6027
	• 7035
	AMA
	• ANT
	AZZ
	1001
	• BIA
	BLU
	GIA
	MAR
	• MTZ
	• PAN
	RO3
	BIMCL
	NRMCL
	• OXI



Accessori  
Accessories

8.22

Supporto per tubo aspirapolveri per fondali a doghe  
*Vacuum cleaner hose support for slatted panels*

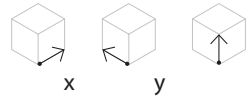
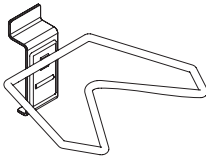

x y z

codice  
code

finitura e  
colore  
finish &  
colour

note  
notes

x	y	z	codice code	finitura e colore finish & colour	note notes
7,5	15	--	34.405	C	



Accessori  
Accessories

8.23

Cesto in filo per minuteria per fondali a doghe  
*Wire basket for nuts and bolts for slatted panels*

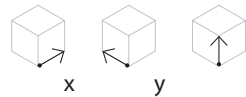
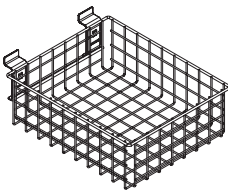

x y z

codice  
code

finitura e  
colore  
finish &  
colour

note  
notes

x	y	z	codice code	finitura e colore finish & colour	note notes
25	30	10	25.-89	C	
25	40	10	25.-90	C	





Accessori  
Accessories

8.27

Tubo ovale dritto per fondali a doghe  
*Oval tubular bar for slatted panels*

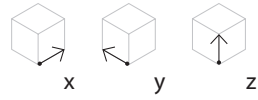
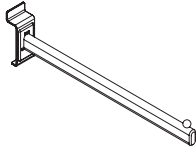

x	y	z	codice code
--	35	--	23.302

note notes

finitura finish

colori colours

colori colours

C	V	colori colours
•	---	MAR
	2004	MTZ
	6018	PAN
	6027	RO3
	7035	BIMCL
	AMA	NRMCL
	ANT	OXI
	AZZ	
	1001	
	BIA	
	BLU	
	GIA	



Accessori  
Accessories

8.28

Tubo ovale inclinato per fondali a doghe  
*Slanted oval tubular bar for slatted panels*

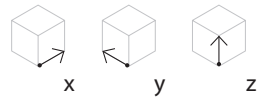
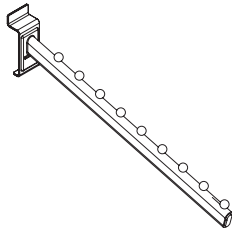

x	y	z	codice code
--	35	--	23.303

note notes

finitura finish

colori colours

colori colours

C	V	colori colours
•	---	MAR
	2004	MTZ
	6018	PAN
	6027	RO3
	7035	BIMCL
	AMA	NRMCL
	ANT	OXI
	AZZ	
	1001	
	BIA	
	BLU	
	GIA	



Accessori  
Accessories

8.29

Tubo ovale a due livelli per fondali a doghe  
*Two-level oval tubular bar for slatted panels*

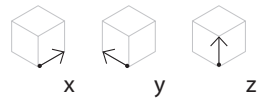
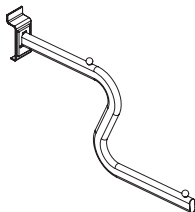

x	y	z	codice code
--	38	19	23.304

note notes

finitura finish

colori colours

colori colours

C	V	colori colours
•	---	MAR
	2004	MTZ
	6018	PAN
	6027	RO3
	7035	BIMCL
	AMA	NRMCL
	ANT	OXI
	AZZ	
	1001	
	BIA	
	BLU	
	GIA	



Barra Ovale  
Oval Bar

8.30

Barra ovale sporgente per fondali a doghe  
Forward oval bar for slatted panels

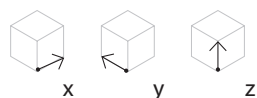
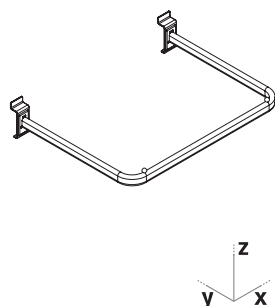

	x	y	z	codice code	note notes
	44	30	--	23.301	

finitura finish	colori colours
C	V
	2004
	6018
	6027
	7035
	AMA
	ANT
	AZZ
	1001
	BIA
	BLU
	GIA
	MAR
	MTZ
	PAN
	RO3
	BIMCL
	NRMCL
	OXI
•	---



Accessori  
Accessories

8.31

Espositore dritto in metacrilato per fondali a doghe  
Methacrylate shoe rack for slatted panel

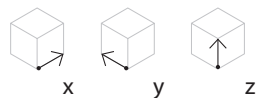
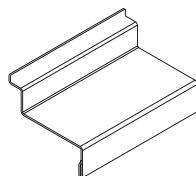

	x	y	z	codice code	finitura e colore finish & colour	note notes
per metallo for metal	24	12	5,6	34.278	T TRA	
per legno for wood	24	12	5,6	34.434	T TRA	



Accessori  
Accessories

8.32

Espositore inclinato per calzature in metacrilato per fondali a doghe  
Methacrylate sloped shoe rack for slatted panel

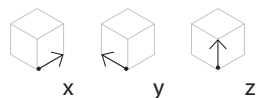
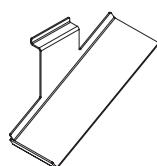







	x	y	z	codice code	finitura e colore finish & colour	note notes
per metallo for metal	32	12	--	34.432	T TRA	
per legno for wood	32	12	--	34.435	T TRA	



Componenti per Accessori  
Elements for Accessories

8.33

Tappo in PVC per protezione gancio  
PVC cap for hooks





				codice code	finitura e colore finish & colour	note notes
	∅ 0,5	--	--	24.-27	T NER	
	∅ 0,6	--	--	24.-28	T NER	
	∅ 0,7	--	--	24.-29	T NER	
	∅ 1	--	--	24.-37	TNER	



Componenti per Accessori  
Elements for Accessories

8.34

Porta prezzo in PVC  
PVC price tag holder

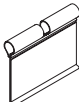
				codice code	finitura e colore finish & colour	note notes
	per ganci doppi for double hooks	2,5	--	5	35.117	T TRA
	per ganci semplici for single hooks	6,5	--	4	35.255	T TRA
	per tappo alettato for finning plugs	6,5	--	4	35.112	T TRA



# Barra forata e accessori

## *Perforated bar and accessories*

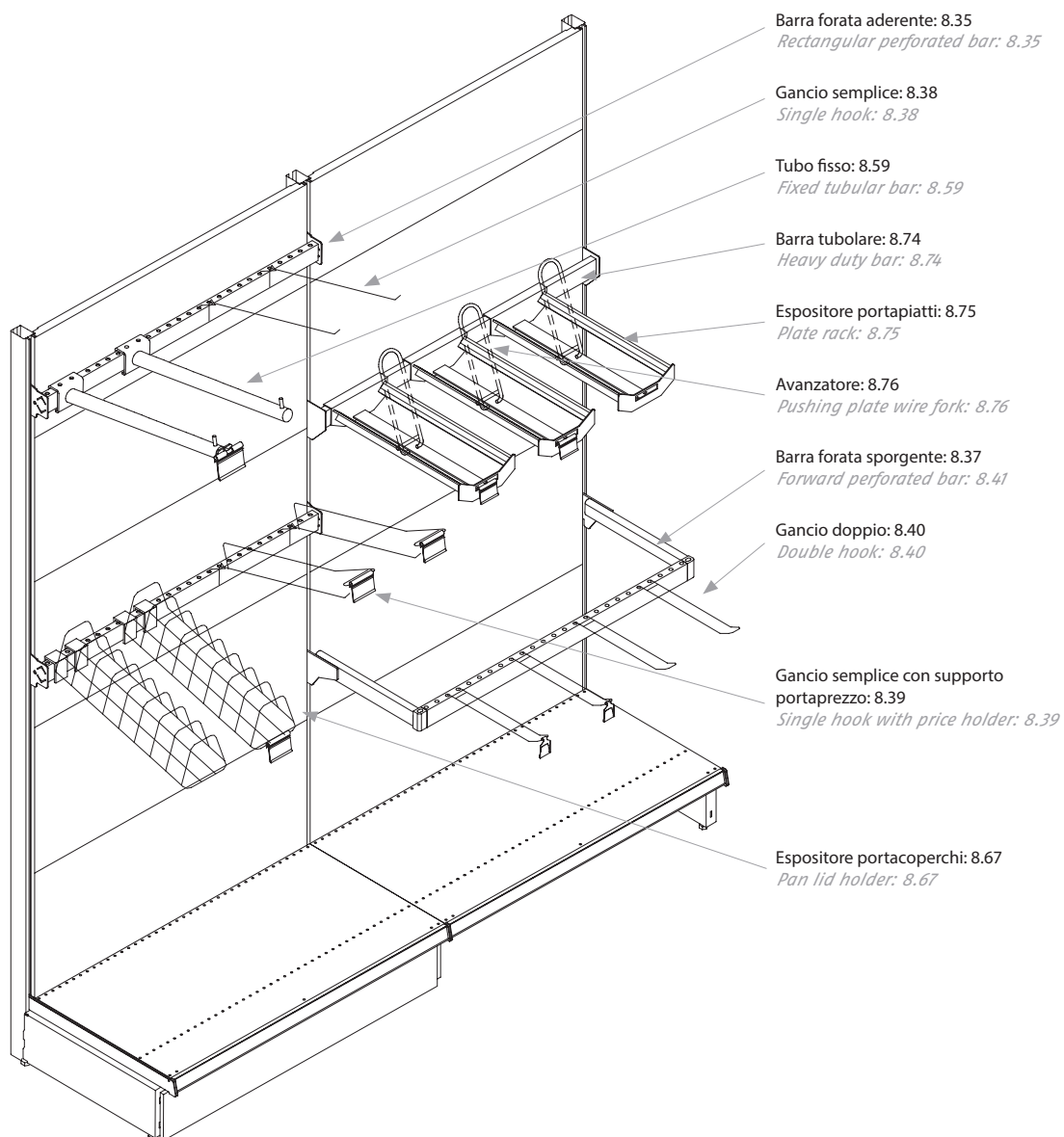

# Barra forata, liscia e accessori

## Rectangular bar and accessories

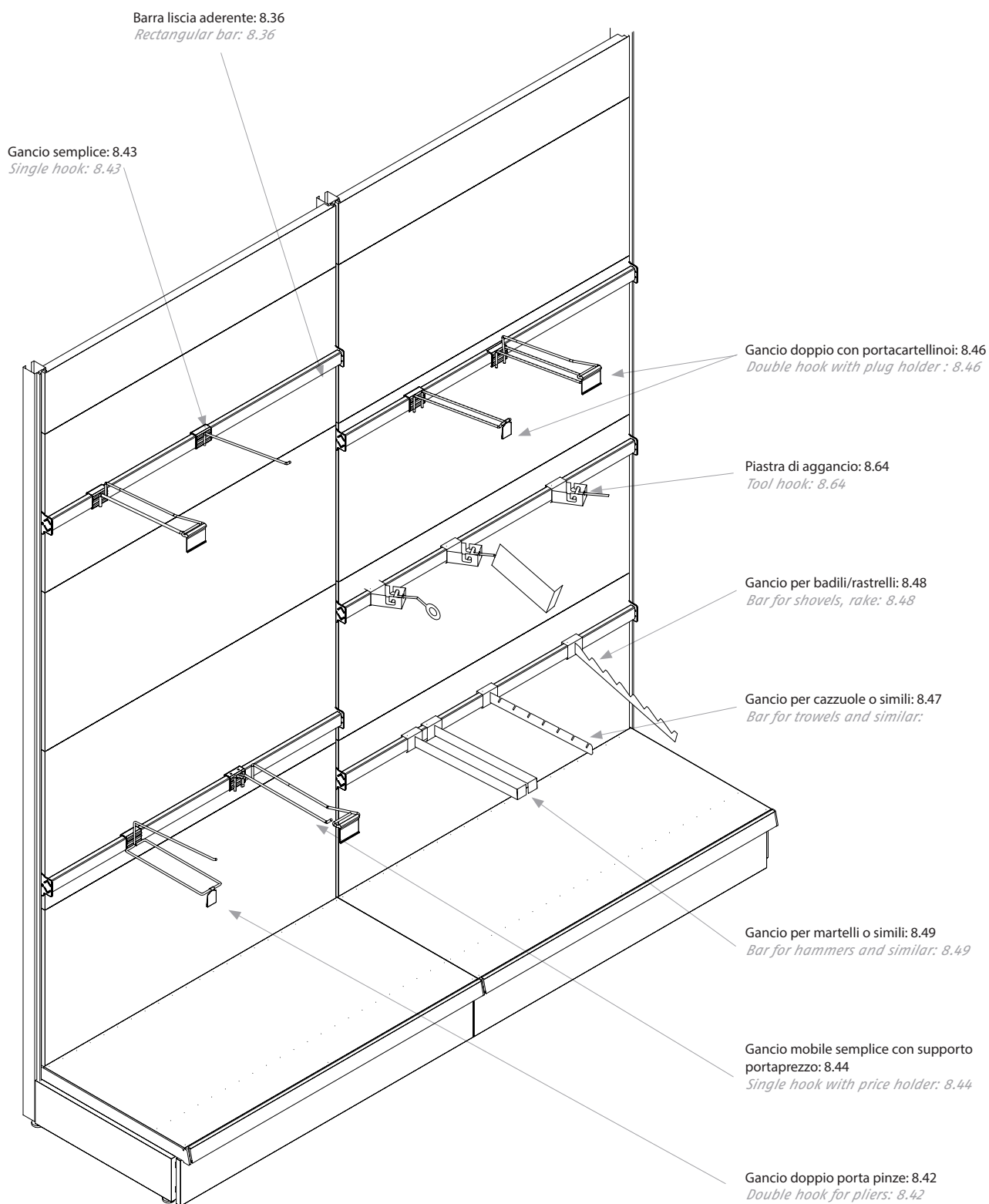





Barra Forata  
Perforated Bar

8.35

Barra forata aderente  
*Rectangular perforated bar*

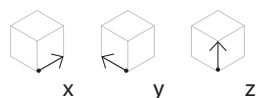
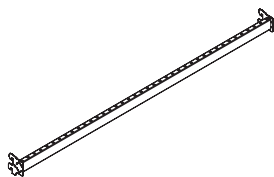

	x	y	z	codice code	finitura e colore finish & colour	note notes
50	--	--	--	23.-03	C	
66,5	--	--	--	23.124	C	
75	--	--	--	23.-02	C	
100	--	--	--	23.-01	C	
133	--	--	--	23.-04	C	

Mensola sinistra per innesto della barra forata  
*Lh bracket for perforated bar*

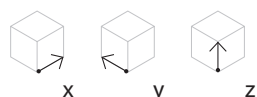

	x	y	z	codice code	finitura e colore finish & colour	note notes
--	--	--	--	16.-84	C	

Da utilizzare per realizzare misure speciali tagliando la barra forata

*To be used to tailor bar size by cutting it.*



Barra Forata  
Perforated Bar

8.36

Barra liscia aderente  
*Rectangular bar*

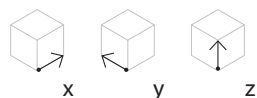
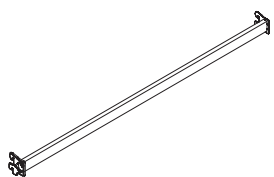

	x	y	z	codice code	finitura e colore finish & colour	note notes
50	--	--	--	23.425	C	
66,5	--	--	--	23.437	C	
75	--	--	--	23.424	C	
100	--	--	--	23.423	C	
133	--	--	--	23.426	C	

Mensola sinistra per innesto della barra forata  
*Lh bracket for perforated bar*

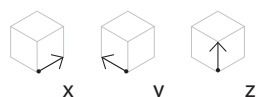

	x	y	z	codice code	finitura e colore finish & colour	note notes
--	--	--	--	16.-84	C	

Da utilizzare per realizzare misure speciali tagliando la barra forata

*To be used to tailor bar size by cutting it.*



Barra Forata  
Perforated Bar

8.37

Barra forata sporgente con angoli in PVC  
Forward perforated rectangular bar with PVC joins

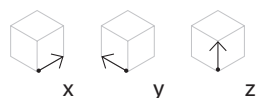
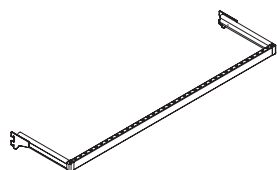

	x	y	z	codice code	finitura e colore finish & colour	note notes
	50	25	--	23.235	C	
	66,5	25	--	23.236	C	
	75	25	--	23.234	C	
	100	25	--	23.233	C	
	133	25	--	23.237	C	



Accessori  
Accessories

8.38

Gancio semplice per barra forata  
Single hook for perforated bar

→ Utilizzare con protezione in PVC: 8.33 Use with PVC cap: 8.33

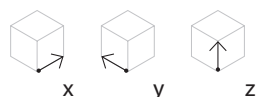

	x	y	z	codice code	finitura e colore finish & colour	note notes
∅ 0,6	--	20	--	23.-09	C	
∅ 0,6	--	30	--	23.-10	C	
∅ 0,7	--	40	--	23.-11	C	
∅ 1	--	50	--	23.-12	C	





Accessori  
Accessories

8.39

Gancio semplice con supporto portaprezzo per barra forata  
*Single hook with price holder for perforated bar*



				codice code	finitura e colore finish & colour	note notes
∅ 0,6	--	20	--	35.-82	C	
∅ 0,6	--	30	--	35.-53	C	
∅ 0,7	--	40	--	35.-46	C	
∅ 1	--	50	--	35.-83	C	





Accessori  
Accessories

8.40

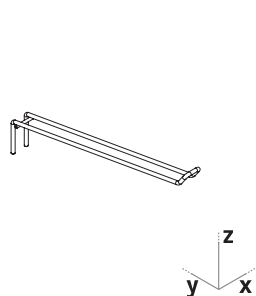
Gancio doppio per barra forata  
*Double hook for perforated bar*



				codice code	finitura e colore finish & colour	note notes
∅ 0,5	2,8	30	--	23.-89	C	
∅ 0,5	2,8	40	--	23.276	C	





Accessori  
Accessories

8.41

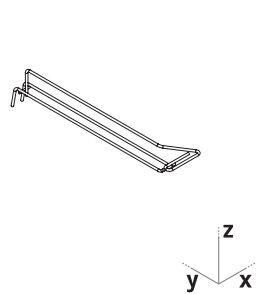
Gancio doppio con supporto portaprezzo per barra forata  
*Double hook with price holder for perforated bar*



				codice code	finitura e colore finish & colour	note notes
∅ 0,5	2,8	30	--	23.209	C	
∅ 0,5	2,8	40	--	23.210	C	



Accessori  
Accessories

8.42

Gancio doppio per barra forata / per pinze o simili  
*Double hook for perforated bar / for pliers and similar*

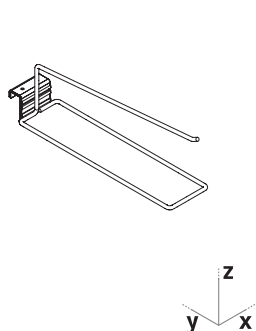

				codice code	finitura e colore finish & colour	note notes
	--	30	--	23.284	C	







Accessori  
Accessories

8.43

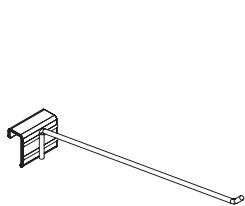
Gancio mobile per barra  
Single hook with plug holder for bar

→ Utilizzare con protezione in PVC: 8.33 Use with PVC cap: 8.33



				codice code	finitura e colore finish & colour	note notes
∅ 0,6	--	20	--	35.239	C	
∅ 0,6	--	30	--	35.240	C	
∅ 0,7	--	40	--	35.230	C	





Accessori  
Accessories

8.44

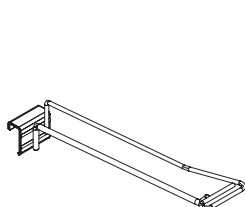
Gancio mobile per barra con supporto portaprezzo  
Single hook with plug and price holder for bar



				codice code	finitura e colore finish & colour	note notes
∅ 0,6	--	20	--	35.242	C	
∅ 0,6	--	30	--	35.231	C	
∅ 0,7	--	40	--	35.229	C	
∅ 10	--	50	--	35.235	C	





Accessori  
Accessories

8.45

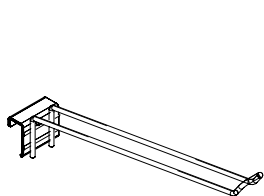
Gancio doppio mobile per barra  
Double hook with plug holder for bar



				codice code	finitura e colore finish & colour	note notes
∅ 0,5	2,8	20	--	35.243	C	
∅ 0,5	2,8	30	--	35.244	C	
∅ 0,5	2,8	40	--	35.245	C	





Accessori  
Accessories

8.46

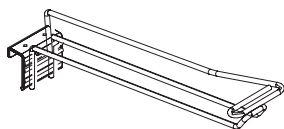
Gancio doppio mobile per barra con supporto portaprezzo  
Double hook with plug holder for bar



				codice code	finitura e colore finish & colour	note notes
∅ 0,5	2,8	20	--	35.247	C	
∅ 0,5	2,8	30	--	35.248	C	
∅ 0,5	2,8	40	--	35.249	C	

Accessori  
Accessories

**8.47** Gancio per barra forata / per cazzuole o simili  
*Bar for perforated bar / for trowels and similar*

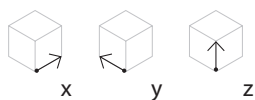
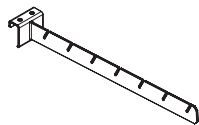

	x	y	z	codice code	finitura e colore finish & colour	note notes
	--	35	--	23.285	C	

Accessori  
Accessories

**8.48** Gancio per barra forata / per badili, rastrelli o simili  
*Bar for perforated bar / for shovels, rake and similar*

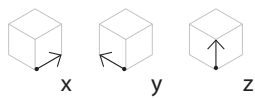
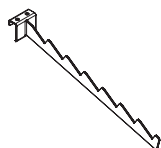

	x	y	z	codice code	finitura e colore finish & colour	note notes
	--	35	--	23.286	C	

Accessori  
Accessories

**8.49** Gancio per barra forata / per martelli o simili  
*Bar for perforated bar / for hammers and similar*

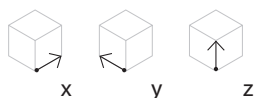
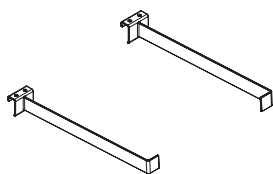

	x	y	z	codice code	finitura e colore finish & colour	note notes
dx rh	3	35	3	23.287	C	
sx lh	3	35	3	23.288	C	

Accessori  
Accessories

**8.50** Gancio ad un anello / per palloni  
*Round hook for perforated bar / for balls*

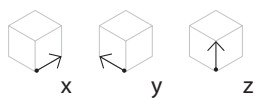
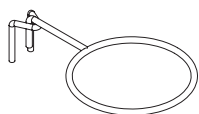

	x	y	z	codice code	finitura e colore finish & colour	note notes
	12	20	--	23.-32	C	



Accessori  
Accessories

8.51

Espositore inclinato per barra forata / per palloni  
*Sloped wire rack for perforated bar / for balls*

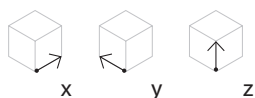
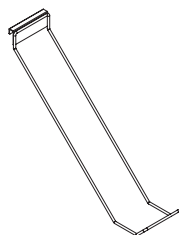

x	y	z	codice code	finitura e colore finish & colour	note notes
15	--	80	23.200	C	



Accessori  
Accessories

8.52

Gancio a due anelli per barra forata / per asciugacapelli  
*Hook with two rings for perforated bar / for hairdryer*

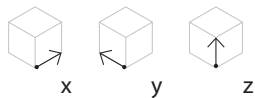
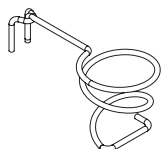

x	y	z	codice code	finitura e colore finish & colour	note notes
--	--	8,5	23.122	C	



Accessori  
Accessories

8.53

Gancio a due anelli per barra forata / per vaso portafiori  
*Hook with two rings for perforated bar / for flowerpot*

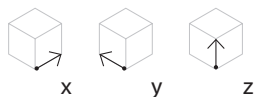
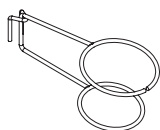

x	y	z	codice code	finitura e colore finish & colour	note notes
--	--	8,5	34.407	C	

Vaso portafiori in PVC  
*PVC flowerpot*

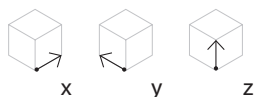

x	y	z	codice code	finitura e colore finish & colour	note notes
--	--	35	34.406	N	



Accessori  
Accessories

8.54

Espositore per telefoni cellulari in metacrilato per barra forata  
*Methacrylate mobile telephone holder for perforated bar*

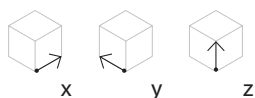
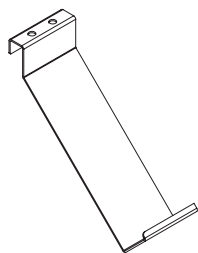

x y z

codice  
code

finitura e  
colore  
finish &  
colour

note  
notes

6,5 18 -- 23.252

T TRA



Accessori  
Accessories

8.55

Espositore per aspirapolveri per barra forata  
*Vacuum cleaner rack for perforated bar*

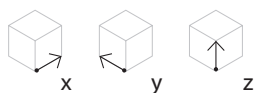
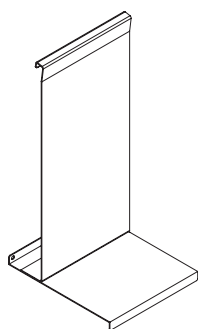

x y z

codice  
code

note  
notes

30 23 51 34.374

finitura  
finish

colori  
colours

V

- 2004
- 6018
- 6027
- 7035
- AMA
- ANT
- AZZ
- 1001
- BIA
- BLU
- GIÀ
- MAR
- MTZ
- PAN
- RO3
- BIMCL
- NRMCL
- OXI



Accessori  
Accessories

8.56

Espositore per scope elettriche per barra forata  
*Electric broom rack for perforated bar*

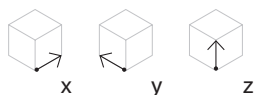
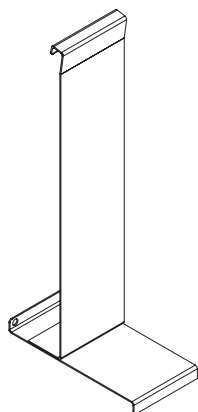

x y z

codice  
code

note  
notes

12 23 51 34.375

finitura  
finish

colori  
colours

V

- 2004
- 6018
- 6027
- 7035
- AMA
- ANT
- AZZ
- 1001
- BIA
- BLU
- GIÀ
- MAR
- MTZ
- PAN
- RO3
- BIMCL
- NRMCL
- OXI



Accessori  
Accessories

8.57

Supporto per tubo aspirapolveri per barra forata  
*Vacuum cleaner hose support for perforated bar*

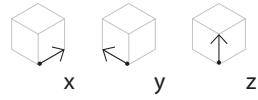
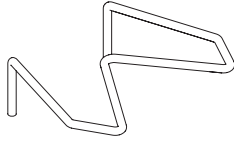

x	y	z	codice code	finitura e colore finish & colour	note notes
7,5	15	--	23.138	C	



Accessori  
Accessories

8.58

Supporto per ferro da stiro per barra forata  
*Electric iron rack for perforated bar*

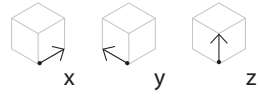
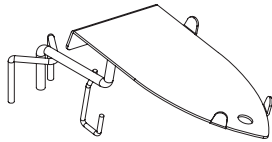

x	y	z	codice code	note notes	finitura finish	colori colours
11,5	22	--	23.140		V	

	2004
	6018
	6027
	• 7035
	AMA
	• ANT
	AZZ
	1001
	• BIA
	BLU
	GIA
	MAR
	• MTZ
	• PAN
	RO3
	BIMCL
	NRMCL
	• OXI

Tappo alettato in PVC con attacco porta prezzo per espositore  
per ferro da stiro  
*PVC finning plug with price holder for electric iron rack*



x	y	z	codice code	finitura e colore finish & colour	note notes
--	--	--	12.-47	T BIA	

Porta prezzo in PVC  
*PVC price tag holder*

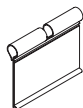

x	y	z	codice code	finitura e colore finish & colour	note notes
6,5	--	4	35.112	TTRA	





Accessori  
Accessories

8.59

**Tubo fisso per barra forata**  
*Fixed tubular bar for perforated bar*

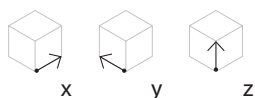
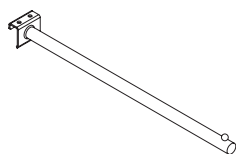

	x	y	z	codice code	finitura e colore finish & colour	note notes
--	32	--	--	23.-74	C	
--	46	--	--	23.-75	C	



**Tappo alettato in PVC con attacco tubo fisso**  
*PVC finning plug with price holder for fixed tubular bar*

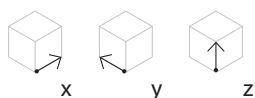

	x	y	z	codice code	finitura e colore finish & colour	note notes
--	--	--	--	CP.-20		
--	--	--	--	12.-54	TBIA	C/PORTACARTELLINO

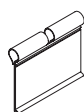

**Porta prezzo in PVC**  
*PVC price tag holder*

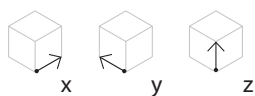

	x	y	z	codice code	finitura e colore finish & colour	note notes
6,5	--	4	4	35.112	TTRA	



Accessori  
Accessories

8.60

**Espositore in filo per Scarpa per pannello legno**  
*Wire display for Shoes for wooden backpanel*

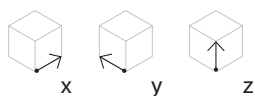
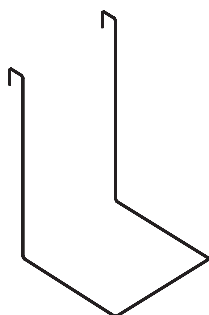

	x	y	z	codice code	finitura e colore finish & colour	note notes
14	14	21	21	23.417	C	

Per dogia fondale legno: 3.22  
For wooden slat: 3.22







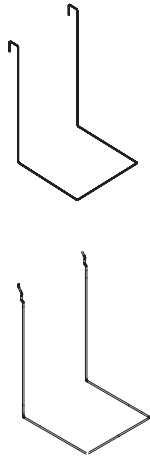

Accessori  
Accessories

8.61

Espositore in filo per Scarpa antinfortunistica per barre o pannelli forati  
*Wire display for safety-shoes for bars or perforated backpanels*



	 x	 y	 z	codice code	finitura e colore finish & colour	note notes
Per barra liscia For bar	14	14	21	23.430	C	
Per pannelli forati e asolati For perforated backpanels	14	14	21	23.431	C	



Accessori  
Accessories

8.62

Espositore in filo per Caschi  
*Motorbike Helmet wire holder*

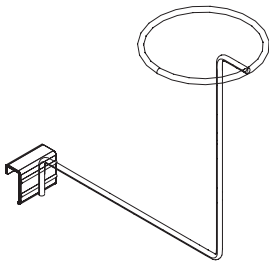

	 x	 y	 z	codice code	finitura e colore finish & colour	note notes
	--	25	25	35.258	C	





Accessori  
Accessories

8.63

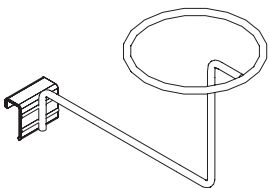
Espositore in filo per cappelli  
*Hat wire holder*



	 x	 y	 z	codice code	finitura e colore finish & colour	note notes
	--	25	10	23.-18	C	



Accessori  
Accessories

8.64

Piastra di aggancio per barra forata  
*Tool hook for perforated bar*

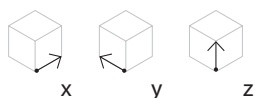
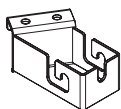

x	y	z	codice code	finitura e colore finish & colour	note notes
--	7,5	--	23.195	C	

Espositore con attacco piastra / per trapano  
*Drill holder for tool hook*

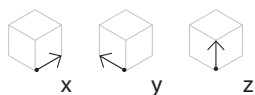
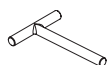

x	y	z	codice code	finitura e colore finish & colour	note notes
--	9	--	23.196	C	

Espositore con attacco piastra / per mola disco  
*Cut-off wheel disc rack for tool hook*

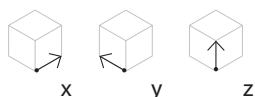
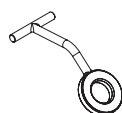

x	y	z	codice code	finitura e colore finish & colour	note notes
--	--	--	23.197	C	

Espositore con attacco piastra / per levigatrici  
*Sanding machine rack for tool hook*

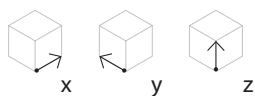
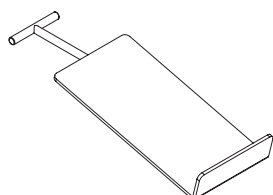

x	y	z	codice code	finitura e colore finish & colour	note notes
9	3	18	23.198	C	



Accessori  
Accessories

8.65

Espositore per barra forata / per trapani e avvitatori  
*Drill holder for perforated bar*

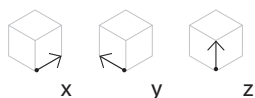
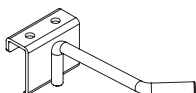

x	y	z	codice code	finitura e colore finish & colour	note notes
2	10	--	23.289	C	





Accessori  
Accessories

8.66

Espositore per barra forata / per piatti  
*Plate rack for perforated bar*

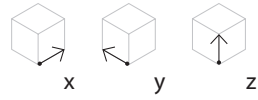
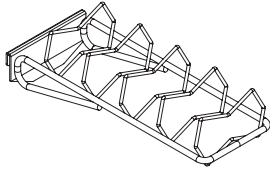

x	y	z	codice code	finitura e colore finish & colour	note notes
16	40	--	28.-69	C	



Accessori  
Accessories

8.67

Espositore per barra forata / per coperchi  
*Pan lid holder for perforated bar*

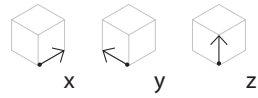
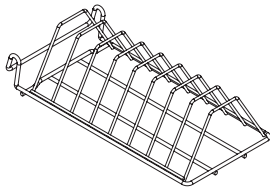

x	y	z	codice code	finitura e colore finish & colour	note notes
15	50	--	23.205	C	



Espositori  
Displays

8.68

Porta LCD dritto / inclinato  
*Straight / angled LCD holder*

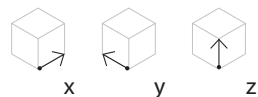
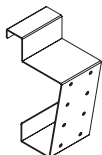
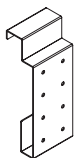

	x	y	z	codice code	finitura e colore finish & colour	note notes
per barra for bar	10	--	26	23.335	C	
	25	--	26	23.334	C	
per barra for bar	10	--	24	23.337	C	
	25	--	24	23.336	C	

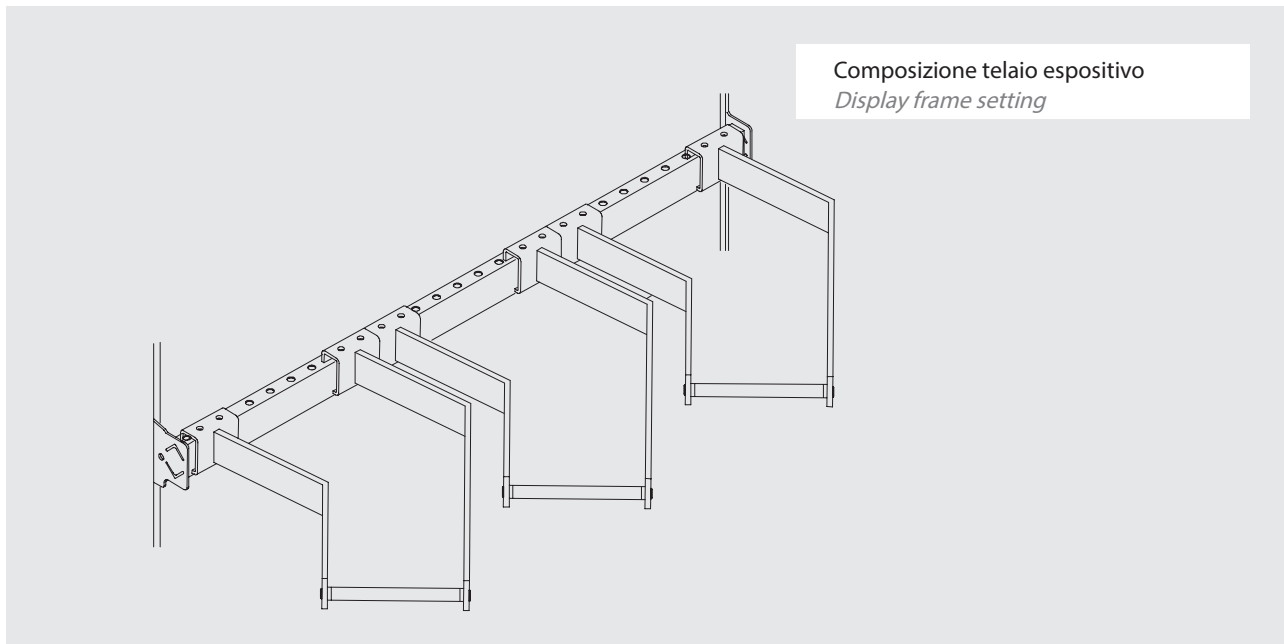

Composizione telaio espositivo  
*Display frame setting*

**8.69** Braccio per barra forata per telaio espositivo  
*Accessori Accessories*

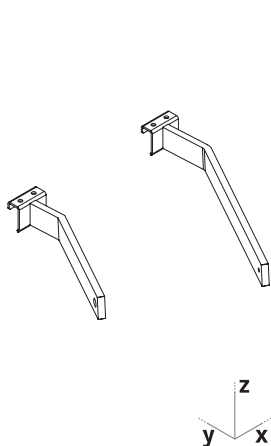

	x	y	z	codice code	note notes
dx rh	--	35	--	22.432	
sx lh	--	23,5	--	22.431	

finitura finish	colori colours
V	
	2004
	6018
	6027
	• 7035
	AMA
	• ANT
	AZZ
	1001
	• BIA
	BLU
	GIÀ
	MAR
	• MTZ
	• PAN
	RO3
	BIMCL
	NRMCL
	• OXI

Per barra forata: 8.35 - 8.36  
*For perforated bar: 8.35 - 8.36*

Traverso tubolare con viti per telaio espositivo  
*Crosspiece with screws for display frame for perforated bar*

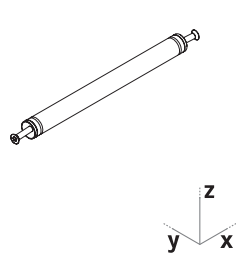

x	y	z	codice code	finitura e colore finish & colour	note notes
22	--	--	22.436	C	



Accessori  
Accessories

8.70

Divisorio in filo per barra forata  
*Wire divider for perforated bar*

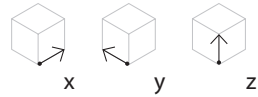
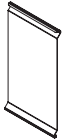
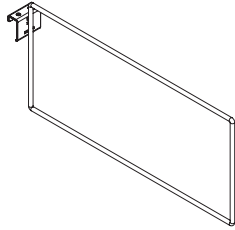

	x	y	z	codice code	finitura e colore finish & colour	note notes
--	45	20	23.290	C		

Porta prezzo in lamiera per divisorio in filo per barra forata  
*Price tag holder for wire divider*

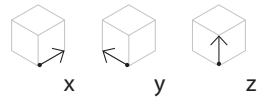

	x	y	z	codice code	finitura e colore finish & colour	note notes
--	10,5	18,5	23.291	C		



Accessori  
Accessories

8.71

Divisorio in filo per barra forata  
*Wire divider for perforated bar*

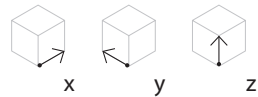
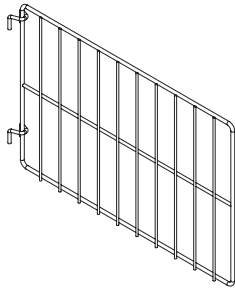

	x	y	z	codice code	finitura e colore finish & colour	note notes
--	50	36	23.255	C		
--	60	36	23.256	C		

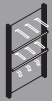

Accessori  
Accessories

8.72

Supporto porta prezzo per barra forata  
*Support for price tag holder for perforated bar*

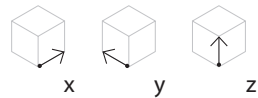
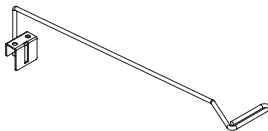

	x	y	z	codice code	finitura e colore finish & colour	note notes
--	20	--	23.111	C		
--	30	--	23.112	C		
--	40	--	23.113	C		
--	50	--	23.114	C		

Componenti per Accessori  
Elements for Accessories

**8.73** Porta prezzo in PVC  
PVC price tag holder

	x	y	z	codice code	finitura e colore finish & colour	note notes
per ganci doppi for double hooks	2,5	--	5	35.117	T TRA	
per ganci semplici for single hooks	6,5	--	4	35.255	T TRA	
per tappo alettato for finning plugs	6,5	--	4	35.112	T TRA	



Accessori  
Accessories

**8.74** Barra tubolare con aggancio per espositore portapiatti  
Heavy duty rectangular bar to be used with plate rack

	x	y	z	codice code	note notes	finitura finish	colori colours	colori colours
75	--	--	23.351		V			
100	--	--	23.258				2004	MAR
133	--	--	23.202				6018	• MTZ
							6027	• PAN
							• 7035	RO3
							AMA	BIMCL
							• ANT	NRMCL
							AZZ	• OXI
							1001	
							• BIA	
							BLU	
							GIA	



Accessori  
Accessories

**8.75** Espositore portapiatti per barra tubolare  
Plate rack for heavy duty rectangular bar

	x	y	z	codice code	note notes	finitura finish	colori colours	colori colours
19	45	7	23.203		V			
							2004	MAR
							6018	• MTZ
							6027	• PAN
							• 7035	RO3
							AMA	BIMCL
							• ANT	NRMCL
							AZZ	• OXI
							1001	
							• BIA	
							BLU	
							GIA	





Accessori  
Accessories

8.76

Avanzatore per espositore portapiatti  
Pushing plate wire fork for plate rack

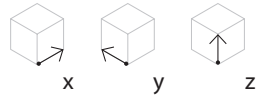
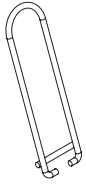

x	y	z	codice code	note notes
--	--	--	23.204	

finitura finish	colori colours
V	
	2004
	6018
	6027
	• 7035
	AMA
	• ANT
	AZZ
	1001
	• BIA
	BLU
	GIA
	MAR
	• MTZ
	• PAN
	RO3
	BIMCL
	NRMCL
	• OXI



# Barra ovale e accessori

## *Oval bar and accessories*

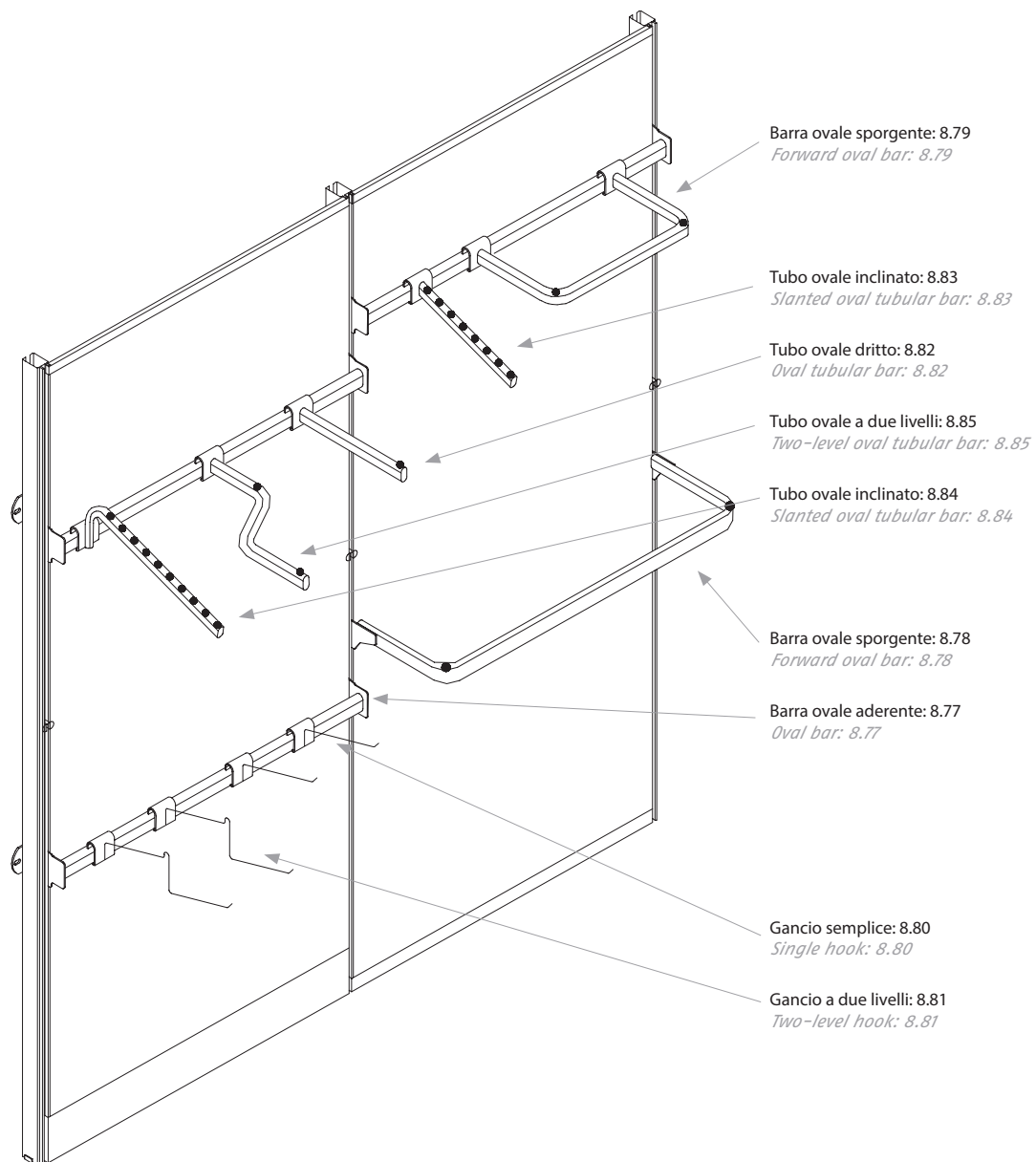







Accessori  
Accessories

8.83

Tubo ovale inclinato per barra ovale  
*Slanted oval tubular bar for oval bar*

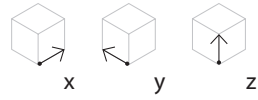
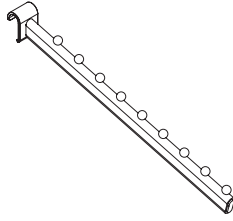

codice code
-- 35 -- 23.329

note notes

finitura finish

colori colours

colori colours

C	V	colori colours	colori colours
•	---		MAR
	2004		MTZ
	6018		PAN
	6027		RO3
	7035		BIMCL
	AMA		NRMCL
	ANT		OXI
	AZZ		
	1001		
	BIA		
	BLU		
	GIA		



Accessori  
Accessories

8.84

Tubo ovale inclinato per barra ovale  
*Slanted oval tubular bar for oval bar*

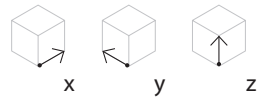
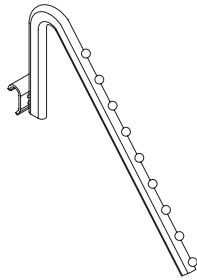

codice code
-- 35 -- 23.331

note notes

finitura finish

colori colours

colori colours

C	V	colori colours	colori colours
•	---		MAR
	2004		MTZ
	6018		PAN
	6027		RO3
	7035		BIMCL
	AMA		NRMCL
	ANT		OXI
	AZZ		
	1001		
	BIA		
	BLU		
	GIA		



Accessori  
Accessories

8.85

Tubo ovale a due livelli per barra ovale  
*Two-level oval tubular bar for oval bar*

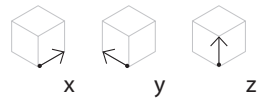
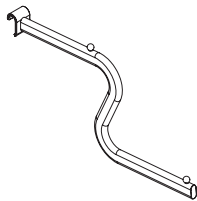

codice code
-- 38 19 23.330

note notes

finitura finish

colori colours

colori colours

C	V	colori colours	colori colours
•	---		MAR
	2004		MTZ
	6018		PAN
	6027		RO3
	7035		BIMCL
	AMA		NRMCL
	ANT		OXI
	AZZ		
	1001		
	BIA		
	BLU		
	GIA		



Accessori  
Accessories

8.86

Portacravatte per barra ovale  
*Tie rack for oval bar*

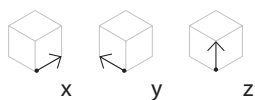
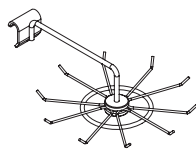

x	y	z	codice code	note notes
--	20	--	23.332	

finitura finish		colori colours
C	V	
		2004
		6018
		6027
		7035
		AMA
		ANT
		AZZ
		1001
		BIA
		BLU
		GIA
		MAR
		MTZ
		PAN
		RO3
		BIMCL
		NRMCL
		OXI
		---

# Espositori specifici

## *Particular displays*

## Tabacchi

### *Tobacco*

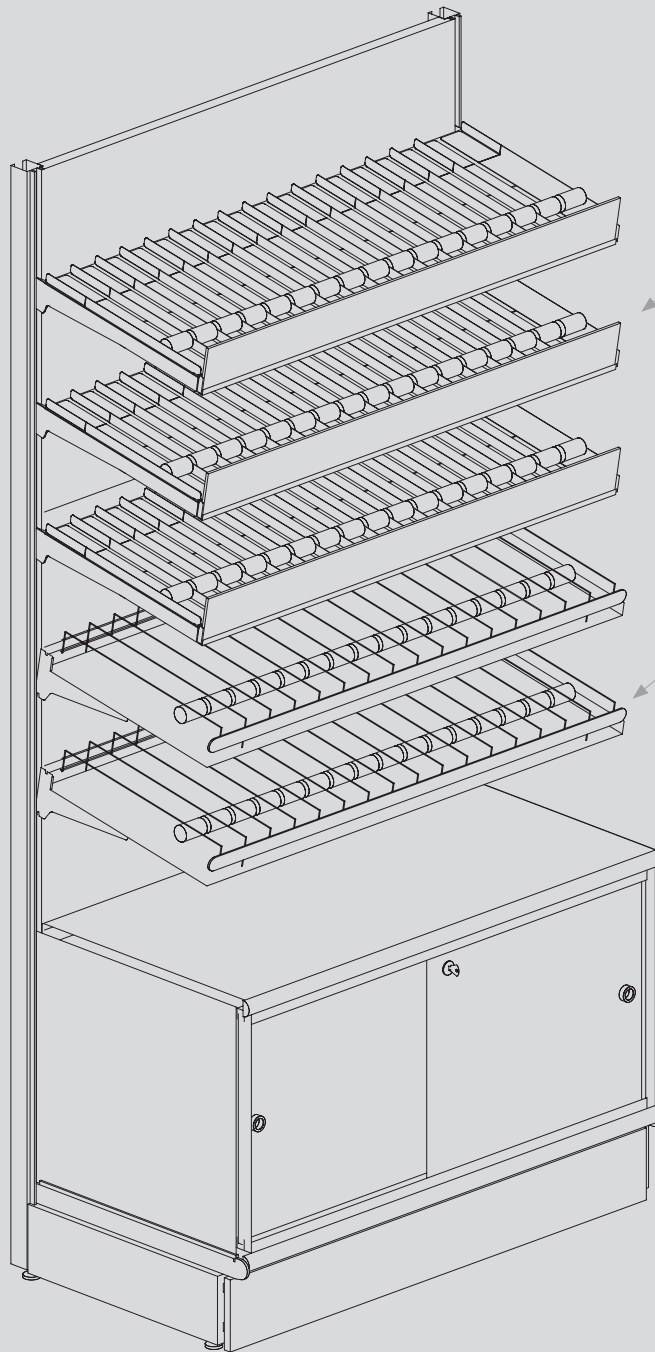

Piano tabacchi in metallo: 8.87  
*Tobacco metal shelf: 8.87*

Cilindro spingitore: 8.93  
*Pushing Cylinder: 8.93*

Profilo alluminio per piano a lista: 6.13  
*Aluminium profile for plank shelf: 6.13*

Piano tabacchi in legno 8.89  
*Tobacco wooden shelf: 8.89*

Separatore fisso in filo: 8.91  
*Wire separator: 8.91*

Mobile base con ante scorrevoli: 9.23  
*Base cabinet with sliding doors: 9.23*

**Espositori Displays** **8.87** **Piano Tabacchi in metallo completo di divisori regolabili e 17 spingitori**  
*Tobacco metal shelf with adjustable divider and 17 pushing cylinder*

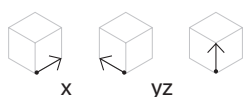
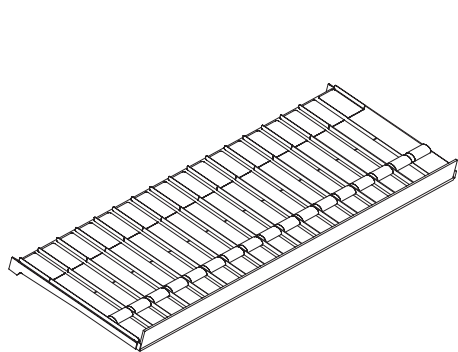

		codice code	
100	40	--	40.555
100	30	--	40.556

note notes	finitura finish	colori colours	colori colours
	V	2004	MAR
		6018	• MTZ
		6027	• PAN
	• 7035		RO3
	AMA		BIMCL
	• ANT		NRMCL
	AZZ		• OXI
	1001		GIA
	• BIA		
	BLU		

Profilo vedi sezioni 6.1 / 6.13 / 6.20  
 Holder view section 6.1 / 6.13 / 6.20

**Espositori Displays** **8.89** **Piano Tabacchi in Legno completo di separatore in filo e 16 spingitori**  
*Tobacco wooden shelf with wire separator and 16 pushing cylinder*

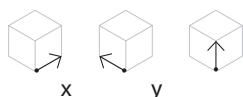
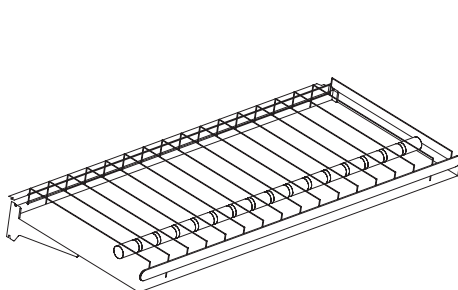

		codice code	
100	40	--	17.942

note notes	finitura finish	colori colours	colori colours
	T		
•		7035	A838
•		ACE	999XA
•		BIA	995XM
		FAG	989XR
•		MTZ	994XS
•		PAN	997XS
•		A439	983XR
•		ANT	984XA
		K101	BLACK
		3813	GREEN
		2293	BEIGE
		990XA	WHITE
		990XM	

**Espositori Displays** **8.90** **Divisorio mobile metallo**  
*Metal separator for Tobacco metal shelf*

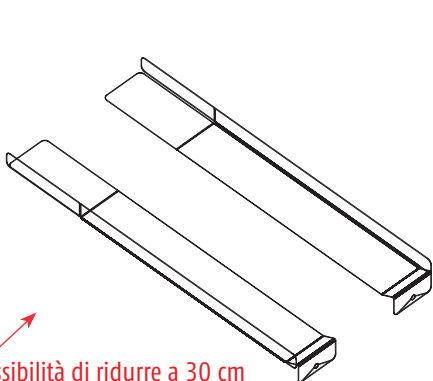

possibilità di ridurre a 30 cm con pretaglio

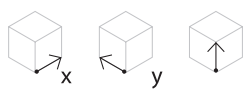

		codice code	
100	40	4	19.419
100	40	4	19.420

note notes	finitura finish	colori colours	colori colours
	V		
		2004	MAR
		6018	• MTZ
		6027	• PAN
	• 7035		RO3
	AMA		BIMCL
	• ANT		NRMCL
	AZZ		• OXI
	1001		GIA
	• BIA		
	BLU		

modulare  
 modulare terminale



8.91

Separatore fisso in filo per piano Tabacchi in legno  
*Wire separator for Tobacco wooden shelf*

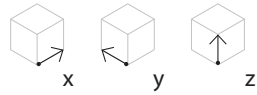
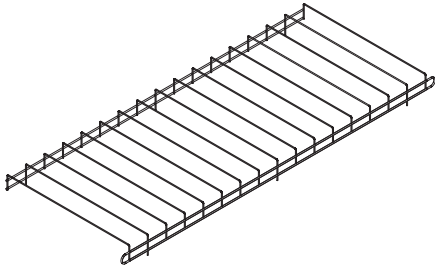

	x	y	z	codice code	finitura finish colori colours	note notes
	100	40	--	22.553	C	

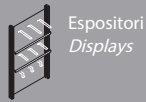

8.93

Spingitore Tabacchi  
*Pushing cylinder for tobacco shelf*

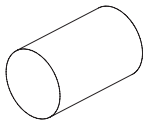

	x	yz	z	codice code	finitura finish colori colours	note notes
	50	30	--	34.893	C	





# Espositori specifici

## *Particular displays*

### Cartotecnica

#### *Paper&Press*

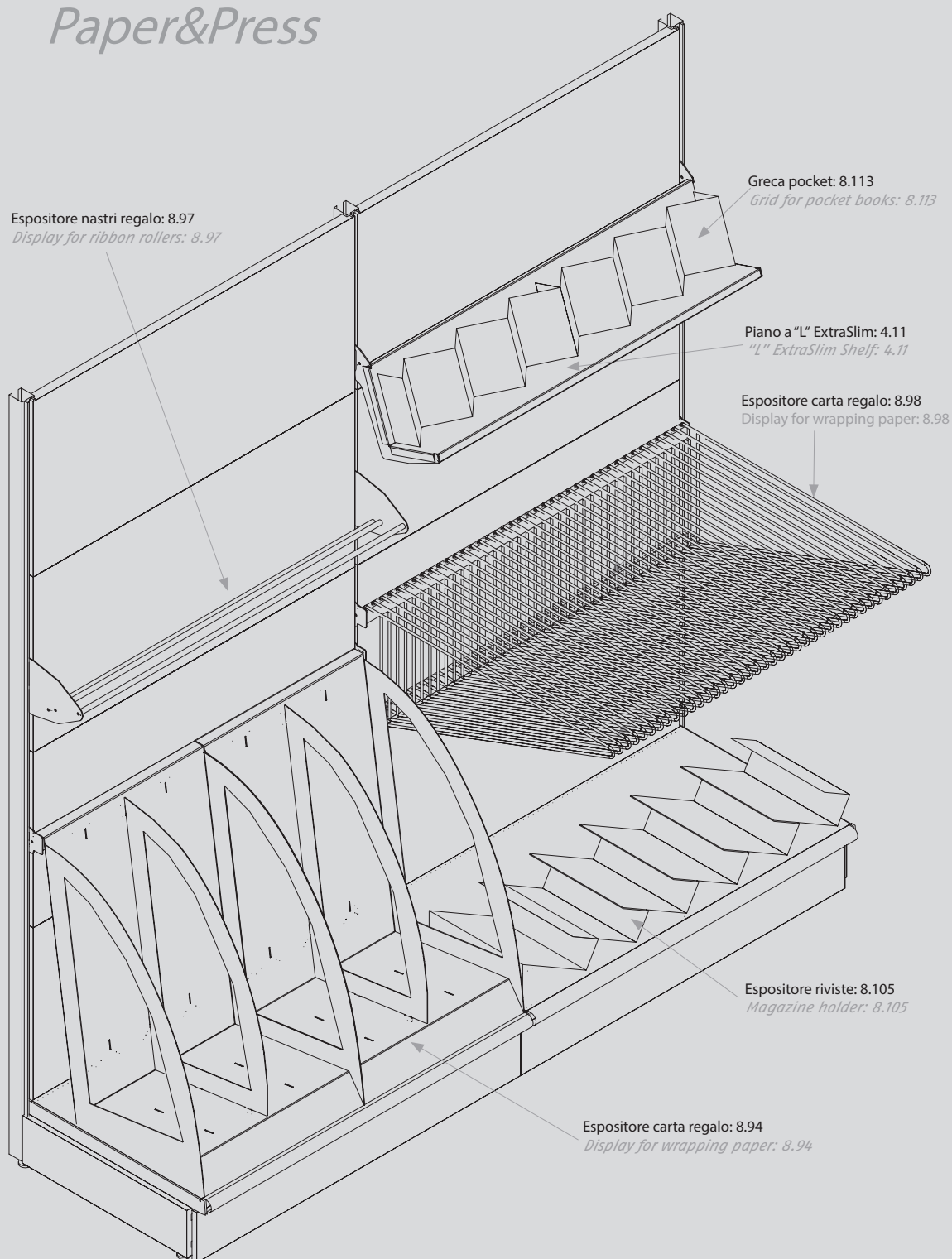

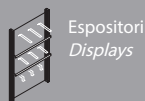

8.94

Espositore curvo per piano base con attacco barra  
*Shaped display on base shelf bar attachment*

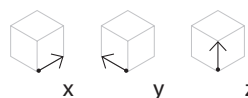
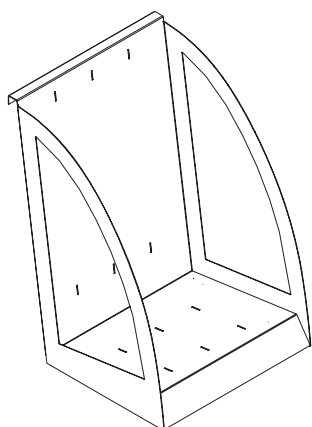

x	y	z	codice code
50	50	80	34.609
66,5	50	80	34.626

note notes

finitura finish

colori colours

colori colours

finitura finish	colori colours	colori colours
V	2004	MAR
	6018	• MTZ
	6027	• PAN
	• 7035	RO3
	AMA	BIMCL
	• ANT	NRMCL
	AZZ	• OXI
	1001	
	• BIA	
	BLU	
	GIA	

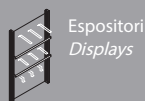

8.95

Espositore curvo sospeso con attacco barra  
*Shaped display on base shelf bar attachment*

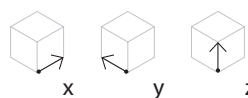
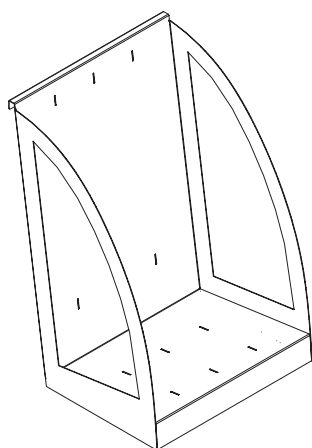

x	y	z	codice code
50	30	57	34.639
66,5	30	57	34.640

note notes

finitura finish

colori colours

colori colours

finitura finish	colori colours	colori colours
V	2004	MAR
	6018	• MTZ
	6027	• PAN
	• 7035	RO3
	AMA	BIMCL
	• ANT	NRMCL
	AZZ	• OXI
	1001	
	• BIA	
	BLU	
	GIA	



8.96

Divisorio per espositore curvo  
*Divider for shaped display*

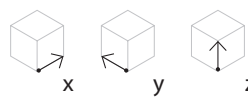
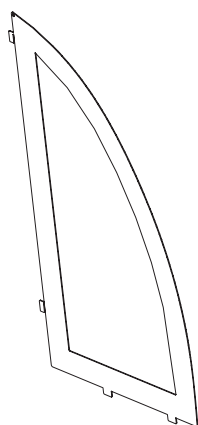

x	y	z	codice code
--	50	80	19.283
--	30	57	19.309

note notes

finitura finish

colori colours

colori colours

finitura finish	colori colours	colori colours
V	2004	MAR
	6018	• MTZ
	6027	• PAN
	• 7035	RO3
	AMA	BIMCL
	• ANT	NRMCL
	AZZ	• OXI
	1001	
	• BIA	
	BLU	
	GIA	

**Espositore porta nastri**  
*Display for ribbon rollers*

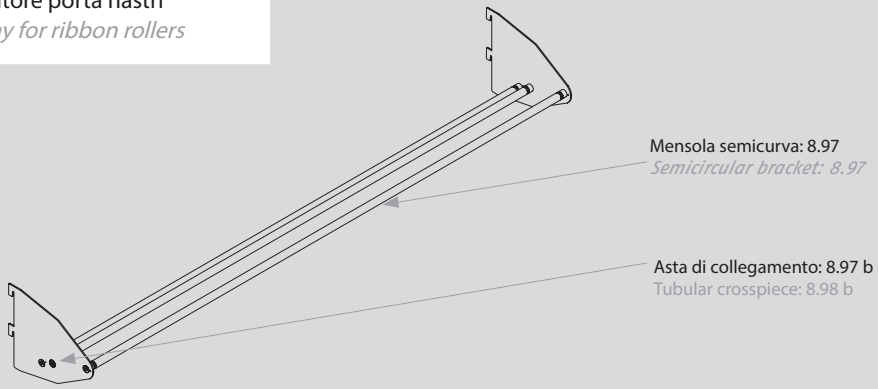

Espositori  
*Displays*

**8.97**

**Mensola semicurva per espositore portanastri**  
*Semicircular bracket for ribbon rollers*

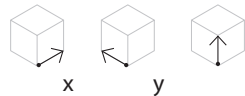
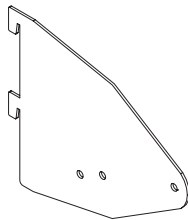

x	y	z	codice code	note notes
--	16	15	16.394	

finitura finish	colori colours
V	2004
	6018
	6027
•	7035
	AMA
•	ANT
	AZZ
	1001
•	BIA
	BLU
	GIA
	MAR
•	MTZ
•	PAN
	RO3
	BIMCL
	NRMCL
•	OXI



Espositori  
*Displays*

**8.97 b**

**Asta di collegamento**  
*Tubular crosspiece*

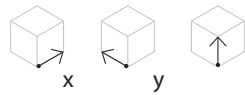
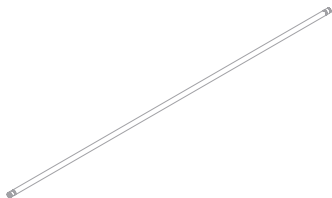

x	y	z	codice code	finitura e colore finish & colour	note notes
100	1,2	1,2	34.-22	C	

Espositore carta regalo  
Display for wrapping paper

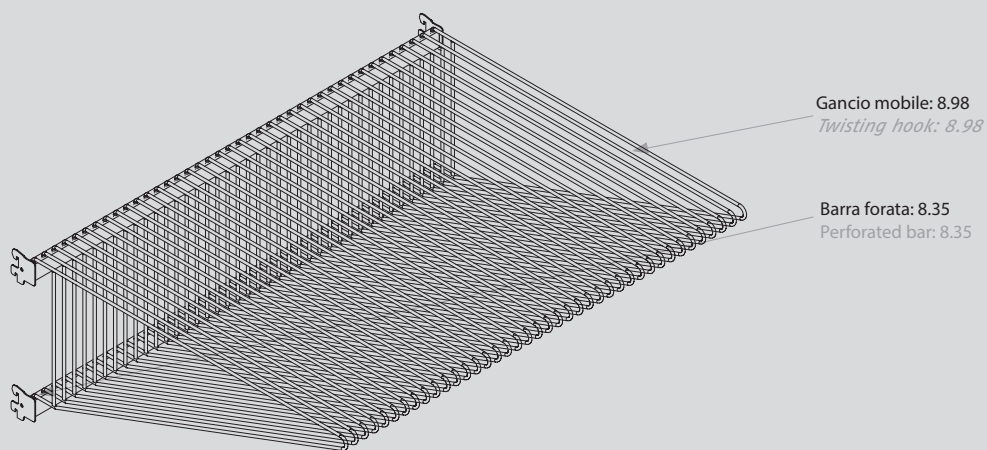

Espositori  
Displays

8.98

Gancio mobile su barra per esposizione carta regalo  
Twisting hook on bars for gift display

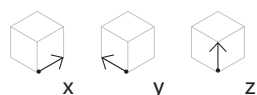
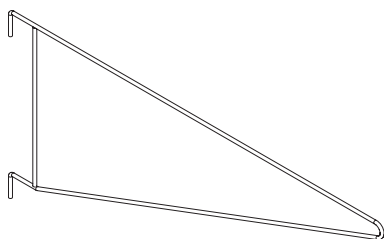

	x	y	z	codice code	note notes
	--	60	--	23.421	
	--	80	--	23.416	

finitura  
finish

colori  
colours

C	V
	2004
	6018
	6027
	7035
	AMA
	ANT
	AZZ
	1001
	BIA
	BLU
	GIA
	MAR
	MTZ
	PAN
	RO3
	BIMCL
	NRMCL
	OXI
•	---



Espositori  
Displays

8.99

Espositore per libri  
Book display island

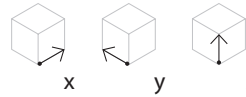
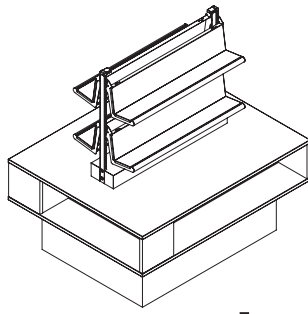

150 120 71/143

codice  
code

22.372

note  
notes

finitura  
finish

colori  
colours

colori  
colours

T			
•	7035	A838	
•	ACE	999XA	
•	BIA	995XM	
•	FAG	989XR	
•	MTZ	994XS	
•	PAN	997XS	
•	A439	983XR	
•	ANT	BLACK	
	K101	GREEN	
	3813	BEIGE	
	2293	WHITE	
	990XA		
	990XM		



Espositori  
Displays

8.100

Gradinata a cinque livelli / per riviste  
Five-step display rack / magazine holder

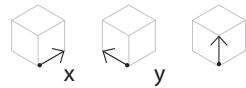
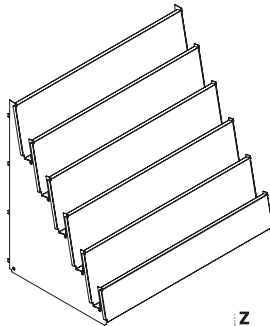

100 60 90

codice  
code

22.388

note  
notes

finitura  
finish

colori  
colours

colori  
colours

V			
	2004	MAR	
	6018	• MTZ	
	6027	• PAN	
•	7035	RO3	
	AMA	BIMCL	
•	ANT	NRMCL	
	AZZ	• OXI	
	1001		
•	BIA		
	BLU		
	GIA		



Espositori  
Displays

8.101

Gradinata a quattro livelli / per riviste  
Four-step display rack / magazine holder

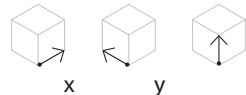
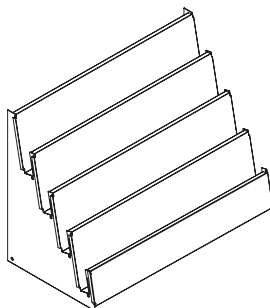

100 50 75

codice  
code

22.386

133 50 75 22.385



8.102

Gradinata a tre livelli / per riviste  
Three-step display rack / magazine holder

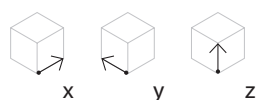
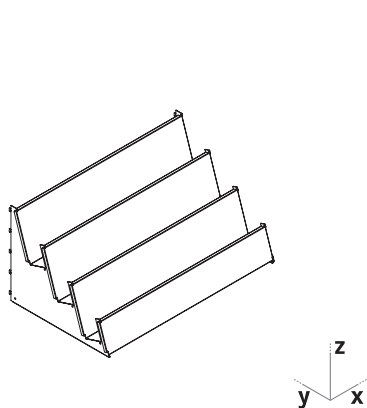

	x	y	z	codice code
	100	60	50	22.392
	133	60	50	22.391

note notes

finitura finish

colori colours

colori colours

finitura finish	colori colours	colori colours
V	2004	MAR
	6018	• MTZ
	6027	• PAN
	• 7035	RO3
	AMA	BIMCL
	• ANT	NRMCL
	AZZ	• OXI
	1001	
	• BIA	
	BLU	
	GIA	

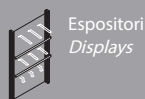

8.103

Gradinata a due gradini / per riviste  
Two-step display rack / magazine holder

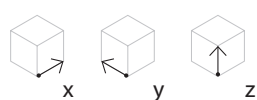
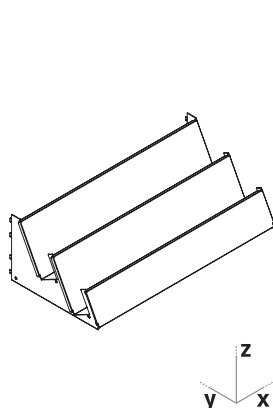

	x	y	z	codice code
	100	50	35	22.390
	133	50	35	22.389

note notes

finitura finish

colori colours

colori colours

finitura finish	colori colours	colori colours
V	2004	MAR
	6018	• MTZ
	6027	• PAN
	• 7035	RO3
	AMA	BIMCL
	• ANT	NRMCL
	AZZ	• OXI
	1001	
	• BIA	
	BLU	
	GIA	



8.104

Gradinata a tre livelli / per cd  
Three-step display rack / cd holder

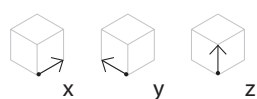
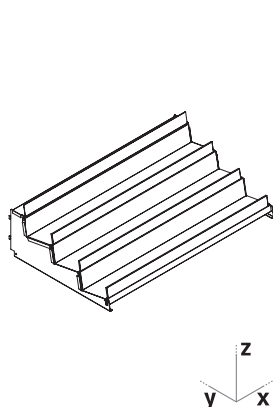

	x	y	z	codice code
	100	60	24	22.320

note notes

finitura finish

colori colours

colori colours

finitura finish	colori colours	colori colours
V	2004	MAR
	6018	• MTZ
	6027	• PAN
	• 7035	RO3
	AMA	BIMCL
	• ANT	NRMCL
	AZZ	• OXI
	1001	
	• BIA	
	BLU	
	GIA	



Accessori per Espositori  
Displays Accessories

8.107

Divisorio in filo a due posti per cd per piano da 15 e gradinata  
Wire fitting for cd for display shelf and display rack

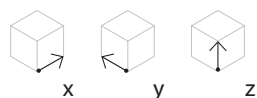
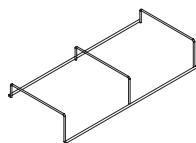

x	y	z	codice code	finitura e colore finish & colour	note notes
32,8	13,8	6	22.318	C	



Espositori  
Displays

8.108

Espositore aderente /per cd e libri  
Sticking shelf /cd/mc/hv/books holder

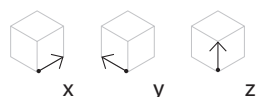
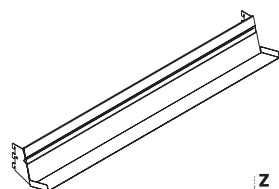

x	y	z	codice code	note notes	finitura finish	colori colours
50	8	13	17.754		V	
75	8	13	17.755			2004
100	8	13	17.548			6018

	6027
•	7035
	AMA
•	ANT
	AZZ
	1001
•	BIA
	BLU
	GIA
	MAR
•	MTZ
•	PAN
	RO3
	BIMCL
	NRMCL
•	OXI



Espositori  
Displays

8.109

Espositore sporgente /per cd e libri  
Prominent shelf /cd/mc/hv/books holder

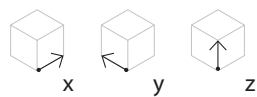
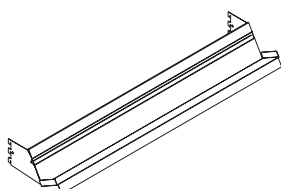

x	y	z	codice code	note notes	finitura finish	colori colours
50	8	13	17.756		V	
75	8	13	17.757			2004
100	8	13	17.575			6018

	6027
•	7035
	AMA
•	ANT
	AZZ
	1001
•	BIA
	BLU
	GIA
	MAR
•	MTZ
•	PAN
	RO3
	BIMCL
	NRMCL
•	OXI



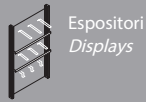

8.110

Gradinata a dieci gradini / per biglietti d'auguri  
*Ten-step display rack / card holder*

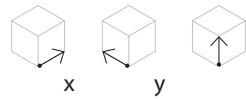
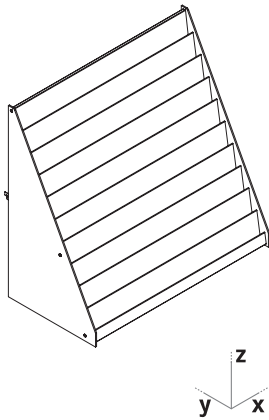

x	y	z	codice code	note notes
100	50	95	22.-21	

finitura finish	colori colours
P	
	2004
	6018
	6027
•	7035
	AMA
	ANT
	AZZ
	1001
•	BIA
	BLU
	GIA
	MAR
	MTZ
•	PAN
	RO3
	BIMCL
	NRMCL
	OXI



8.111

Attrezzo a M da appoggiare sui piani base / per libri  
*M shaped book support*

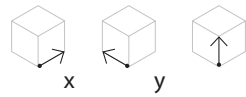
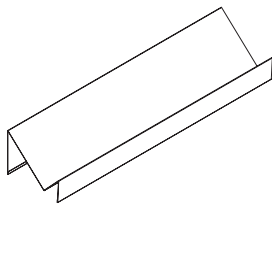

x	y	z	codice code	note notes
50	30	25	22.166	
75	30	25	22.165	
100	30	25	22.164	

finitura finish	colori colours
P	
	2004
	6018
	6027
•	7035
	AMA
	ANT
	AZZ
	1001
•	BIA
	BLU
	GIA
	MAR
	MTZ
•	PAN
	RO3
	BIMCL
	NRMCL
	OXI



8.112

Espositore per base da 50 cm senza appoggio posteriore / per riviste  
*Magazine support for 50 cm deep base unit*

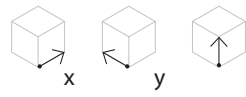
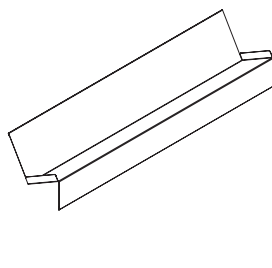

x	y	z	codice code	note notes
50	15	20	22.453	
75	15	20	22.461	
100	15	20	22.312	

finitura finish	colori colours	colori colours
V		
	2004	MAR
	6018	• MTZ
	6027	• PAN
•	7035	RO3
	AMA	BIMCL
•	ANT	NRMCL
	AZZ	• OXI
	1001	
•	BIA	
	BLU	
	GIA	



Espositori  
Displays

8.113

Greca esposizione Pocket  
Grid for pocket books

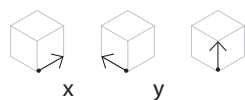
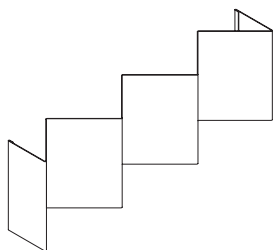

	x	y	z	codice code	note notes
	50	--	16,5	22.156	
	66,5	--	16,5	22.163	

finitura finish	colori colours
P	
	2004
	6018
	6027
•	7035
	AMA
	ANT
	AZZ
	1001
•	BIA
	BLU
	GIA
	MAR
	MTZ
•	PAN
	RO3
	BIMCL
	NRMCL
	OXI

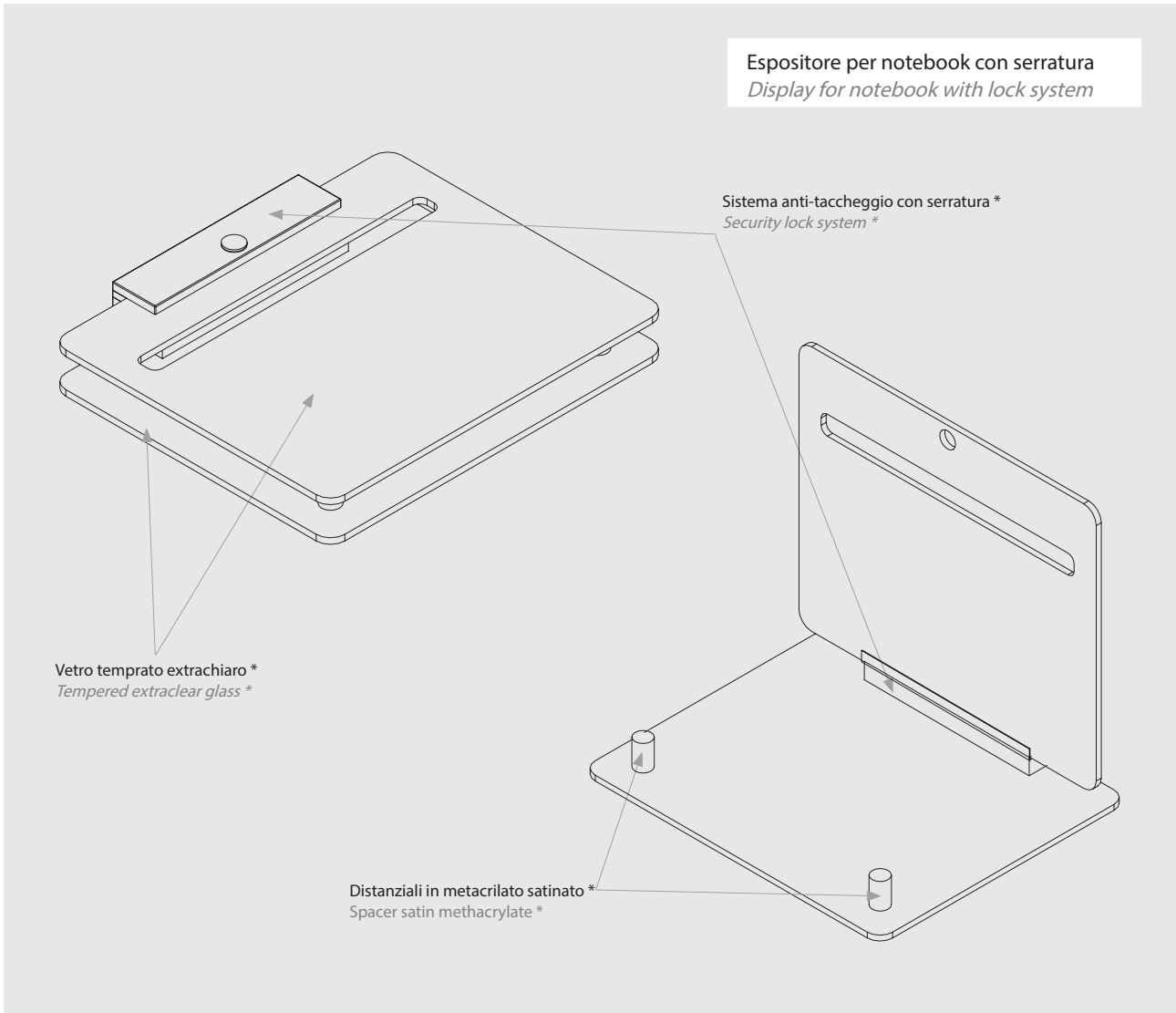

Espositori **8.114** **Espositore per notebook in vetro temprato extrachiaro con serratura**  
*Notebook display with tempered glass cover and lock*

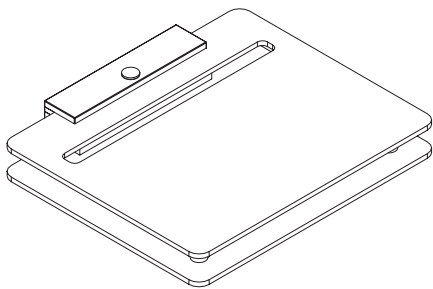

x	y	z	codice code	note notes
40	40	--	34.668	NT



\* Non disponibili separatamente  
\* *Not available separately*

Espositore per posate  
Cutlery display

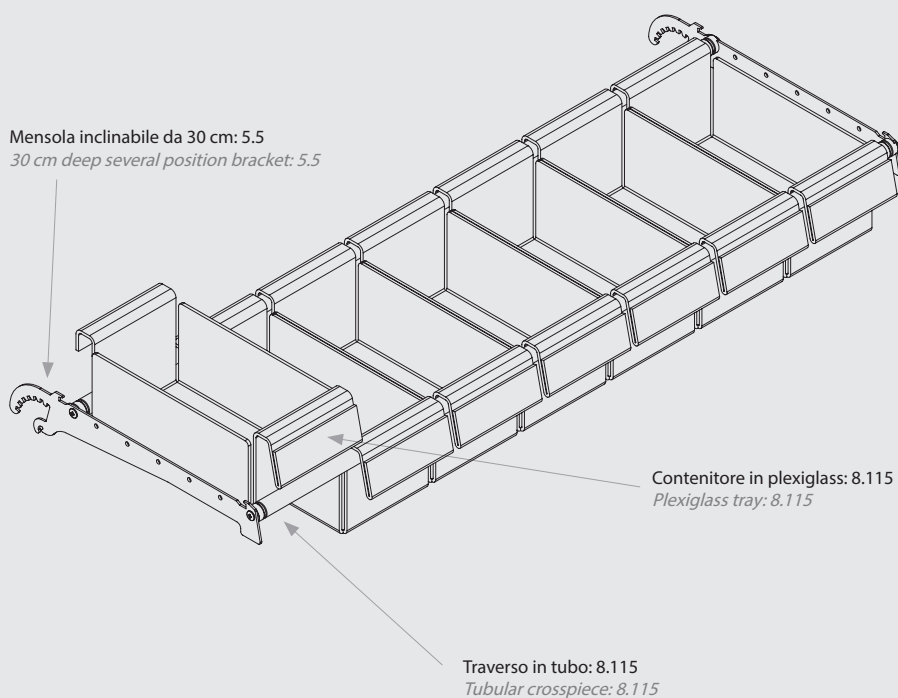

Espositori  
Displays

8.115

Contenitore in plexiglass / per posate  
Plexiglass cutlery tray

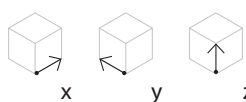
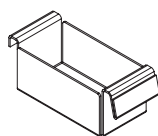

x y z

codice  
code

finitura e  
colore  
finish &  
colour

note  
notes

13,8 25 11 22.425 N

Traverso in tubo  $\varnothing$  2 cm  
Tubular crosspiece  $\varnothing$  2 cm with screws

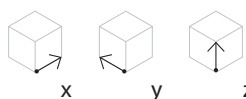

x y z

codice  
code

finitura e  
colore  
finish &  
colour

note  
notes

99 -- -- 22.424 C

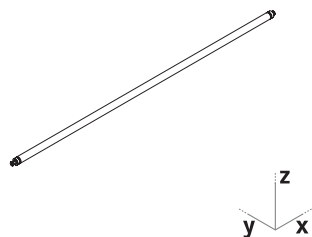

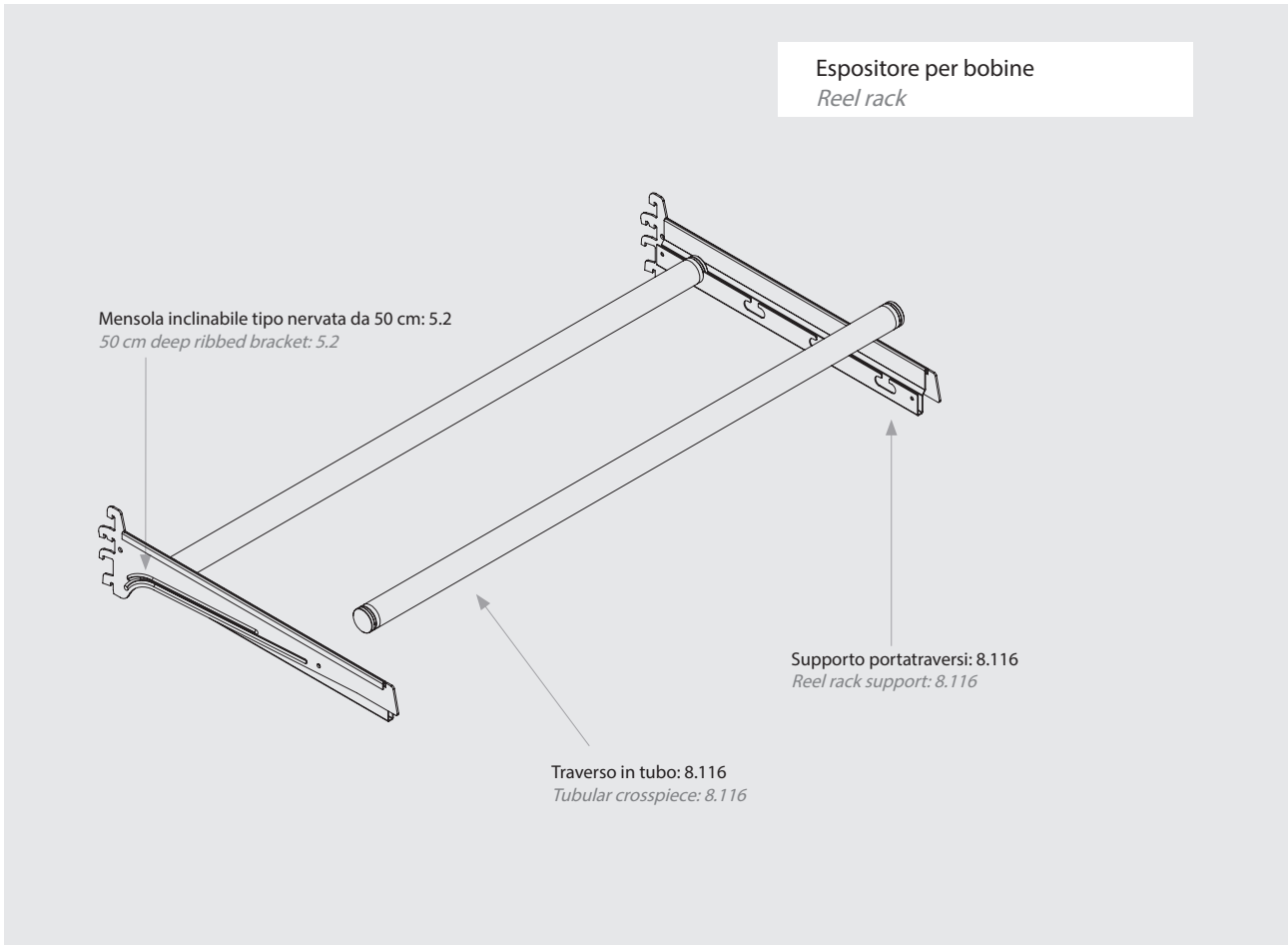

**Espositori / Displays** **8.116** **Supporto porta traversi per mensola da 50 cm / per bobine / Reel rack support for 50 cm deep brackets**

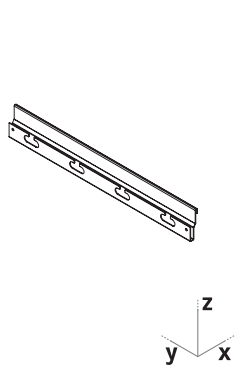

x	y	z	codice code	note notes
--	49	--	22.428	

finitura finish	colori colours
V	2004
	6018
	6027
	• 7035
	AMA
	• ANT
	AZZ
	1001
	• BIA
	BLU
	GIA
	MAR
	• MTZ
	• PAN
	RO3
	BIMCL
	NRMCL
	• OXI

**Traverso in tubo ø 2,5 cm / Tubular crosspiece ø 2,5 cm**

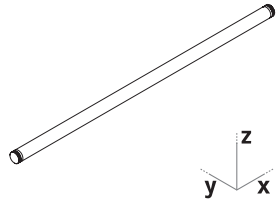

x	y	z	codice code	finitura e colore finish & colour	note notes
100	--	--	22.429	C	

Espositore per pneumatici/bobine  
Tyre rack/

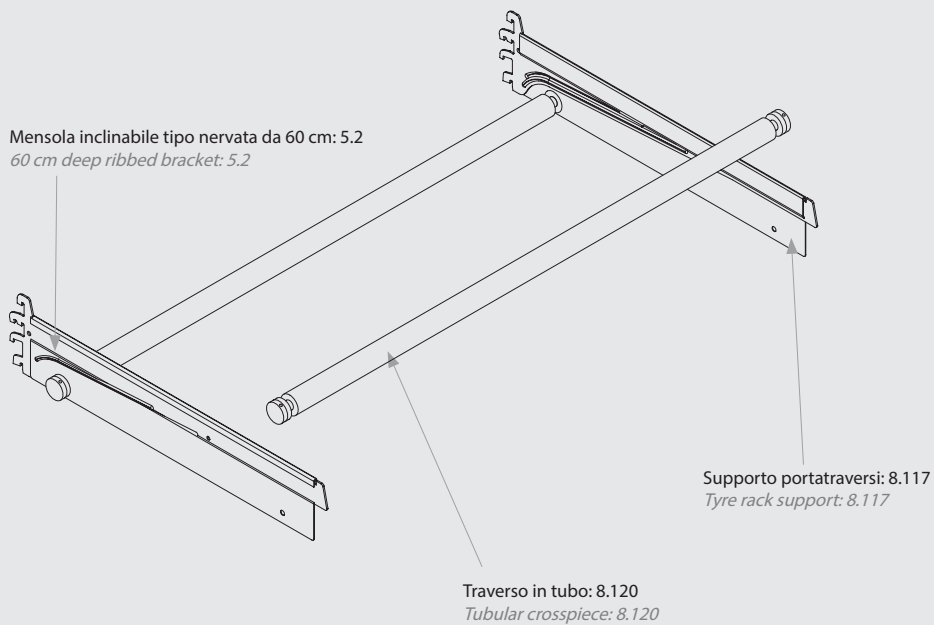

Espositore per biciclette  
Bicycle rack

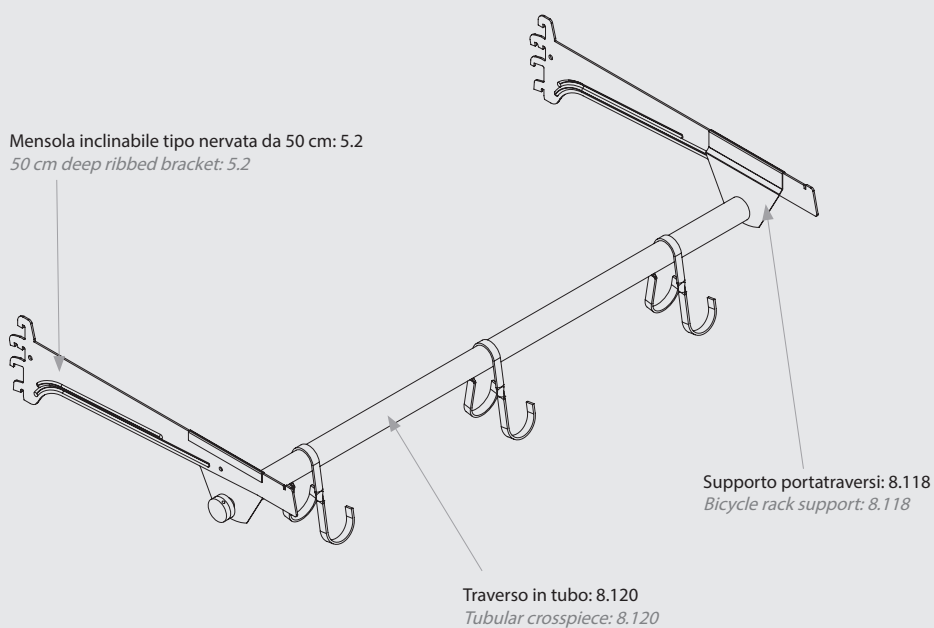



8.117

Supporto laterale porta traversi per mensola da 60 cm per pneumatici  
*Tyre rack support for 60 cm deep brackets*

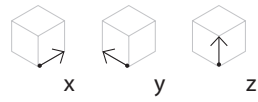
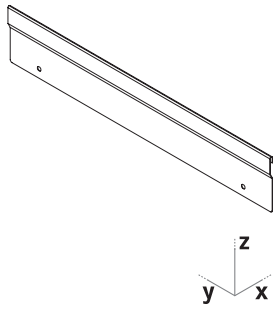

	x	y	z	codice code	finitura e colore finish & colour	note notes
	--	60	--	34.332	C	



8.118

Supporto laterale porta traversi per mensola da 50 cm per biciclette  
*Bicycle rack support for 50 cm deep brackets*

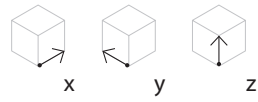
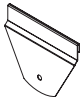

	x	y	z	codice code	finitura e colore finish & colour	note notes
	--	--	--	34.331	C	



8.119

Gancio / per biciclette  
*Bicycle holder hook*

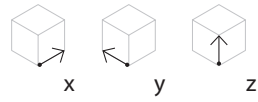

	x	y	z	codice code	finitura e colore finish & colour	note notes
	--	--	--	34.-37	C	



8.120

Traverso in tubo  $\varnothing$  3,5 cm  
*Tubular crosspiece  $\varnothing$  3,5 cm*

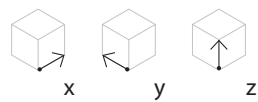
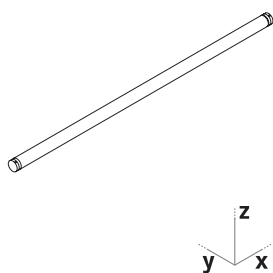

	x	y	z	codice code	finitura e colore finish & colour	note notes
	50	--	--	34.506	C	
	66,5	--	--	34.507	C	
	75	--	--	34.508	C	
	100	--	--	34.329	C	
	133	--	--	34.330	C	

# Espositore inclinato

## *Sloping display*

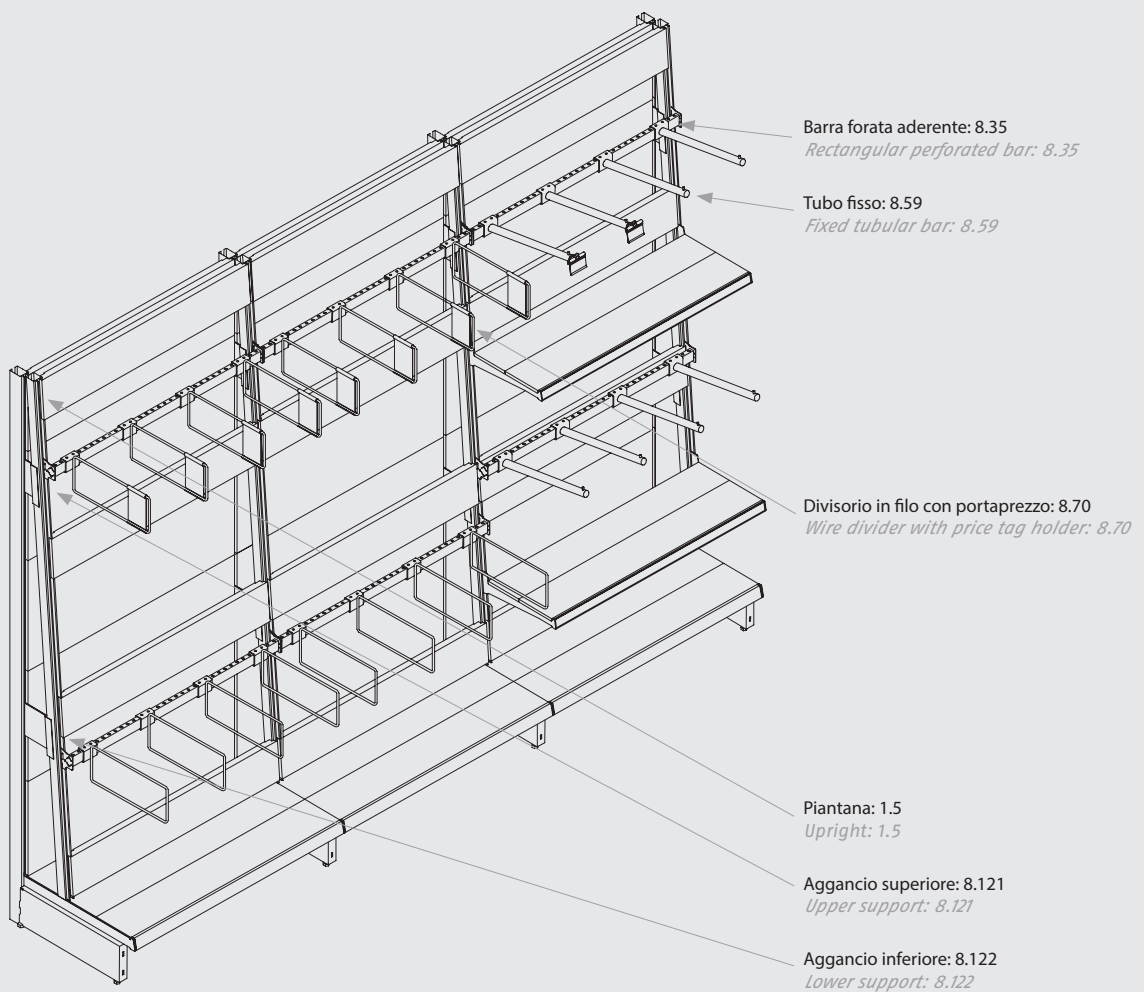





Espositori  
Displays

8.121

Aggancio superiore per piantana inclinata / per listelli  
Upper support for sloped additional upright

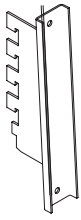

	x	y	z	codice code	note notes
piantana upright y=5	4,2	7,8	25	16.191	

finitura finish	colori colours
V	2004
	6018
	6027
	• 7035
	AMA
	• ANT
	AZZ
	1001
	• BIA
	BLU
	GIA
	MAR
	• MTZ
	• PAN
	RO3
	BIMCL
	NRMCL
	• OXI



Espositori  
Displays

8.122

Aggancio inferiore per piantana inclinata / per listelli  
Lower support for sloped additional upright

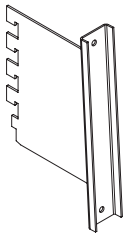

	x	y	z	codice code	note notes
piantana upright y=5	4,2	14,8	25	16.192	

finitura finish	colori colours
V	2004
	6018
	6027
	• 7035
	AMA
	• ANT
	AZZ
	1001
	• BIA
	BLU
	GIA
	MAR
	• MTZ
	• PAN
	RO3
	BIMCL
	NRMCL
	• OXI



Espositori  
Displays

8.123

Accessori per agganci per piantana inclinata  
Accessories for supports for sloped upright

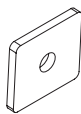

Piastrina con foro x=3 z=2,7 cm  
Plate with hole x=3 z=2,7 cm

codice code	finitura e colore finish & colour
11.-78	C

Vite flangiata  $\varnothing 0,6$  y=2 cm con dado  
Flanged screw  $\varnothing 0,6$  y=2 cm with nut

34.519	C
--------	---

# Espositore a telai scorrevoli

## *Sliding frame*

Esempi di impiego dei telai scorrevoli su basi h 17 e 23  
*Sliding frame setting with 17 / 23 cm high bases*

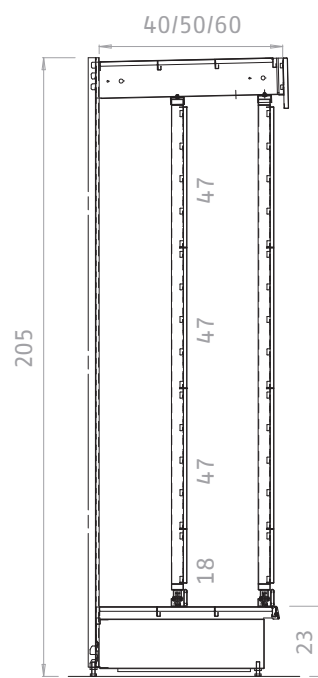
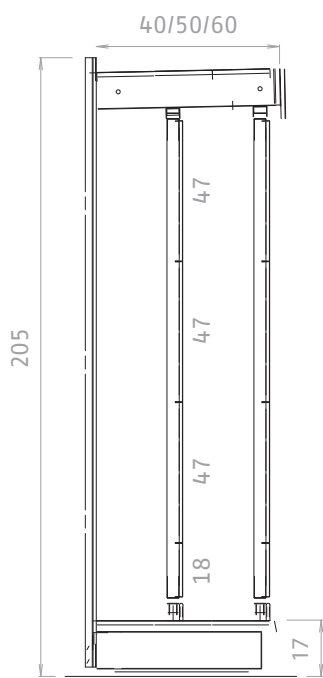

Esempi di impiego con telai scorrevoli da 50  
*50 cm wide sliding frame setting*

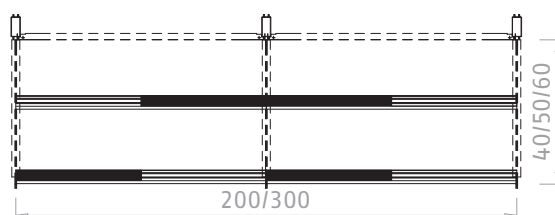

Esempi di impiego con telai scorrevoli da 75  
*75 cm wide sliding frame setting*

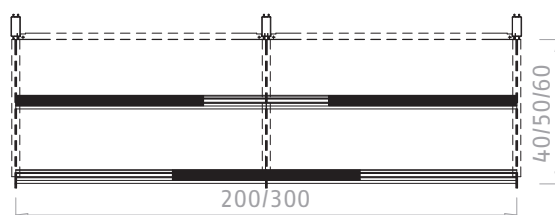

Utilizzo dei pannelli di fondale  
*Back panels setting*

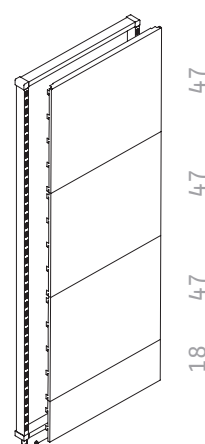

# Espositore a telai scorrevoli

## *Sliding frame*

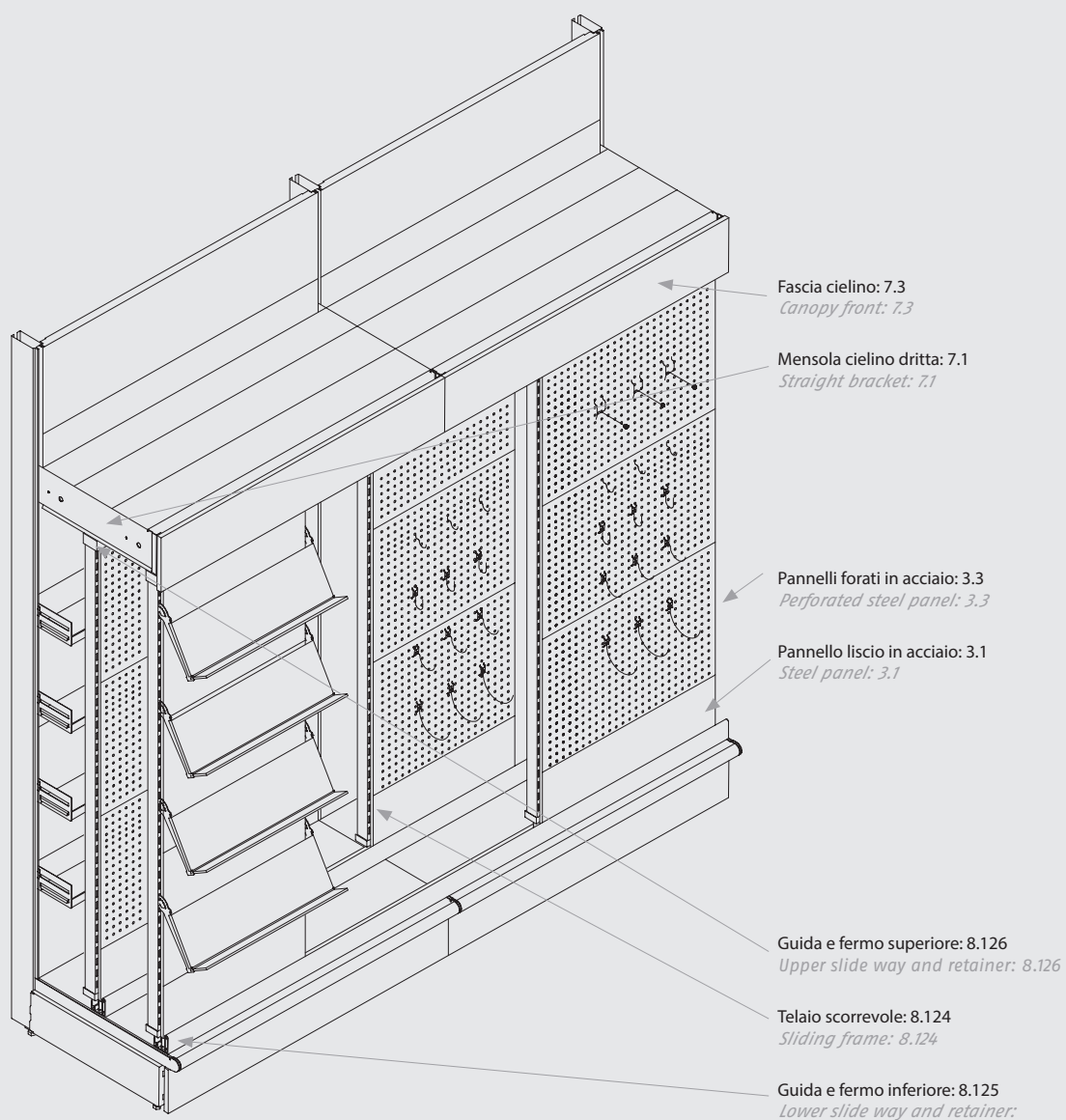

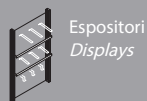

Espositori  
Displays

8.124

Telaio scorrevole  
Sliding frame

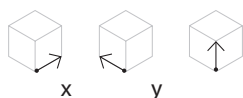
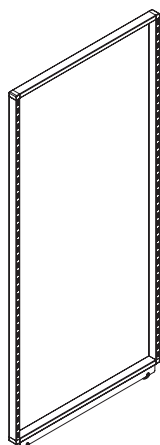

x	y	z	codice code	note notes
50	4	168	22.415	
75	4	168	22.414	

portata max 100Kg

finitura finish	colori colours
V	2004
	6018
	6027
	• 7035
	AMA
	• ANT
	AZZ
	1001
	• BIA
	BLU
	GIA
	MAR
	• MTZ
	• PAN
	RO3
	BIMCL
	NRMCL
	• OXI

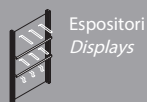

Espositori  
Displays

8.125

Guida inferiore per telaio scorrevole  
Lower slide way for sliding frame

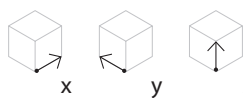
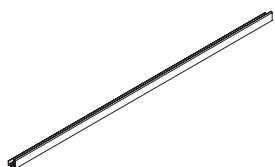

x	y	z	codice code	note notes
200	6	6	22.416	
300	6	6	22.417	

finitura finish	colori colours
V	2004
	6018
	6027
	• 7035
	AMA
	• ANT
	AZZ
	1001
	• BIA
	BLU
	GIA
	MAR
	• MTZ
	• PAN
	RO3
	BIMCL
	NRMCL
	• OXI

Fermo inferiore per telaio scorrevole  
Lower retainer for sliding frame

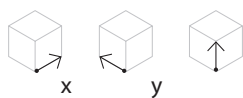

x	y	z	codice code	finitura e colore finish & finish & colour	note notes
5	--	1,5	22.421	C	



8.126

Guida superiore per telaio scorrevole  
Upper slide way for sliding frame

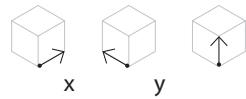
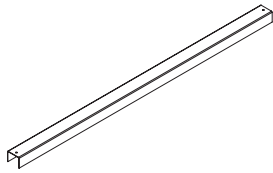

	x	y	z	codice code	note notes
base base z=17	100	4,5	3,5	22.418	
base base z=23	100	4,5	2,5	22.419	

finitura finish	colori colours
V	2004
	6018
	6027
	• 7035
	• AMA
	• ANT
	AZZ
	1001
	• BIA
	BLU
	GIA
	MAR
	• MTZ
	• PAN
	RO3
	BIMCL
	NRMCL
	• OXI

Fermo terminale superiore per telaio scorrevole  
Upper retainer for sliding frame

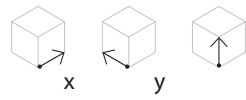

	x	y	z	codice code	note notes
	4,6	4	2,5	22.420	

finitura finish	colori colours
V	2004
	6018
	6027
	• 7035
	• AMA
	• ANT
	AZZ
	1001
	• BIA
	BLU
	GIA
	MAR
	• MTZ
	• PAN
	RO3
	BIMCL
	NRMCL
	• OXI

# Espositore testata Podio

## *Podium head components*

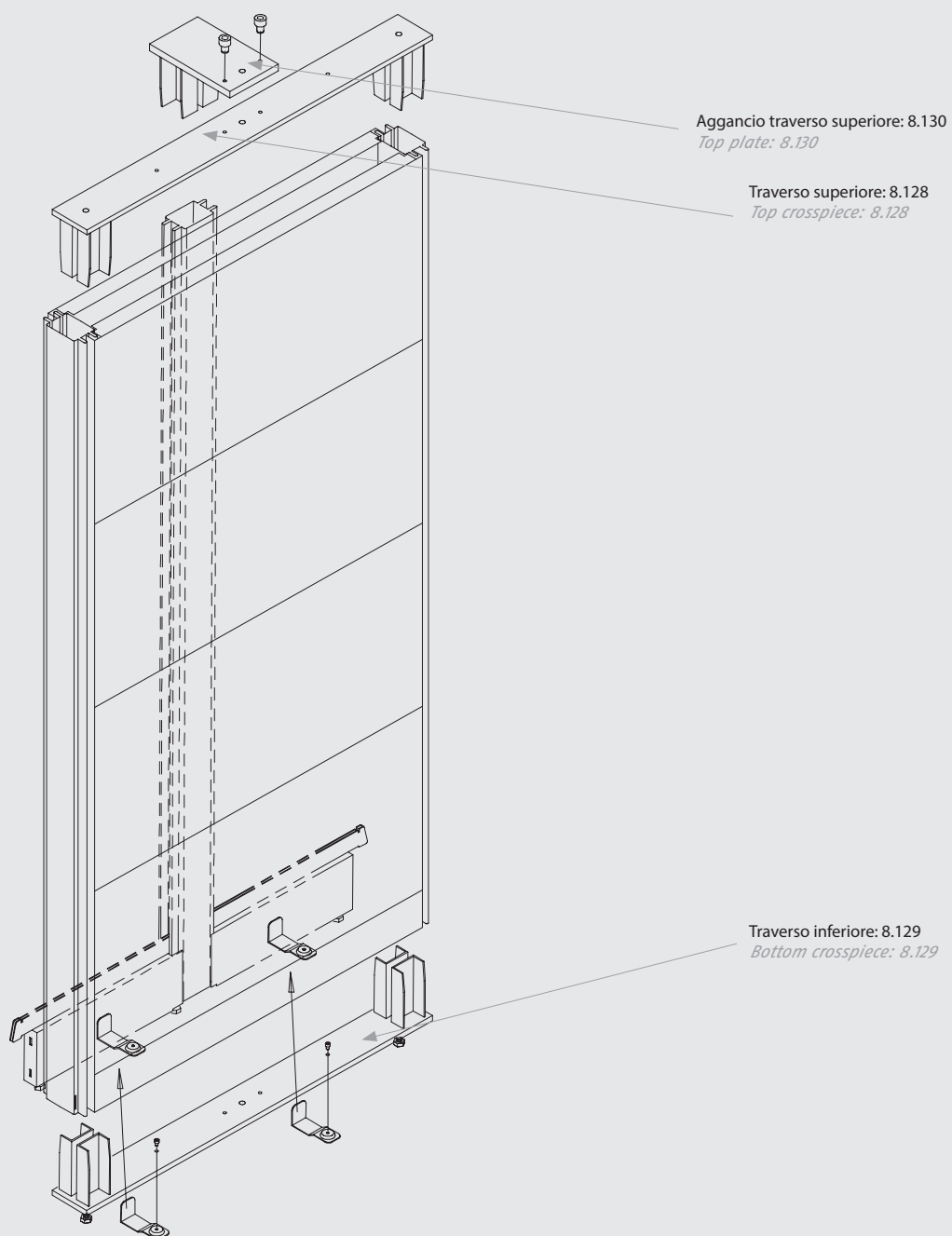



8.127

Coperchio pedana Podio  
Top for promotional head gondola Podium

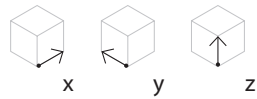
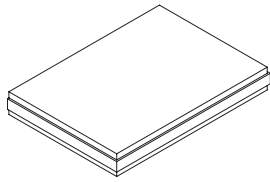

	x	y	z	codice code
100	72	13	29.129	
133	72	13	29.130	

note notes

finitura finish

colori colours

colori colours

finitura finish	colori colours	colori colours
V	2004	MAR
	6018	• MTZ
	6027	• PAN
	• 7035	RO3
	AMA	BIMCL
	• ANT	NRMCL
	AZZ	• OXI
	1001	
	• BIA	
	BLU	
	GIA	



8.128

Traverso superiore testata Podio  
Top crosspiece for Podium head

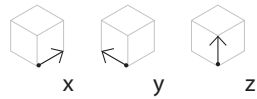
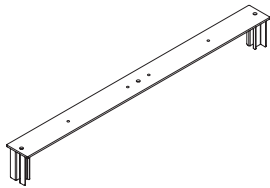

	x	y	z	codice code
100	--	--	34.325	
133	--	--	34.323	

note notes

finitura finish

colori colours

colori colours

per piantana tub. da 9  
for tubular upright 9 cm

finitura finish	colori colours	colori colours
V	2004	MAR
	6018	• MTZ
	6027	• PAN
	• 7035	RO3
	AMA	BIMCL
	• ANT	NRMCL
	AZZ	• OXI
	1001	
	• BIA	
	BLU	
	GIA	



8.129

Traverso inferiore testata Podio  
Bottom crosspiece for Podium head

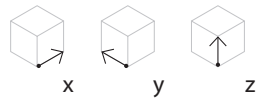
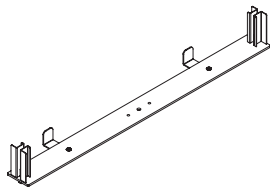

	x	y	z	codice code
100	--	--	34.326	
133	--	--	34.324	

note notes

finitura finish

colori colours

colori colours

per piantana tub. da 9  
for tubular upright 9 cm

finitura finish	colori colours	colori colours
V	2004	MAR
	6018	• MTZ
	6027	• PAN
	• 7035	RO3
	AMA	BIMCL
	• ANT	NRMCL
	AZZ	• OXI
	1001	
	• BIA	
	BLU	
	GIA	

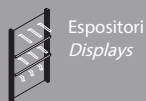

8.130

Aggancio traverso superiore testata Podio per piantane tubolari  
Top plate for Podium head for tubular upright

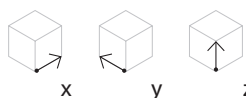
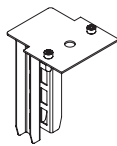

	x	y	z	codice code	note notes
piantana upright y=9	--	--	--	34.337	
piantana upright y=12	--	--	--	34.335	

finitura finish	colori colours
V	2004
	6018
	6027
	• 7035
	AMA
	• ANT
	AZZ
	1001
	• BIA
	BLU
	GIA
	MAR
	• MTZ
	• PAN
	RO3
	BIMCL
	NRMCL
	• OXI



# Fondale rete centrale

## *Display with central grid*

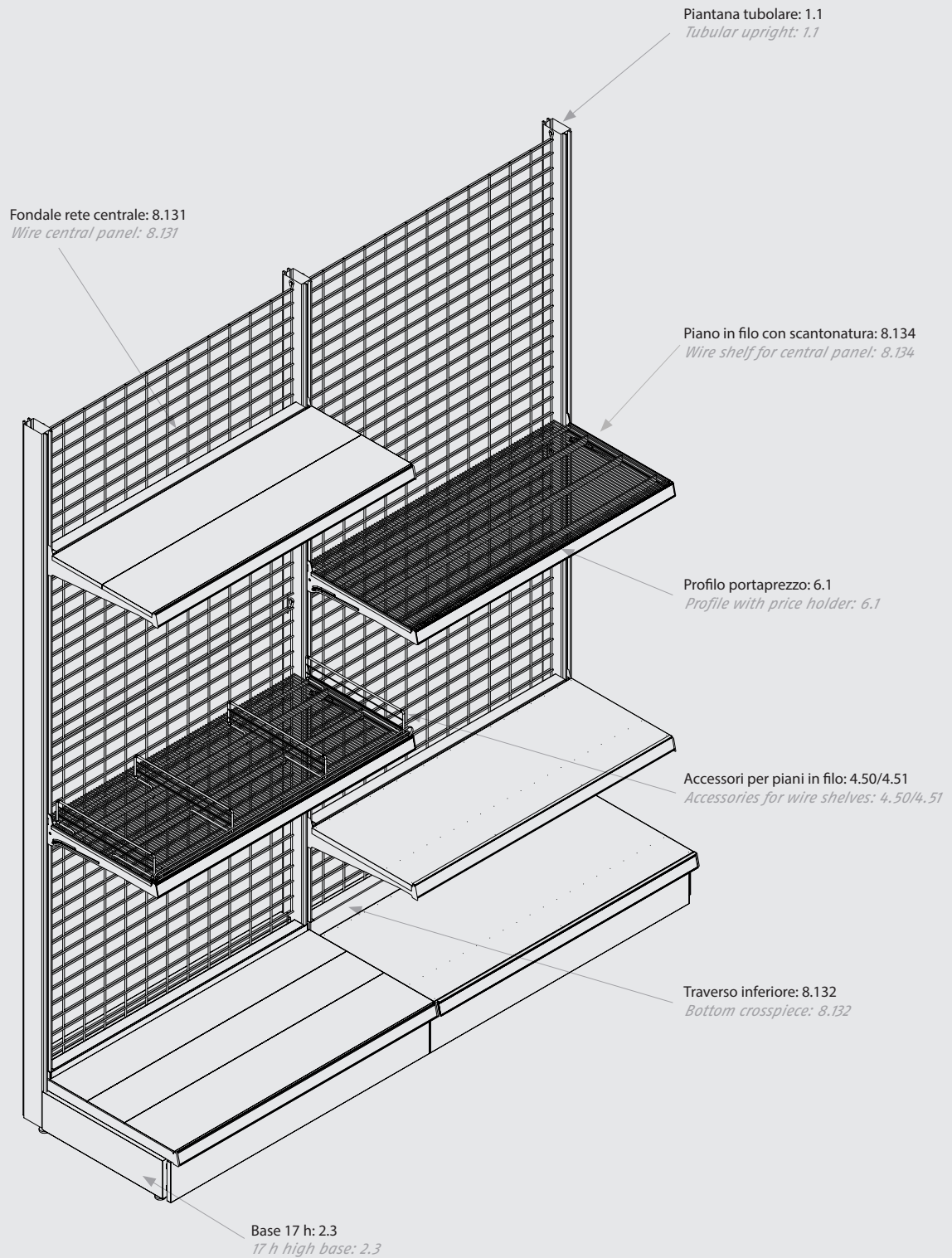

# Gondola con fondale centrale

## *Gondola with central panel*

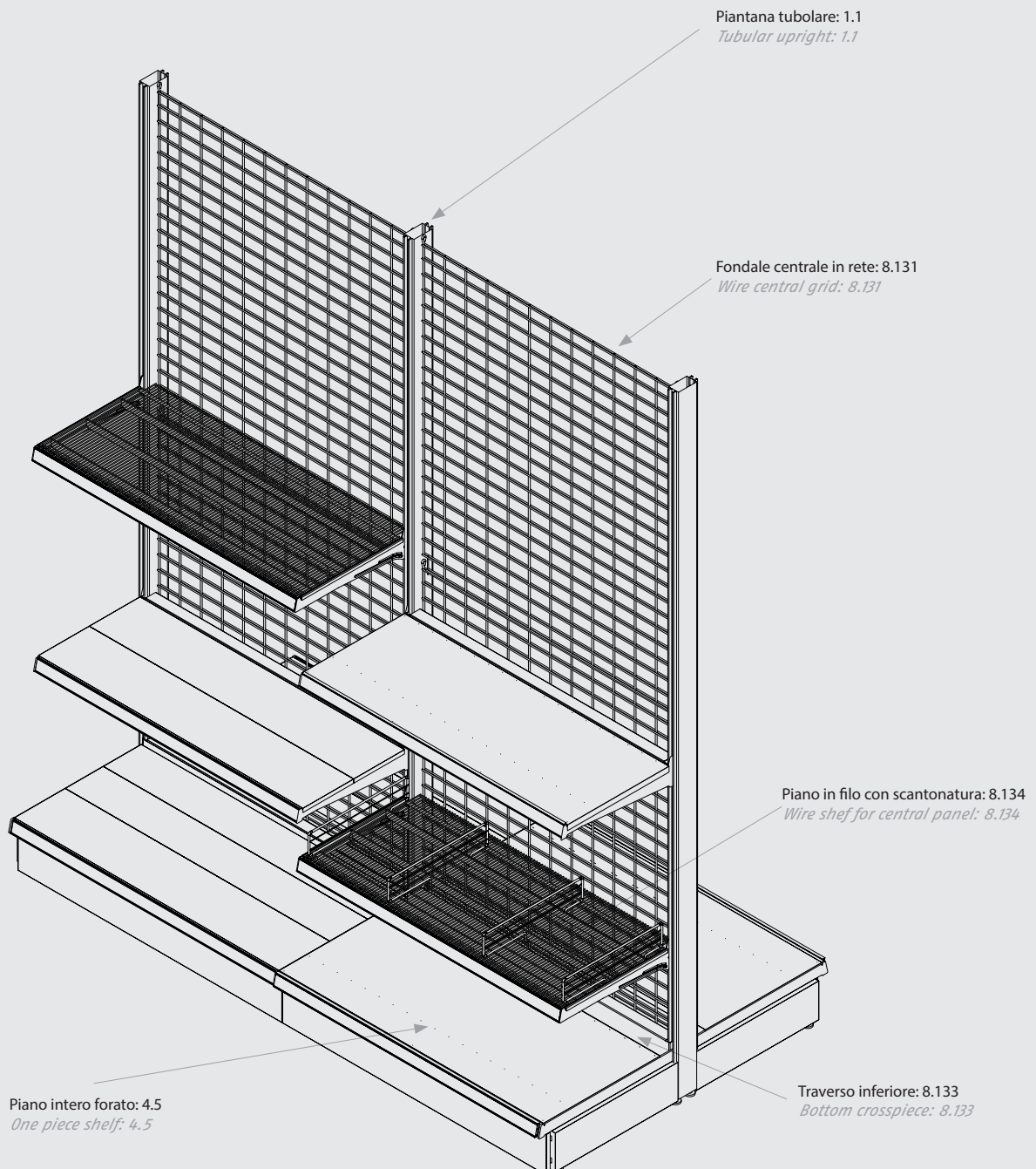

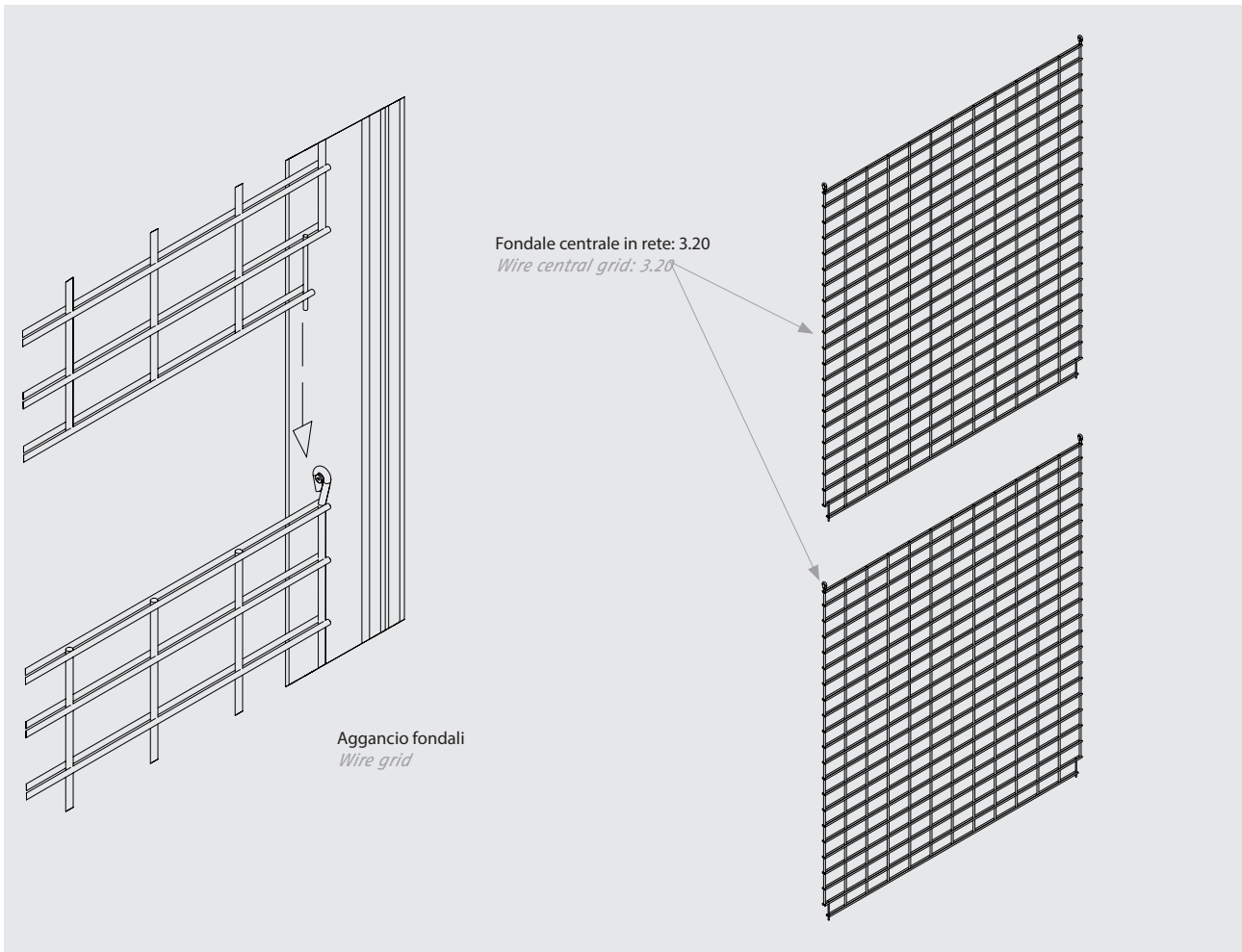

Espositori  
Displays

8.131

Fondale centrale in rete con maglia 10x5  
Central grid panel with 10x5 cm

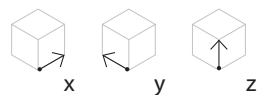
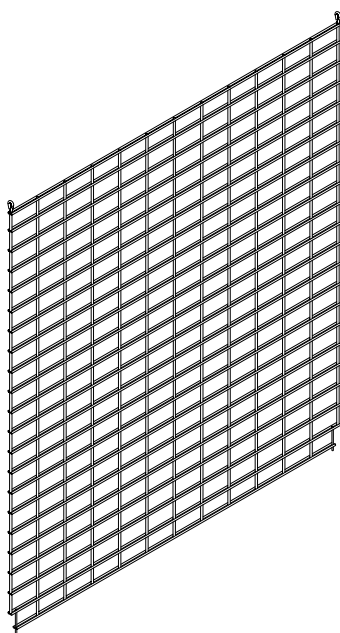

x	y	z	codice code	note notes
66,5	1	158	13.598	X 1
66,5	1	205	13.632	X 2
66,5	1	234	13.630	X 2
100	1	158	13.596	X 1
100	1	205	13.634	X 2
100	1	234	13.592	X 2
133	1	158	13.597	X 1
133	1	205	13.633	X 2
133	1	234	13.591	X 2

finitura finish	colori colours
V	
	2004
	6018
	6027
	• 7035
	AMA
	• ANT
	AZZ
	1001
	• BIA
	BLU
	GIA
	MAR
	• MTZ
	• PAN
	RO3
	BIMCL
	NRMCL
	• OXI

nr. 2 viti autopерforanti: 34.521C  
nr. 2 screws each wire grid: 34.521C





Espositori  
Displays

8.132

Traverso inferiore per elementi a parete con fondale centrale  
*Bottom crosspiece for wall unit with central panel*

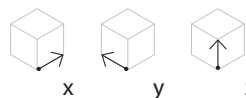
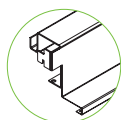
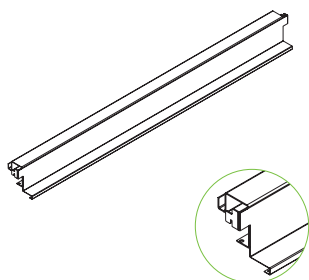

	x	y	z	codice code	note notes	finitura finish	colori colours	colori colours
100	--	--	--	34.678		V		
133	--	--	--	34.679			2004	MAR
							6018	• MTZ
							6027	• PAN
							• 7035	RO3
							AMA	BIMCL
							• ANT	NRMCL
							AZZ	• OXI
							1001	GIA
							• BIA	
							BLU	

per piantana tub. da 9  
for tubular upright 9 cm

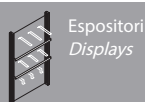

Espositori  
Displays

8.133

Traverso inferiore per elementi a gondola con fondale centrale  
*Bottom crosspiece for gondola unit with central panel*

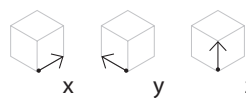
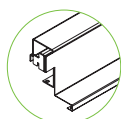
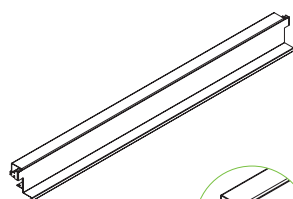

	x	y	z	codice code	note notes	finitura finish	colori colours	colori colours
100	--	--	--	34.611		V		
133	--	--	--	34.630			2004	MAR
							6018	• MTZ
							6027	• PAN
							• 7035	RO3
							AMA	BIMCL
							• ANT	NRMCL
							AZZ	• OXI
							1001	GIA
							• BIA	
							BLU	

per piantana tub. da 9  
for tubular upright 9 cm

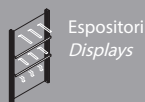

Espositori  
Displays

8.134

Piano in filo con scantonatura per fondale centrale  
*Wire shelf for central grid panel*

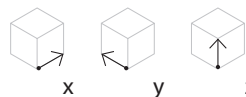
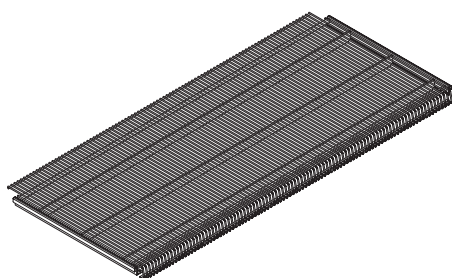

	x	y	z	codice code	note notes	finitura finish	colori colours	colori colours
100	30	4	4	22.528		V		
133	30	4	4	22.531			2004	MAR
							6018	• MTZ
							6027	• PAN
							• 7035	RO3
							AMA	BIMCL
							• ANT	NRMCL
							AZZ	• OXI
							1001	GIA
							• BIA	
							BLU	
100	50	4	4	22.530				
133	50	4	4	22.533				

Profilo: 6.1  
Profile: 6.1



Espositori  
Displays

8.134

Elemento di compensazione fondale centrale per ripiani a liste e interi  
Compensation support for central backpanel for one piece or plank shelves

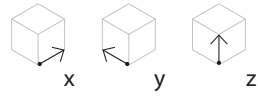
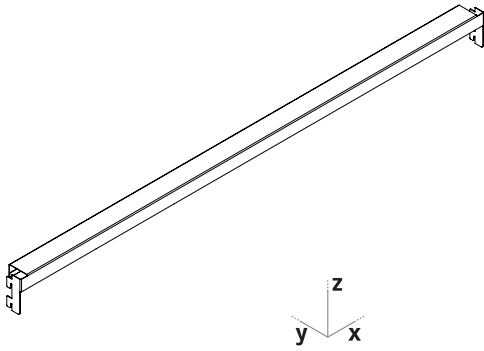

	x	y	z	codice code	note notes
	100	4		40.191	
	66,5	4		40.190	
	133	4		40.192	

finitura finish	colori colours
V	
	2004
	6018
	6027
	• 7035
	AMA
	• ANT
	AZZ
	1001
	• BIA
	BLU
	GIA
	MAR
	• MTZ
	• PAN
	RO3
	BIMCL
	NRMCL
	• OXI

**note**  
*notes*

**note**  
*notes*

# Vetrine e mobili base

## *Glass and base cabinets*

# 9

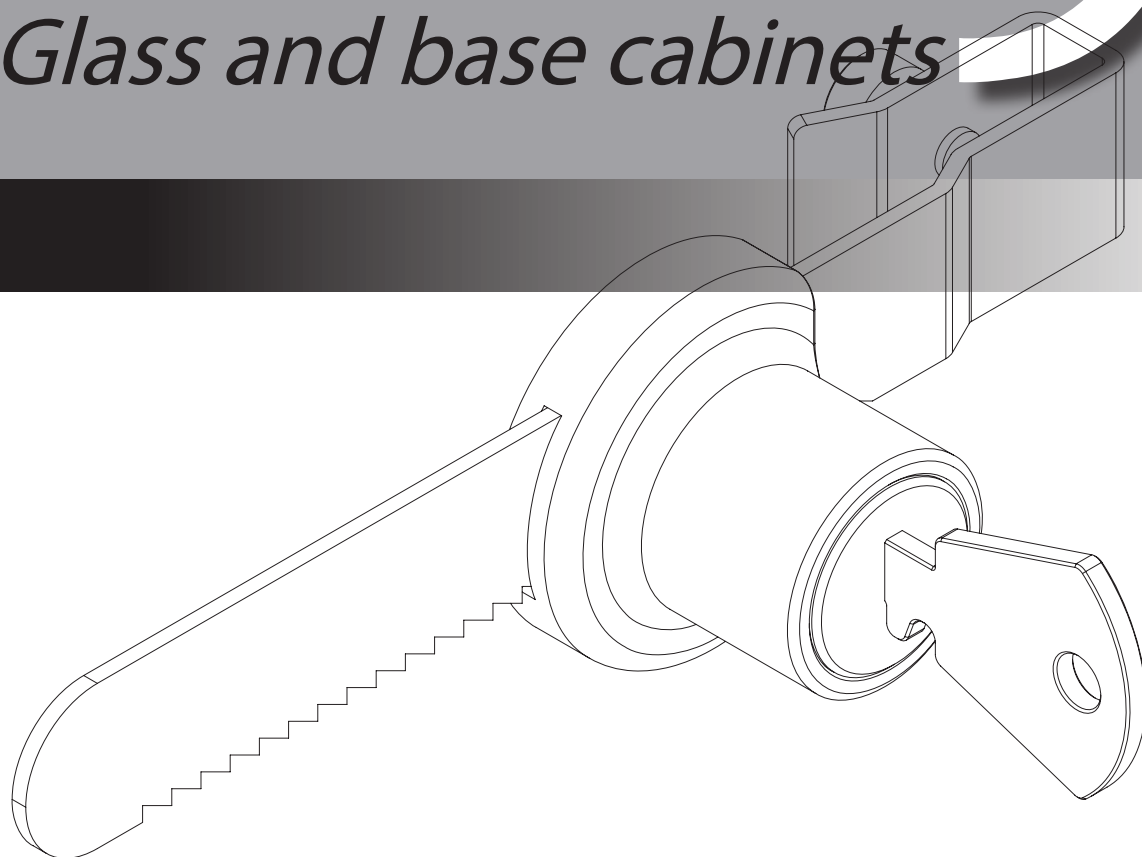

Vetrine pensili, vetrine componibili, mobili base con cassetti, mobili base con ante scorrevoli, mobili base componibili.

*Hanging showcases, sloped showcase units, base cabinets with drawers, base cabinets with sliding doors, modular base cabinets.*





Vetrina h 234 con spalle in legno  
Showcase h 234 with wooden side panels

Guida superiore: 9.14  
Upper slide way: 9.14

Spalla laterale: 9.11  
Side panel: 9.11

Antina in vetro: 9.15  
Glass sliding door: 9.15

Guida inferiore e terminale: 9.13  
Lower slide way and end piece: 9.13

Fermo inferiore: 9.16  
Lower retainer: 9.16

Spalla laterale aperta: 9.12  
Open side panel: 9.12

Antina in vetro: 9.15  
Glass sliding door: 9.15

Fermo inferiore: 9.16  
Lower retainer: 9.16

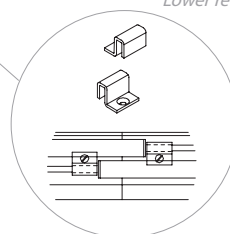
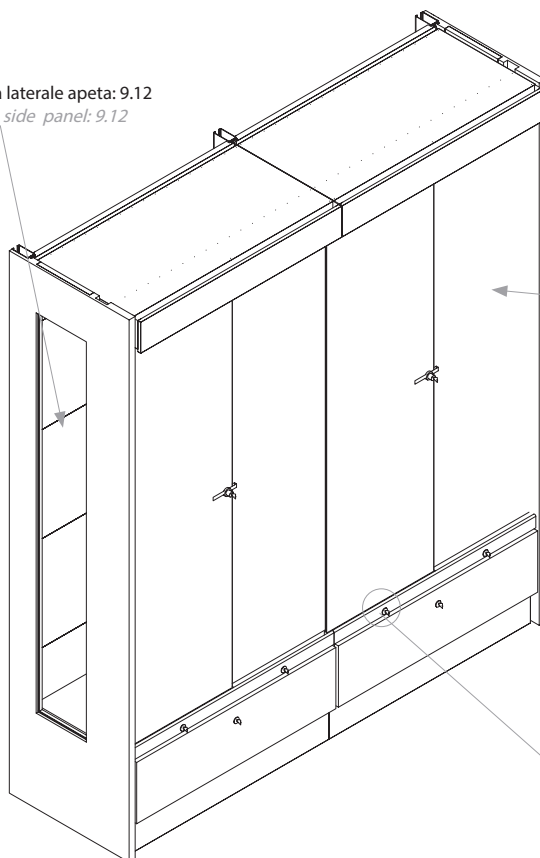
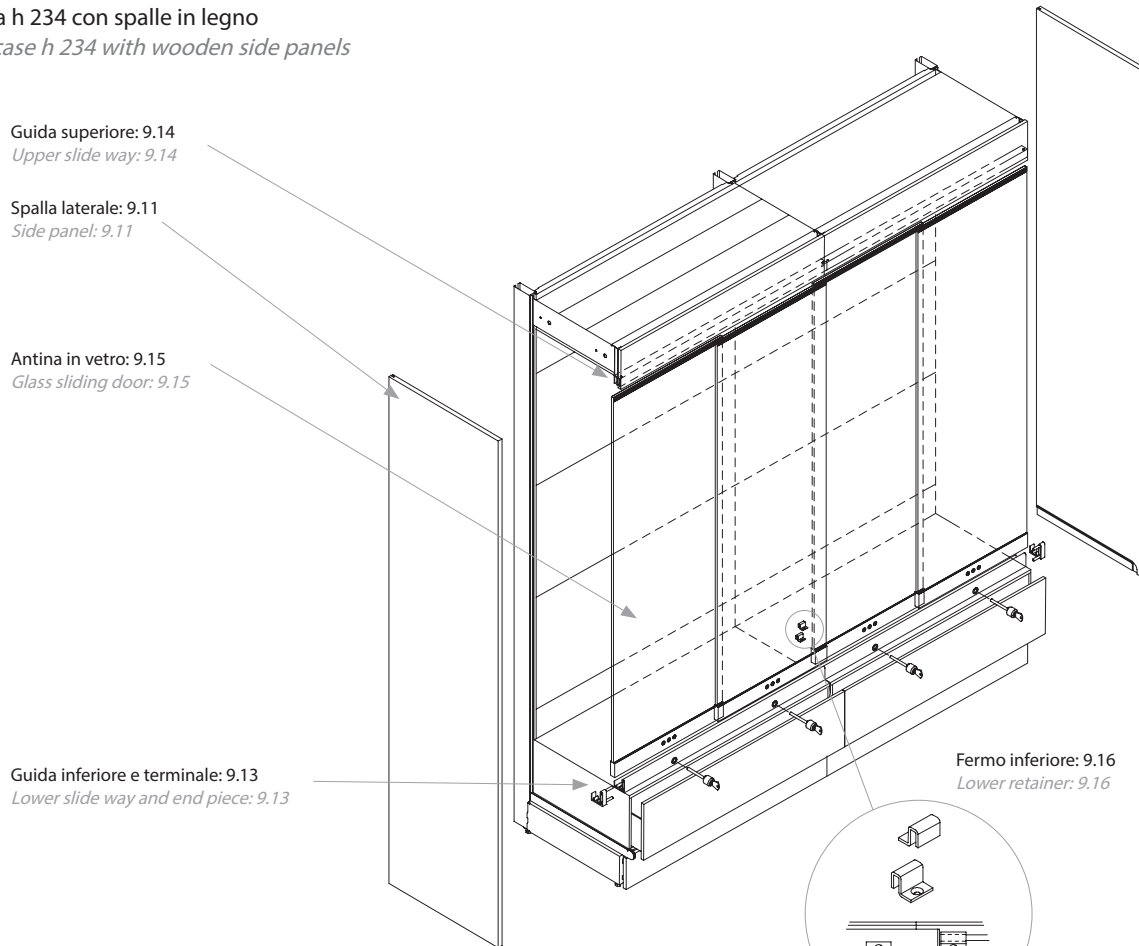

Esempi di impiego delle vetrine e dei mobili base su basi h 17 | misura delle antine in vetro  
*Showcase and base cabinets setting with 17 cm high bases | glass sliding door measurements*

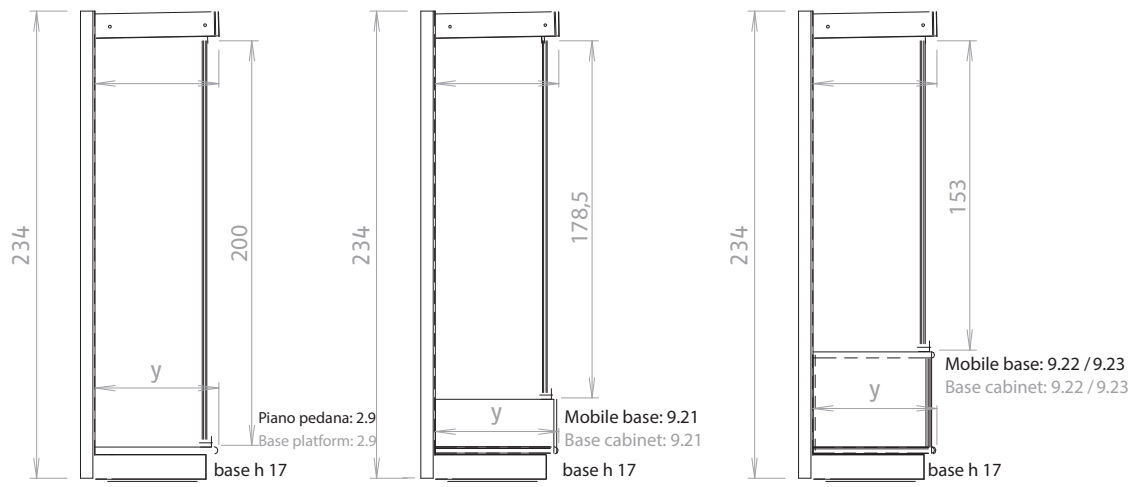

**Vetrina inclinata h 98 con spalla metallo e top legno**  
*Sloped showcase h 98 with wooden side panel and upper wooden shelf*

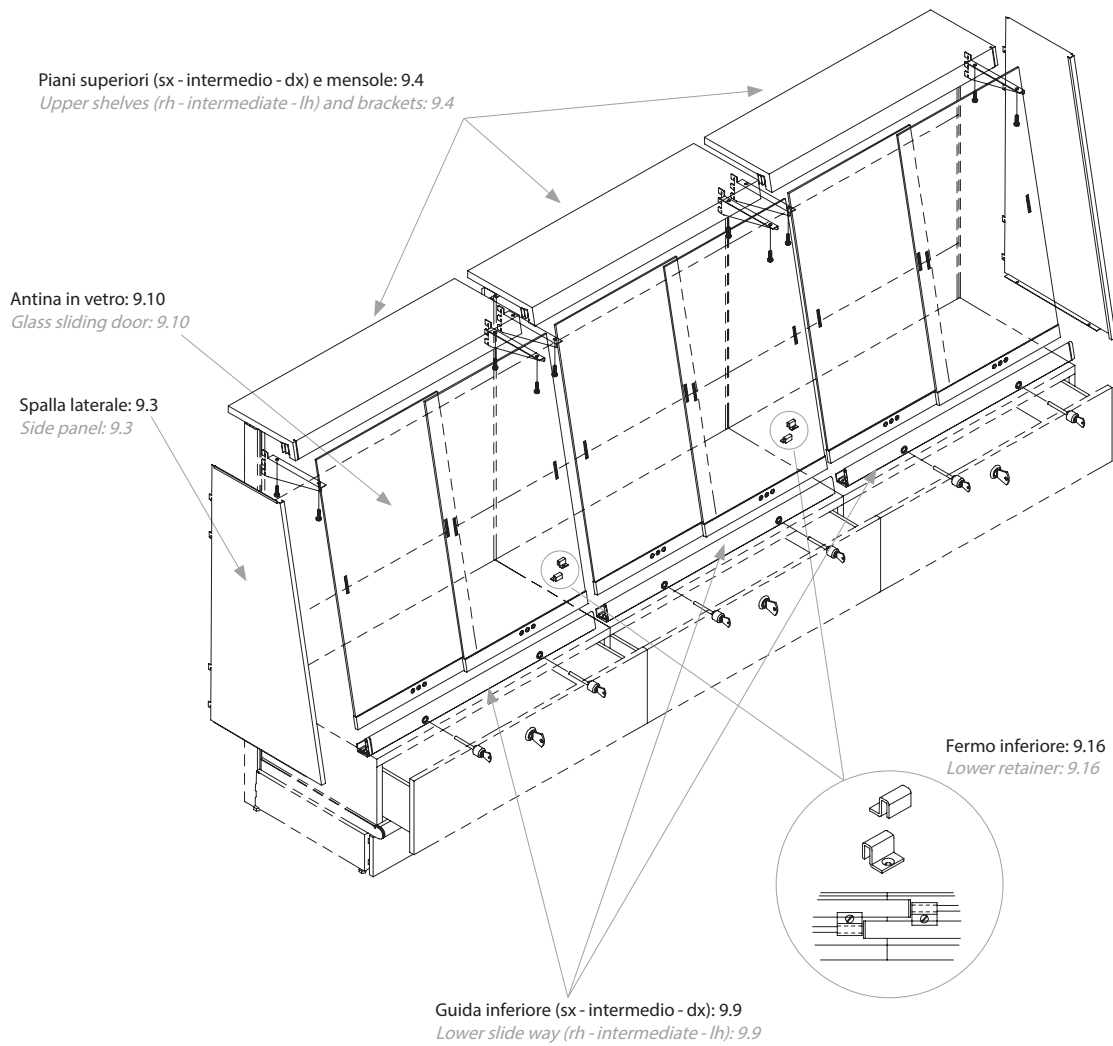

Piano superiore (singolo) e mensole: 9.4  
*Upper shelf (single) and brackets: 9.4*

Antina in vetro: 9.10  
*Glass sliding door: 9.10*

Spalla laterale: 9.3  
*Side panel: 9.3*

Serratura: 9.17  
*Lock with key: 9.17*

Guida inferiore (singola): 9.9  
*Lower slide way (single): 9.9*

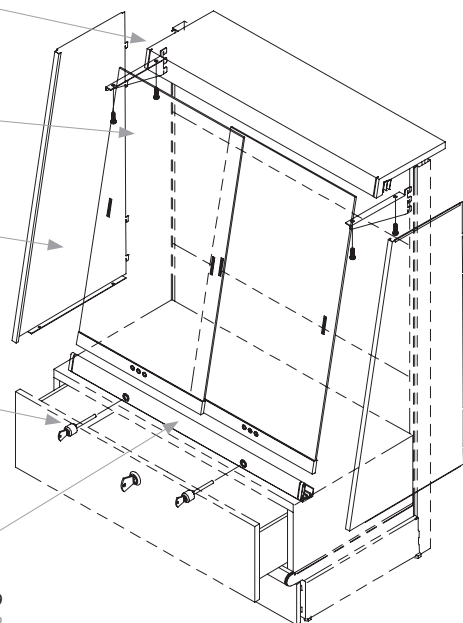

**Vetrina inclinata h 98 con spalla e top in vetro**

*Sloped showcase h 98 with side glass panel and frame supportig glass top*

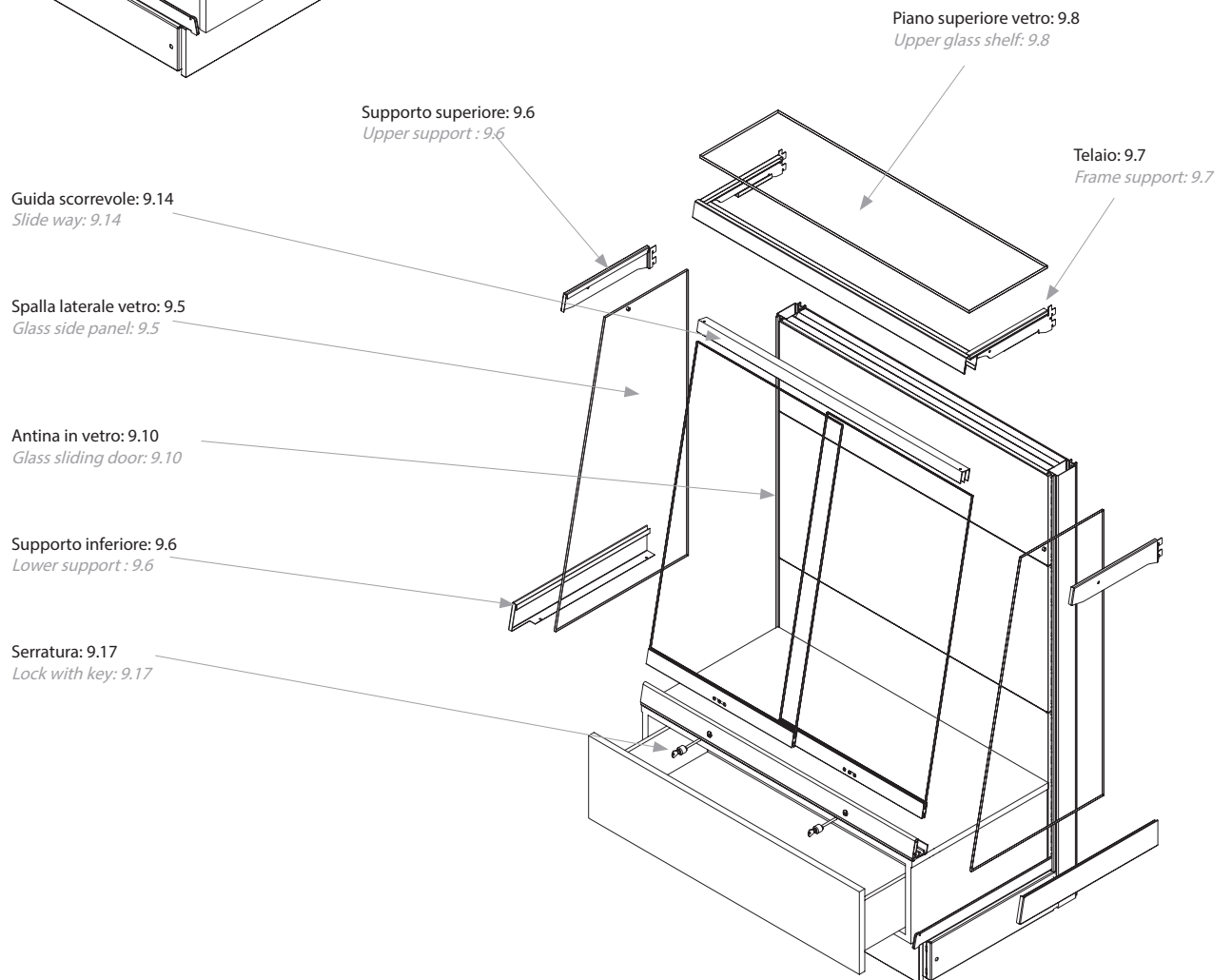
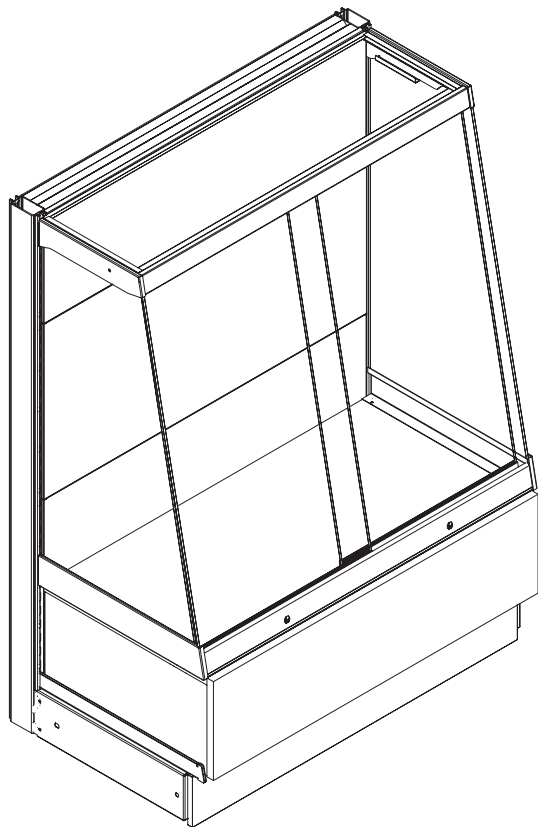

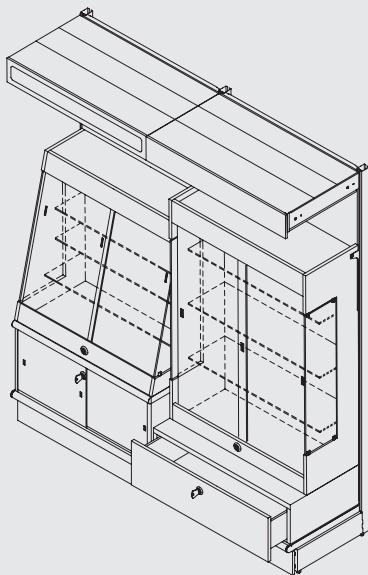

Composizione con vetrine pensili  
*Hanging showcase setting*

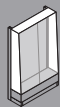

Vetrine  
*Glass Cabinets*

9.1

Vetrina pensile ad ante verticali in vetro temperato con serratura  
*Hanging tempered glass showcase with lock*

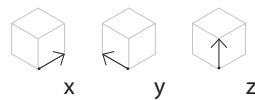
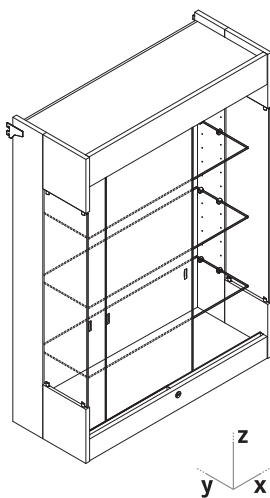

x      y      z      codice code

100    39    140    22.520

note notes

finitura finish

colori colours

colori colours

T		
•	7035	A838
•	ACE	999XA
•	BIA	995XM
	FAG	989XR
•	MTZ	994XS
•	PAN	997XS
•	A439	983XR
•	ANT	984XA
	K101	BLACK
	3813	GREEN
	2293	BEIGE
	990XA	WHITE
	990XM	

Completa di 3 piani  
vetro trasparenti  
(27 cm di profondità)  
*It includes*  
3 transparent glass  
shelves (27 cm deep)

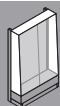

Vetrine  
*Glass Cabinets*

9.2

Vetrina pensile ad ante inclinate in vetro temperato con serratura  
*Sloped hanging tempered glass showcase with lock*

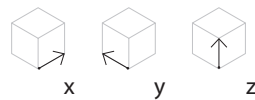
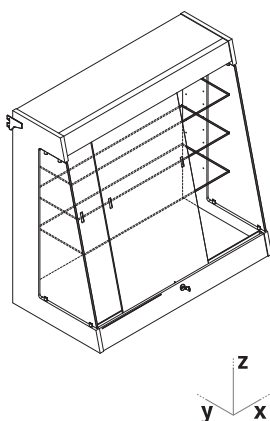

x      y      z      codice code

100    50    96    22.609

note notes

finitura finish

colori colours

colori colours

T		
•	7035	A838
•	ACE	999XA
•	BIA	995XM
	FAG	989XR
•	MTZ	994XS
•	PAN	997XS
•	A439	983XR
•	ANT	984XA
	K101	BLACK
	3813	GREEN
	2293	BEIGE
	990XA	WHITE
	990XM	

Completa di 3 piani  
vetro trasparenti  
(20 / 20 / 27 cm  
di profondità)  
*It includes*  
3 transparent glass  
shelves  
(20 / 20 / 27 cm deep)



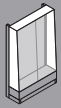

Vetrine  
Glass Cabinets

9.5

Spalla laterale dx/sx in vetro temprato per vetrina H 234  
Tempered side glass panel dx/sx for sloped showcase h 234

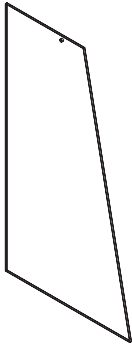

	x	y	z	codice code	finitura e colore finish & colour	note notes
dx rh	--	48	98	22.494	NT	
sx lh	--	48	98	22.494	NT	

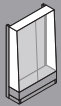

Vetrine  
Glass Cabinets

9.6

Supporto sup. ed inf. per spalla in vetro per vetrina inclinata h 98  
Support up. and low. for glass side panel for sloped showcase h 98

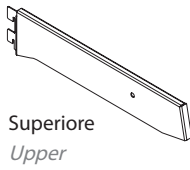

	x	y	z	codice code	note notes	finitura finish	colori colours
dx rh	--	33	6	34.571		V	2004
sx lh	--	33	6	34.572			6018
							6027
							• 7035
							AMA
							• ANT
							AZZ
							1001
							• BIA
							BLU
							GIA
							MAR
							• MTZ
							• PAN
							RO3
							BIMCL
							NRMCL
							• OXI

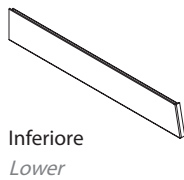

	x	y	z	codice code	note notes
dx rh	--	51	6	16.377	
sx lh	--	51	6	16.378	



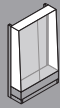

Vetrine  
Glass Cabinets

9.7

Telaio porta coperchio per vetrina inclinata h 98  
Frame supporting glass top for sloped showcase h 98

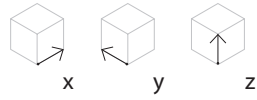
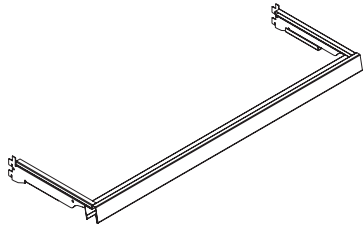

x	y	z	codice code	note notes
100	30	--	34.570	

finitura finish	colori colours
V	2004
	6018
	6027
	• 7035
	AMA
	• ANT
	AZZ
	1001
	• BIA
	BLU
	GIA
	MAR
	• MTZ
	• PAN
	RO3
	BIMCL
	NRMCL
	• OXI

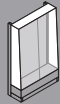

Vetrine  
Glass Cabinets

9.8

Top in vetro temprato per vetrina inclinata h 98  
Tempered glass top for sloped showcase h 98

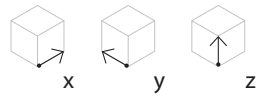
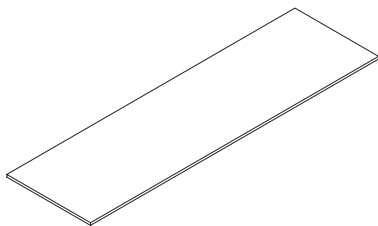

x	y	z	codice code	finitura e colore finish & colour	note notes
100	30	--	17.862	NT	

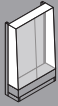

Vetrine  
Glass Cabinets

9.9

Guida inferiore per vetrina inclinata h 98  
Lower slide way for sloped showcase h 98

	x	y	z	codice code	note notes
singola <i>single</i>	100	6	6	22.379	
dx rh	100	6	6	22.381	
intermedio <i>intermediate</i>	100	6	6	22.280	
sx lh	100	6	6	22.382	

finitura finish	colori colours
V	2004
	6018
	6027
•	7035
	AMA
•	ANT
	AZZ
	1001
•	BIA
	BLU
	GIA
	MAR
•	MTZ
•	PAN
	RO3
	BIMCL
	NRMCL
•	OXI

Supporto per guida inferiore per vetrina inclinata h 98  
Support for lower slide way for sloped showcase h 98

	x	y	z	codice code	note notes
singola <i>single</i>	100	5	--	22.410	
dx rh	100	5	--	22.411	
intermedio <i>intermediate</i>	100	5	--	22.409	
sx lh	100	5	--	22.412	

finitura finish	colori colours
P	2004
	6018
	6027
•	7035
	AMA
	ANT
	AZZ
	1001
•	BIA
	BLU
	GIA
	MAR
	MTZ
•	PAN
	RO3
	BIMCL
	NRMCL
	OXI

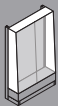

Vetrine  
Glass Cabinets

9.10

Anta in vetro per vetrina inclinata h 98  
Glass lockable sliding door for sloped showcase h 98

	x	y	z	codice code	finitura e colore finish & colour	note notes
	53,8	--	95,5	22.413	NT	

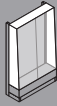

Vetrine  
Glass Cabinets

9.11

Spalla laterale per vetrina h 234  
Side panel for showcase h 234

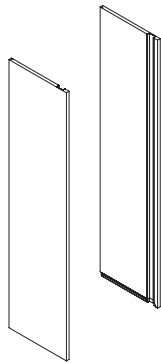

	x	y	z	codice code	note notes
dx rh	--	40	219,5	22.349	
sx lh	--	40	219,5	22.350	
dx rh	--	50	219,5	22.351	
sx lh	--	50	219,5	22.352	
dx rh	--	60	219,5	22.353	
sx lh	--	60	219,5	22.354	

finitura finish	colori colours
T	
•	7035
•	ACE
•	BIA
•	FAG
•	MTZ
•	PAN
•	A439
•	ANT
	K101
	3813
	2293
	990XA
	990XM
	A838
	999XA
	995XM
	989XR
	994XS
	997XS
	983XR
	984XA
	BLACK
	GREEN
	BEIGE
	WHITE

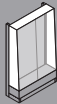

Vetrine  
Glass Cabinets

9.12

Spalla laterale aperta con inserto vetro per vetrina h 234  
Open side panel with glass shoulder for showcase h 234

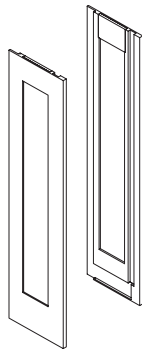

	x	y	z	codice code	note notes
dx rh	--	40	219,5	22.603	
sx lh	--	40	219,5	22.604	
dx rh	--	50	219,5	22.605	
sx lh	--	50	219,5	22.606	
dx rh	--	60	219,5	22.607	
sx lh	--	60	219,5	22.608	

finitura finish	colori colours
T	
•	7035
•	ACE
•	BIA
•	FAG
•	MTZ
•	PAN
•	A439
•	ANT
	K101
	3813
	2293
	990XA
	990XM
	A838
	999XA
	995XM
	989XR
	994XS
	997XS
	983XR
	984XA
	BLACK
	GREEN
	BEIGE
	WHITE

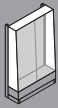

Vetrine  
Glass Cabinets

9.13

Guida inferiore per vetrina h 234  
Lower slide way for showcase h 234

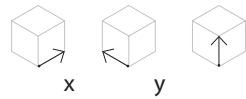
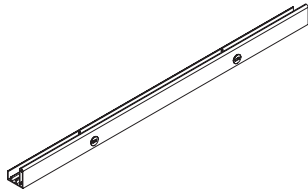

x	y	z	codice code
100	6	6	22.280

note notes	finitura finish	colori colours	colori colours
	V		
		2004	MAR
		6018	• MTZ
		6027	• PAN
	•	7035	RO3
		AMA	BIMCL
	•	ANT	NRMCL
		AZZ	• OXI
		1001	GIA
	•	BIA	
		BLU	

Terminale per guida inferiore per vetrina h 234  
End piece for lower slide way for showcase h 234

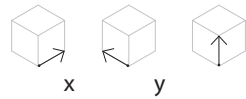
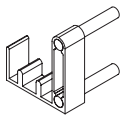

x	y	z	codice code
1,8	6	6	22.281

note notes	finitura finish	colori colours	colori colours
	V		
		2004	MAR
		6018	• MTZ
		6027	• PAN
	•	7035	RO3
		AMA	BIMCL
	•	ANT	NRMCL
		AZZ	• OXI
		1001	GIA
	•	BIA	
		BLU	

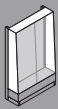

Vetrine  
Glass Cabinets

9.14

Guida superiore per vetrina h 234  
Upper slide way for showcase h 234

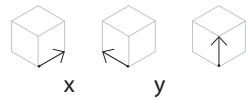
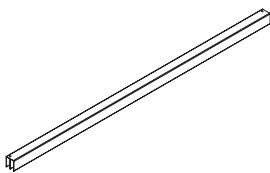

x	y	z	codice code
100	3	3,5	22.283

note notes	finitura finish	colori colours	colori colours
	V		
		2004	MAR
		6018	• MTZ
		6027	• PAN
	•	7035	RO3
		AMA	BIMCL
	•	ANT	NRMCL
		AZZ	• OXI
		1001	GIA
	•	BIA	
		BLU	

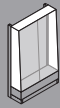

Vetrine  
Glass Cabinets

9.15

Antina in vetro temprato per vetrina h 234  
*Tempered glass lockable sliding door for showcase h 234*

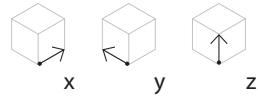
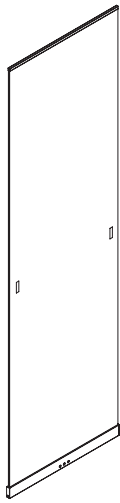

53,8    --    200

codice  
code

22.347

finitura e  
colore  
finish &  
colour

NT

note  
notes

vedi schema  
a pag. 271  
*see setting scheme,  
pag. 271*

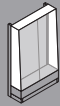

Vetrine  
Glass Cabinets

9.16

Fermo inferiore per ante vetrine  
*Lower retainer for showcase glass door*

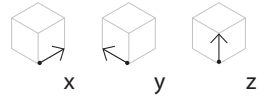

2    1,8    1,8

codice  
code

22.285

finitura e  
colore  
finish &  
colour

C

note  
notes

Accessori per Vetrine  
Glass Cabinets Accessories

9.17

Serratura con chiave per ante vetrine  
*Lock with key for showcase door*

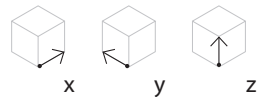
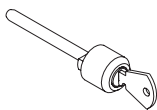

--    5,5    --

codice  
code

34.520

finitura e  
colore  
finish &  
colour

C

note  
notes

Accessori per Vetrine  
Glass Cabinets Accessories

9.18

Serratura supplementare con chiave per ante vetrine  
*Additional lock with key for showcase door*

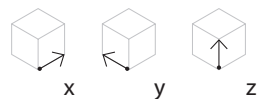
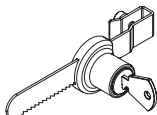

--    --    --

codice  
code

34.408

finitura e  
colore  
finish &  
colour

C

note  
notes

Mobili base per elementi con base h 10  
Base cabinets for 17 cm high bases

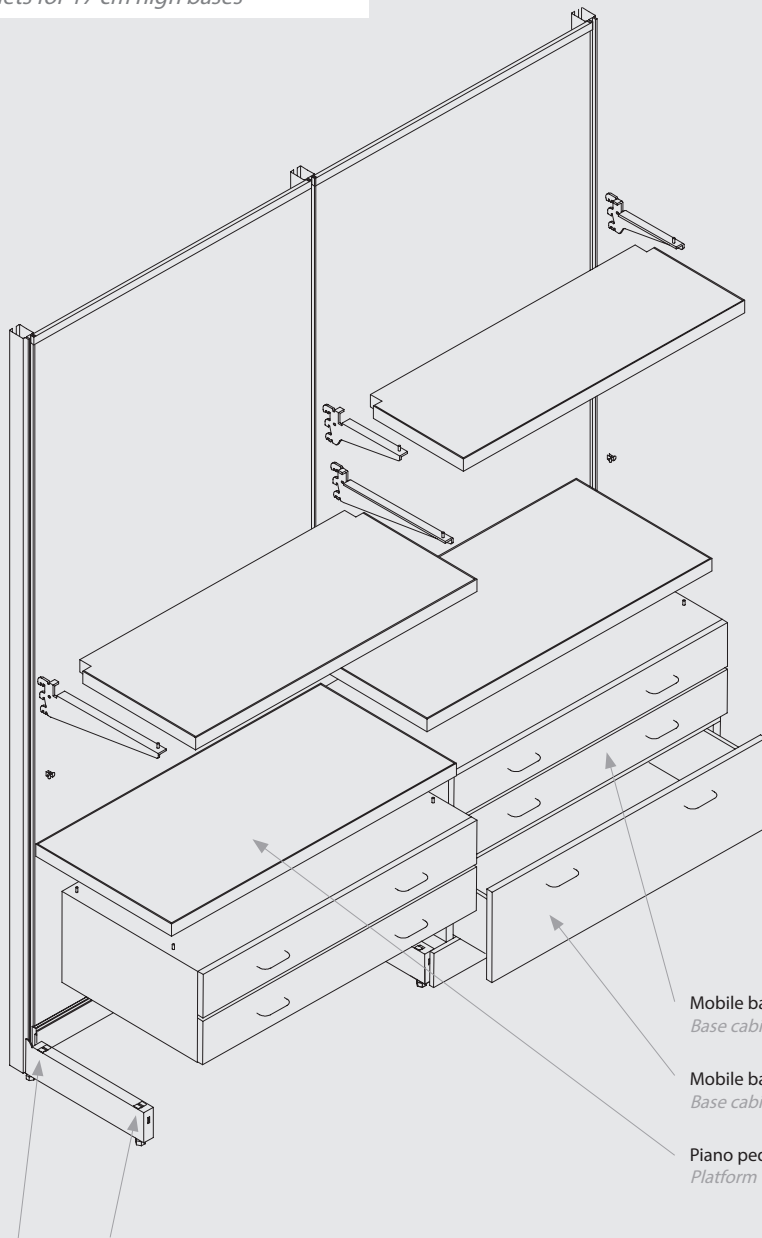

Supporti per piano pedana: 2.9  
Supports for platform top: 2.9

Mobile base a due cassetti: 9.20  
Base cabinet with 2 drawers: 9.20

Mobile base a un cassetto: 9.19  
Base cabinet with 1 drawer: 9.19

Piano pedana: 2.9  
Platform top: 2.9



Piano pedana: 2.9  
Platform top: 2.9

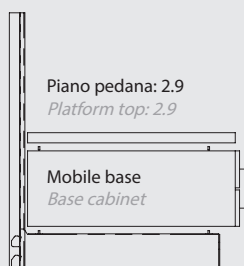

Piano pedana: 2.9  
Platform top: 2.9

Mobile base  
Base cabinet

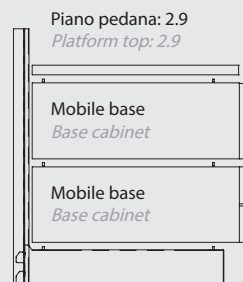

Piano pedana: 2.9  
Platform top: 2.9

Mobile base  
Base cabinet

Mobile base  
Base cabinet

**Mobili base per elementi con base h 17**  
*Base cabinets for 17 cm high bases*

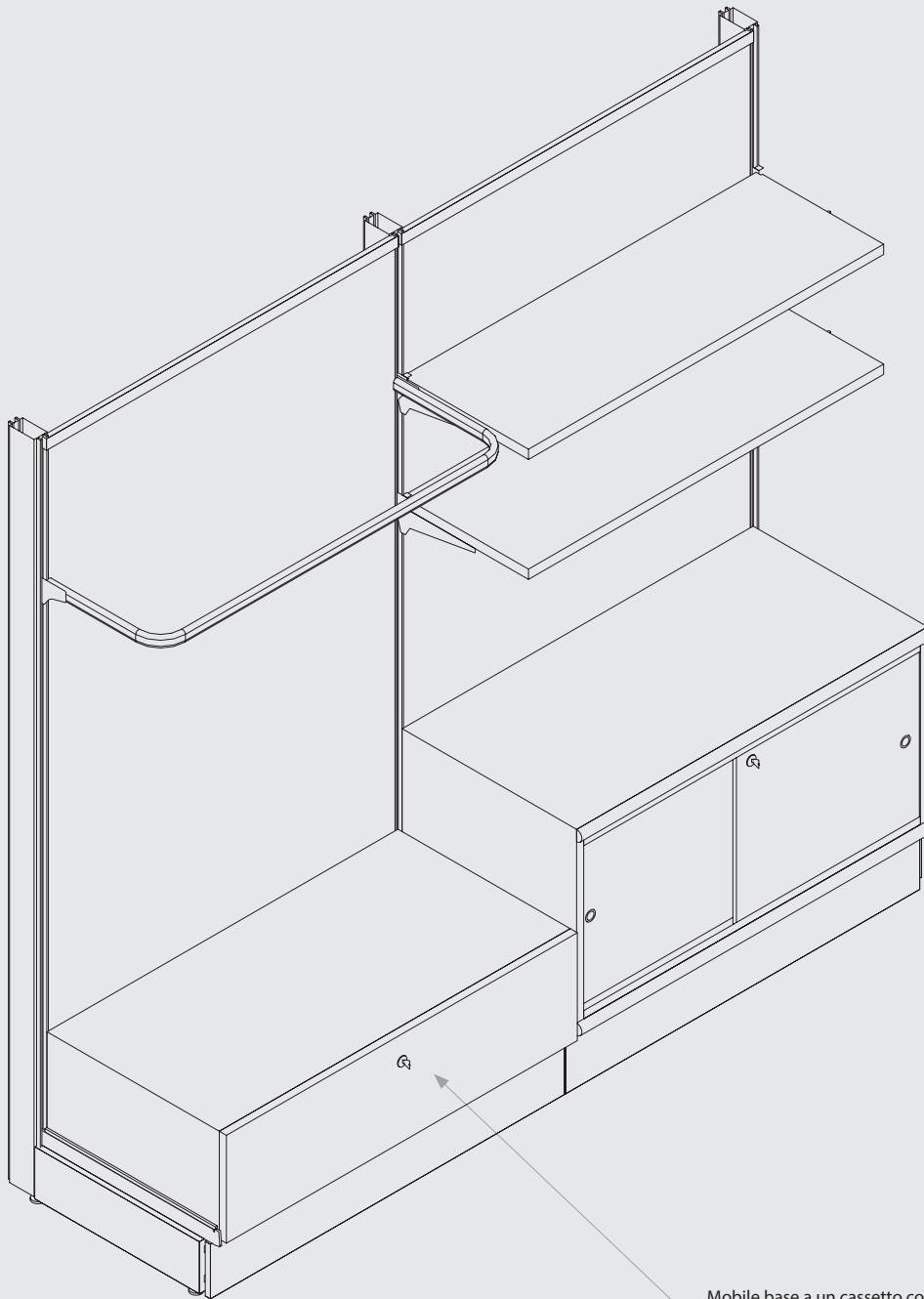

**Mobile base a un cassetto con serratura: 9.21**  
*Base cabinet with 1 drawer and lock: 9.21*



Mobili Base  
Base Platforms

9.19

Mobile base a un cassetto per basi h 10 con piano pedana  
*Base cabinet with 1 drawer for platform tops (base h 10)*

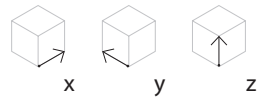
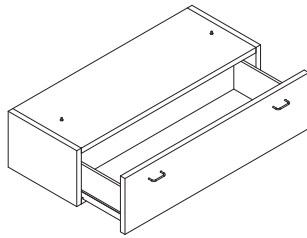

x	y	z	codice code
100	40	26	21.261
100	50	26	21.262
100	60	26	21.263

Piano pedana e fermi: 2.9  
*Platform tops and supports: 2.9*

note notes	finitura finish	colori colours	colori colours
T			
•	7035	A838	
•	ACE	999XA	
•	BIA	995XM	
•	FAG	989XR	
•	MTZ	994XS	
•	PAN	997XS	
•	A439	983XR	
•	ANT	984XA	
	K101	BLACK	
	3813	GREEN	
	2293	BEIGE	
	990XA	WHITE	
	990XM		



Mobili Base  
Base Platforms

9.20

Mobile base a due cassetti per basi h 10 con piano pedana  
*Base cabinet with 2 drawers for platform tops (base h 10)*

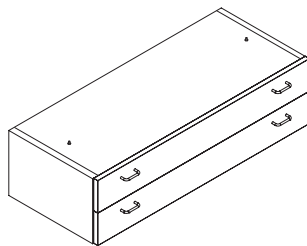

x	y	z	codice code
100	40	26	21.264
100	50	26	21.265
100	60	26	21.266

Piano pedana e fermi: 2.9  
*Platform tops and supports: 2.9*

note notes	finitura finish	colori colours	colori colours
T			
•	7035	A838	
•	ACE	999XA	
•	BIA	995XM	
•	FAG	989XR	
•	MTZ	994XS	
•	PAN	997XS	
•	A439	983XR	
•	ANT	984XA	
	K101	BLACK	
	3813	GREEN	
	2293	BEIGE	
	990XA	WHITE	
	990XM		



Mobili Base  
Base Platforms

9.21

Mobile base a un cassetto con serratura e supporti avvitati per basi h 17  
*Base cabinet with 1 drawer and lock for bases h 17*

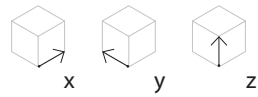
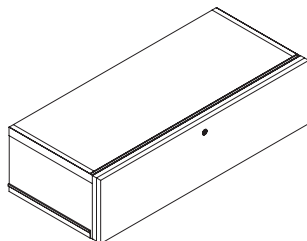

x	y	z	codice code
50	40	26	21.287
50	50	26	21.277
50	60	26	21.288

Piano pedana e fermi: 2.9  
*Platform tops and supports: 2.9*

note notes	finitura finish	colori colours	colori colours
T			
•	7035	A838	
•	ACE	999XA	
•	BIA	995XM	
•	FAG	989XR	
•	MTZ	994XS	
•	PAN	997XS	
•	A439	983XR	
•	ANT	984XA	
	K101	BLACK	
	3813	GREEN	
	2293	BEIGE	
	990XA	WHITE	
	990XM		

100	40	26	21.239
100	50	26	21.182
100	60	26	21.230





Mobili Base  
Base Platforms

9.22

Mobile base con ante a battente in legno e supporti avvitati per base h 17  
Base cabinet with wooden doors for base h 17

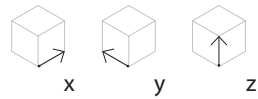
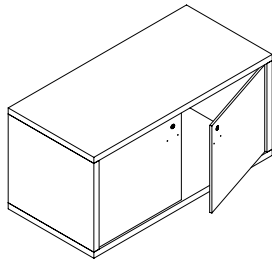

x	y	z	codice code
75	50	50	21.375
100	50	50	21.377
75	60	50	21.376
100	60	50	21.378

note notes	finitura finish	colori colours	colori colours
T			
•	7035	A838	
•	ACE	999XA	
•	BIA	995XM	
•	FAG	989XR	
•	MTZ	994XS	
•	PAN	997XS	
•	A439	983XR	
•	ANT	984XA	
	K101	BLACK	
	3813	GREEN	
	2293	BEIGE	
	990XA	WHITE	
	990XM		



Mobili Base  
Base Platforms

9.23

Mobile base con ante scorrevoli in legno e supporti avvitati per base h 17  
Base cabinet with wooden sliding doors for base h 17

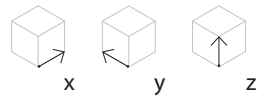
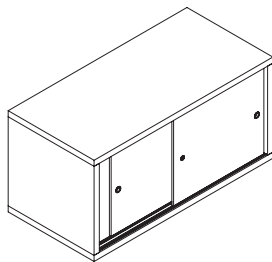

x	y	z	codice code
75	50	50	21.178
100	50	50	21.174
75	60	50	21.179
100	60	50	21.175

note notes	finitura finish	colori colours	colori colours
T			
•	7035	A838	
•	ACE	999XA	
•	BIA	995XM	
•	FAG	989XR	
•	MTZ	994XS	
•	PAN	997XS	
•	A439	983XR	
•	ANT	984XA	
	K101	BLACK	
	3813	GREEN	
	2293	BEIGE	
	990XA	WHITE	
	990XM		



Mobili Base  
Base Platforms

9.24

Mobile base con ante scorrevoli in vetro temperato e supporti avvitati per base h 17  
Base cabinet with tempered glass sliding doors for base h 17

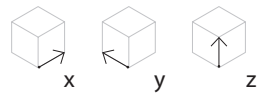
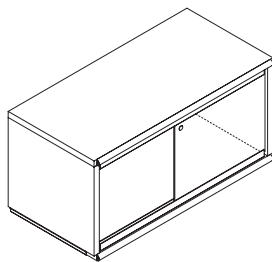

x	y	z	codice code
75	50	50	21.352
100	50	50	21.333
75	60	50	21.353
100	60	50	21.351

note notes	finitura finish	colori colours	colori colours
T			
•	7035	A838	
•	ACE	999XA	
•	BIA	995XM	
•	FAG	989XR	
•	MTZ	994XS	
•	PAN	997XS	
•	A439	983XR	
•	ANT	984XA	
	K101	BLACK	
	3813	GREEN	
	2293	BEIGE	
	990XA	WHITE	
	990XM		

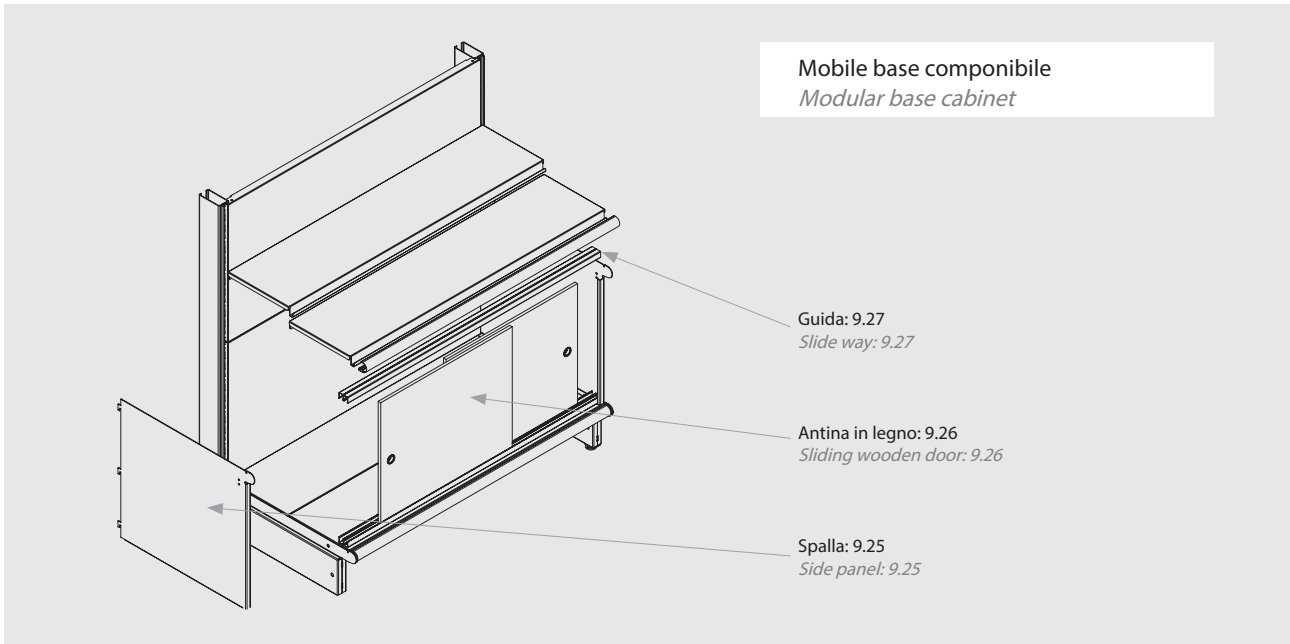

Mobili Base  
Base Platforms

**9.25** Spalla per mobile base componibile per basi h 17  
*Side panel for modular base cabinet for base h 17*

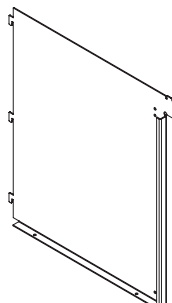
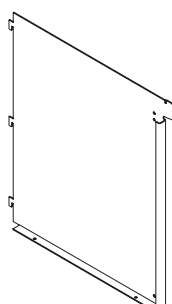
					codice code	note notes	finitura finish	colori colours
 testa inclinata <i>sloped head</i>	dx rh	--	40	47	21.246		V 2004 6018 6027 • 7035 AMA • ANT AZZ 1001 • BIA BLU GIA MAR • MTZ • PAN RO3 BIMCL NRMCL • OXI	
	sx lh	--	40	47	21.247			
	dx rh	--	50	47	21.248			
	sx lh	--	50	47	21.249			
	dx rh	--	60	47	21.250			
	sx lh	--	60	47	21.251			
 testa tonda <i>round head</i>	dx rh	--	40	47	21.240			
	sx lh	--	40	47	21.241			
	dx rh	--	50	47	21.242			
	sx lh	--	50	47	21.243			
	dx rh	--	60	47	21.244			
	sx lh	--	60	47	21.245			





Mobili Base  
Base Platforms

9.26

Antina in legno per mobile base componibile  
*Sliding wooden door for modular base cabinet*

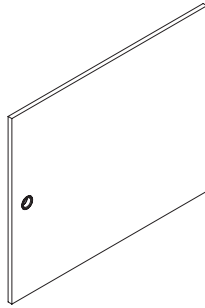

	x	y	z	codice code	note notes
passo 75 bay 75	39	1	42,3	21.195	
passo 100 bay 100	51,5	1	42,3	21.194	

finitura finish	colori colours
<b>T</b>	
•	7035
•	ACE
•	BIA
•	FAG
•	MTZ
•	PAN
•	A439
•	ANT
	K101
	3813
	2293
	990XA
	990XM
	A838
	999XA
	995XM
	989XR
	994XS
	997XS
	983XR
	984XA
	BLACK
	GREEN
	BEIGE
	WHITE



Mobili Base  
Base Platforms

9.27

Guida superiore/inferiore per mobile base componibile  
*Upper/lower slide way for modular base cabinet*

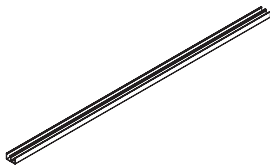

	x	y	z	codice code	note notes
passo 75 bay 75	75	--	--	21.259	
passo 100 bay 100	100	--	--	21.258	

finitura finish	colori colours
<b>V</b>	
	2004
	6018
	6027
•	7035
	AMA
•	ANT
	AZZ
	1001
•	BIA
	BLU
	GIA
	MAR
•	MTZ
•	PAN
	RO3
	BIMCL
	NRMCL
•	OXI

**note**  
*notes*

**note**  
*notes*

# Stander *Display stands*

# 10

Espositori carrellati, basi, fondali, piani e accessori per piantane e strutture stander.

*Wheeled display, bases, panels, shelves and accessories for display stand uprights and display stand structures.*

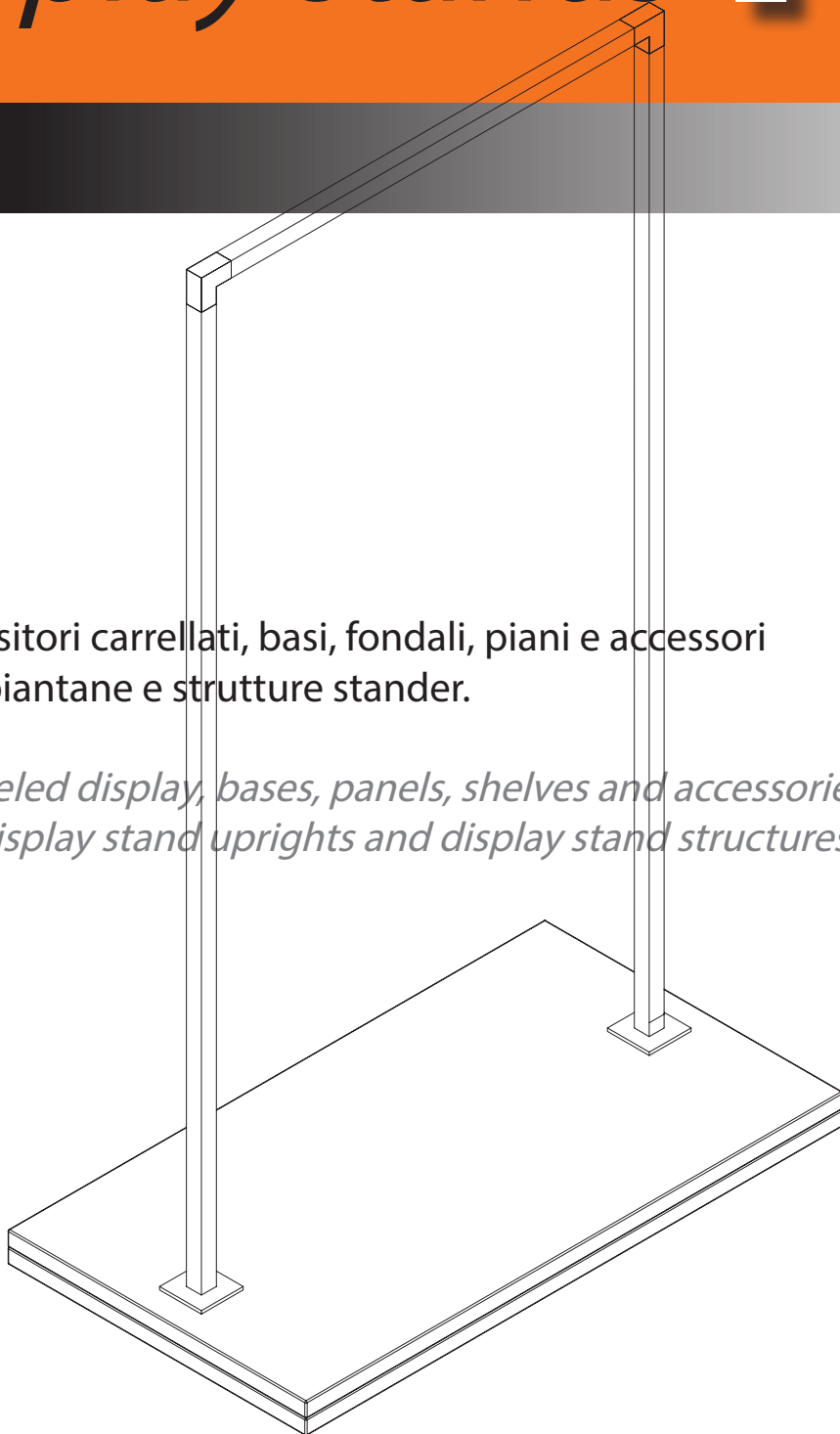



Isole stander  
Display stands

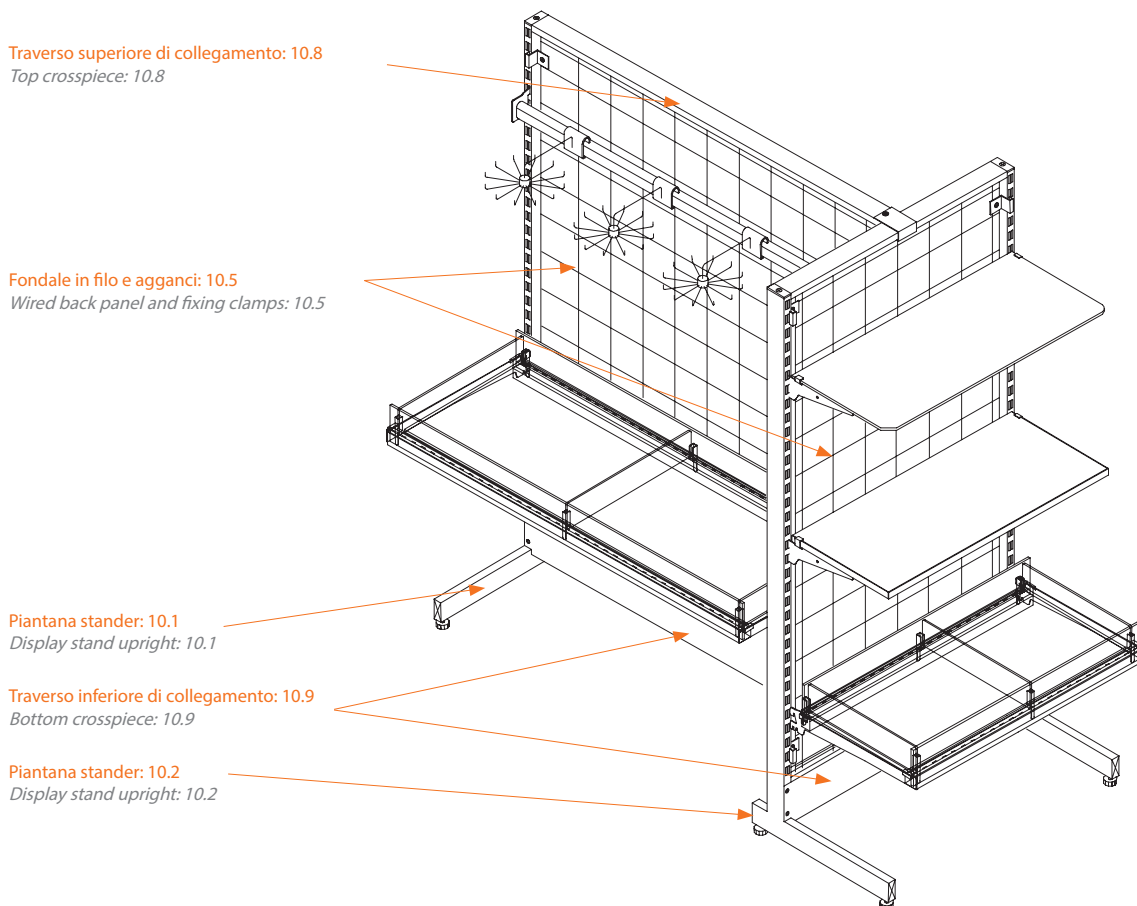
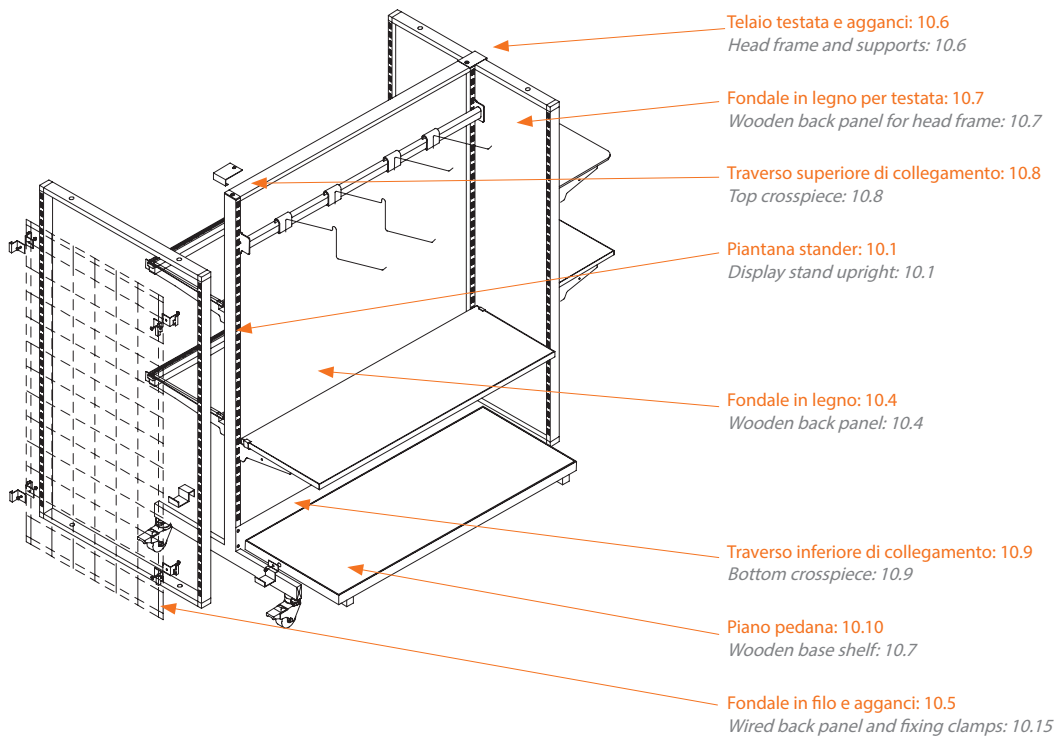



**Espositore stander h 151 con base e fondale legno**  
*Display stands h 151 cm with wooden base and backpanel*

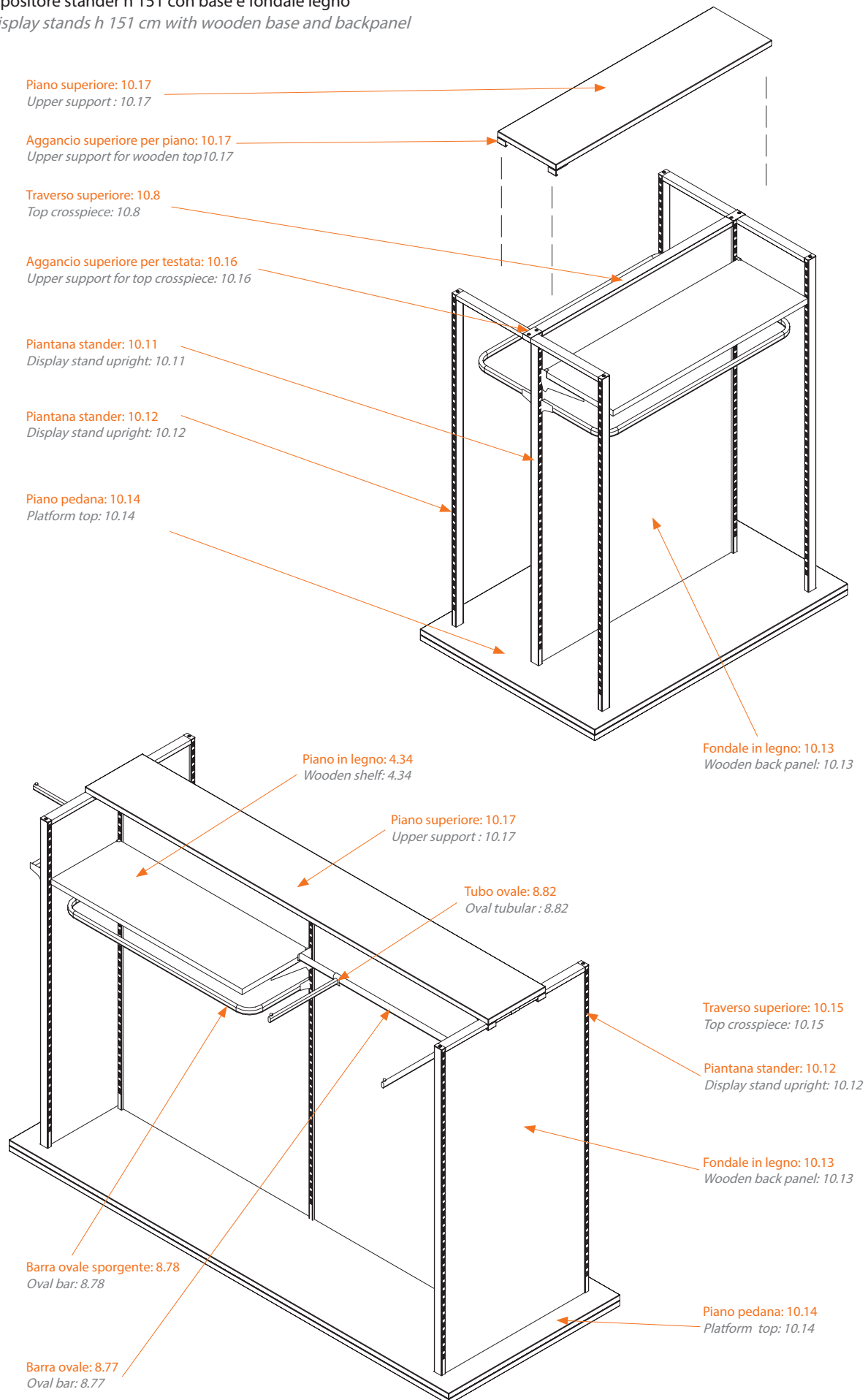



Isole stander  
Display stands

10.1

Piantane stander con doppia base  
Display stand uprights with 2 bases

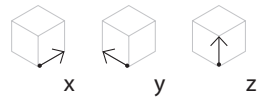
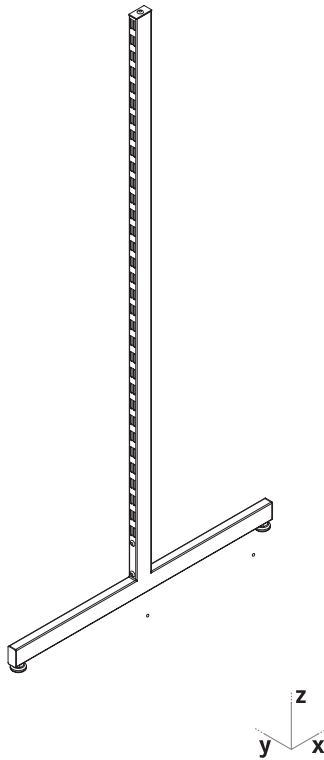

x	y	z	codice code	note notes
67	--	133	10.-65	

Le piantane stander sono complete di tappi, viti e regolatori  
*Display stand uprights are sold with caps, screws and adjusters*

finitura finish		colori colours
C	V	
		2004
		6018
		6027
	•	7035
		AMA
	•	ANT
		AZZ
		1001
	•	BIA
		BLU
		GIA
		MAR
	•	MTZ
	•	PAN
		RO3
		BIMCL
		NRMCL
	•	OXI
		---



Isole stander  
Display stands

10.2

Piantane stander con base semplice per h 139  
Display stand uprights for h 139 with 1 base

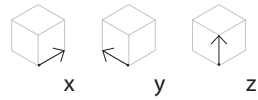
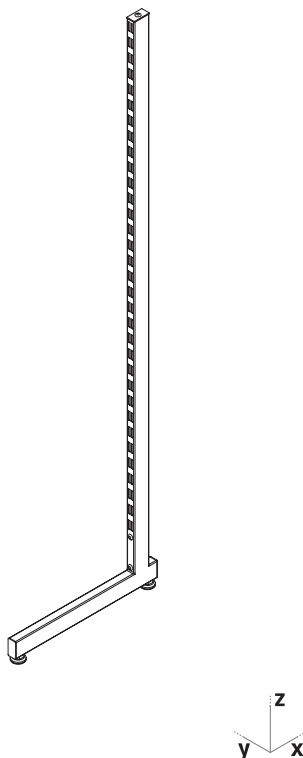

x	y	z	codice code	note notes
37,5	--	133	10.-64	

Le piantane stander sono complete di tappi, viti e regolatori  
*Display stand uprights are sold with caps, screws and adjusters*

finitura finish		colori colours
C	V	
		2004
		6018
		6027
	•	7035
		AMA
	•	ANT
		AZZ
		1001
	•	BIA
		BLU
		GIA
		MAR
	•	MTZ
	•	PAN
		RO3
		BIMCL
		NRMCL
	•	OXI
		---

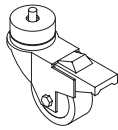

Ruota  $\varnothing=6$  z=2,5 cm tipo: frenato  
con bussola e vite di fissaggio  
*Brake wheel  $\varnothing=6$  z=2,5 cm with bushing  
and screw*

codice  
code  
finitura e  
colore  
finish &  
colour

12.-35

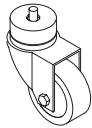

Ruota  $\varnothing=6$  z=2,5 cm tipo: folle  
con bussola e vite di fissaggio  
*Idle wheel  $\varnothing=6$  z=2,5 cm with bushing  
and screw*

12.-36

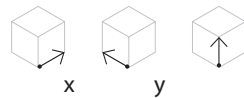
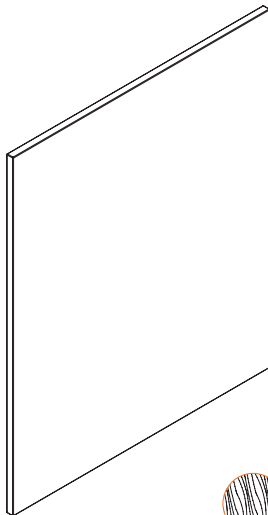

x	y	z	codice code	note notes
73	2	118,2	13.271	
98	2	118,2	13.270	

finitura finish	colori colours
T	
•	7035
•	ACE
•	BIA
•	FAG
•	MTZ
•	PAN
•	A439
•	ANT
	K101
	3813
	2293
	990XA
	990XM
	A838
	999XA
	995XM
	989XR
	994XS
	997XS
	983XR
	984XA
	BLACK
	GREEN
	BEIGE
	WHITE



10.5

Fondale in filo stander (maglia 10x10)  
Wired back panel for display stand frames

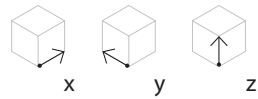
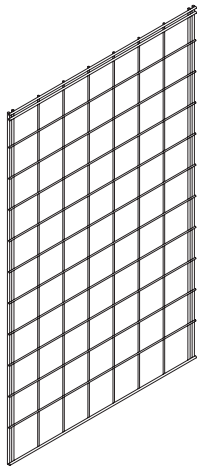

	x	y	z	codice code	note notes
	70	--	114	13.-90	
	95	--	114	13.-89	

finitura finish	colori colours
C	V
	2004
	6018
	6027
	7035
	AMA
	ANT
	AZZ
	1001
	BIA
	BLU
	GIA
	MAR
	MTZ
	PAN
	RO3
	BIMCL
	NRMCL
	OXI
	---

Aggancio per fondale stander  
Fixing clamp for wired back panel

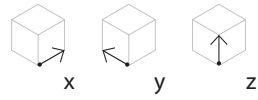
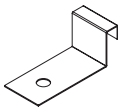

	x	y	z	codice code	note notes
	--	--	--	34.-80	

finitura finish	colori colours
C	V
	2004
	6018
	6027
	7035
	AMA
	ANT
	AZZ
	1001
	BIA
	BLU
	GIA
	MAR
	MTZ
	PAN
	RO3
	BIMCL
	NRMCL
	OXI
	---



Vite  $\phi=4$  z=15 mm  
Screw  $\phi=4$  z=15 mm

34.-77



Dado flangiato  $\phi=4$  mm  
Steel nut  $\phi=4$  mm

34.-76



codice code  
finitura e colore finish & colour







Isole stander  
Display stands

10.10

Piano pedana stander in legno  
Wooden shelf display stand base

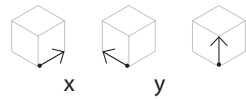
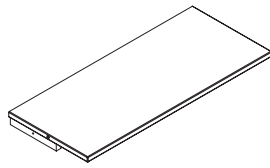

	x	y	z	codice code	note notes
	50	42,8	2,5	17.752	
	75	42,8	2,5	17.753	
	100	42,8	2,5	17.627	

finitura finish	colori colours
T	
•	7035
•	ACE
•	BIA
•	FAG
•	MTZ
•	PAN
•	A439
•	ANT
	K101
	3813
	2293
	990XA
	990XM
	A838
	999XA
	995XM
	989XR
	994XS
	997XS
	983XR
	984XA
	BLACK
	GREEN
	BEIGE
	WHITE



Isole stander  
Display stands

10.11

Piantana stander con base doppia  
Display stand upright with 2 bases

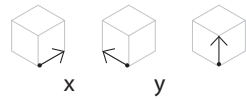
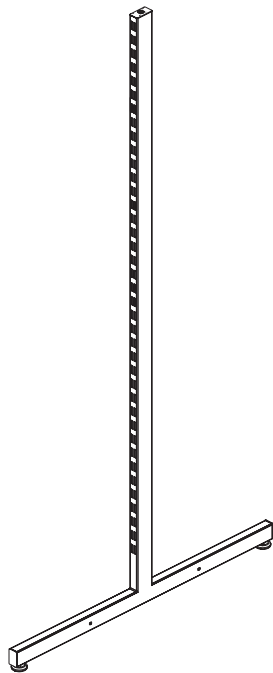

	x	y	z	codice code	note notes
	--	67	151	10.369	

**Le piantane stander sono complete di tappi, viti e ruote pivotanti**

*Display stand uprights are sold with caps, screws and pivot wheels*

finitura finish	colori colours
C	V
	2004
	6018
	6027
	7035
	AMA
	ANT
	AZZ
	1001
	BIA
	BLU
	GIA
	MAR
	MTZ
	PAN
	RO3
	BIMCL
	NRMCL
	OXI
•	---



Isole stander  
Display stands

10.12

Piantana stander con attacco filettato  
Display stand upright with threaded joint cap

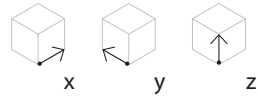

x	y	z	codice code	note notes
--	--	142,9	10.392	

**Le piantane stander sono complete di tappi, viti e regolatori**

Display stand uprights are sold with caps, screws and adjusters

finitura finish	colori colours
C	V
	2004
	6018
	6027
	7035
	AMA
	ANT
	AZZ
	1001
	BIA
	BLU
	GIA
	MAR
	MTZ
	PAN
	RO3
	BIMCL
	NRMCL
	OXI
	---



Isole stander  
Display stands

10.13

Fondale in legno per espositore stander  
Wooden back panel for display stand

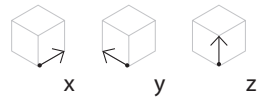
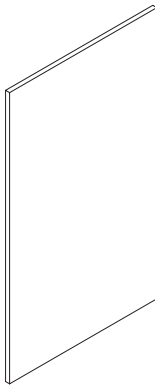

x	y	z	codice code	note notes
73	2	143	13.495	
98	2	143	13.573	

finitura finish	colori colours
T	
	7035
•	ACE
•	BIA
	FAG
•	MTZ
•	PAN
•	A439
•	ANT
	K101
	3813
	2293
	990XA
	990XM
	A838
	999XA
	995XM
	989XR
	994XS
	997XS
	983XR
	984XA
	BLACK
	GREEN
	BEIGE
	WHITE





Isole stander  
Display stands

10.14

Piano pedana per espositore stander  
Platform top for display stand

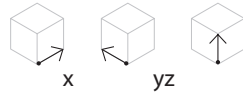
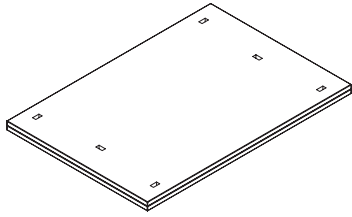

codice  
code

note  
notes

	x	yz	z	codice code	note notes
122	90	5	40.-22		
222	90	5	40.-23		
322	90	5	40.-61		



finitura finish	colori colours
T	
•	7035
•	ACE
•	BIA
•	FAG
•	MTZ
•	PAN
•	A439
•	ANT
	K101
	3813
	2293
	990XA
	990XM
	A838
	999XA
	995XM
	989XR
	994XS
	997XS
	983XR
	984XA
	BLACK
	GREEN
	BEIGE
	WHITE



Isole stander  
Display stands

10.15

Traverso per collegamento piantana stander con foro  
Crosspiece for stander upright connection with hole

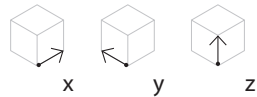
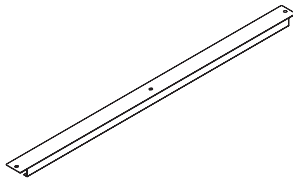

codice  
code

note  
notes

	x	y	z	codice code	note notes
75	4	--	34.-87	FC	
100	4	--	34.-86	FC	



finitura finish	colori colours
C	V
	2004
	6018
	6027
	7035
	AMA
	ANT
	AZZ
	1001
	BIA
	BLU
	GIA
	MAR
	MTZ
	PAN
	RO3
	BIMCL
	NRMCL
	OXI
•	---



Isole stander  
Display stands

10.16

Aggancio superiore per telaio testata stander  
Upper support clamp for display stand head frame

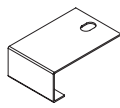

per piano superiore  
for upper support

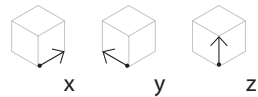

	x	y	z	codice code	note notes
per piano superiore for upper support	6	4	--	34.-82	

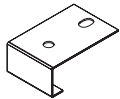

per testata  
for stand head

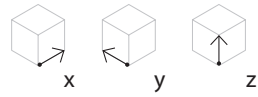

	x	y	z	codice code	note notes
per testata for stand head	6	4	--	34.-82	FC



finitura finish		colori colours	
C	V		
			2004
			6018
			6027
			7035
			AMA
			ANT
			AZZ
			1001
			BIA
			BLU
			GIA
			MAR
			MTZ
			PAN
			RO3
			BIMCL
			NRMCL
			OXI
			---



Isole stander  
Display stands

10.17

Piano superiore in legno avvitato  
Upper support for stander frame

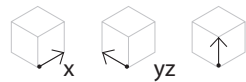
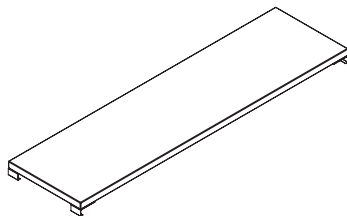

	x	yz	z	codice code	note notes
	111	30	2,5	40.-24	
	211	30	2,5	40.-25	
	322	30	2,5	40.-63	



finitura finish		colori colours	
T			
			7035
			ACE
			BIA
			FAG
			MTZ
			PAN
			A439
			ANT
			K101
			3813
			2293
			990XA
			990XM
			A838
			999XA
			995XM
			989XR
			994XS
			997XS
			983XR
			984XA
			BLACK
			GREEN
			BEIGE
			WHITE

Fissaggio  
Fixing

Vite autofilettante da 4,5 x 2  
Self-tapping screw 4.5 x 2

codice  
code

FE.239

#: 4

Aggancio per piano superiore  
Self-tapping screw 4.5 x 2

34.-82

#: 4

**note**

*notes*

# Montanti *Uprights*

# 11

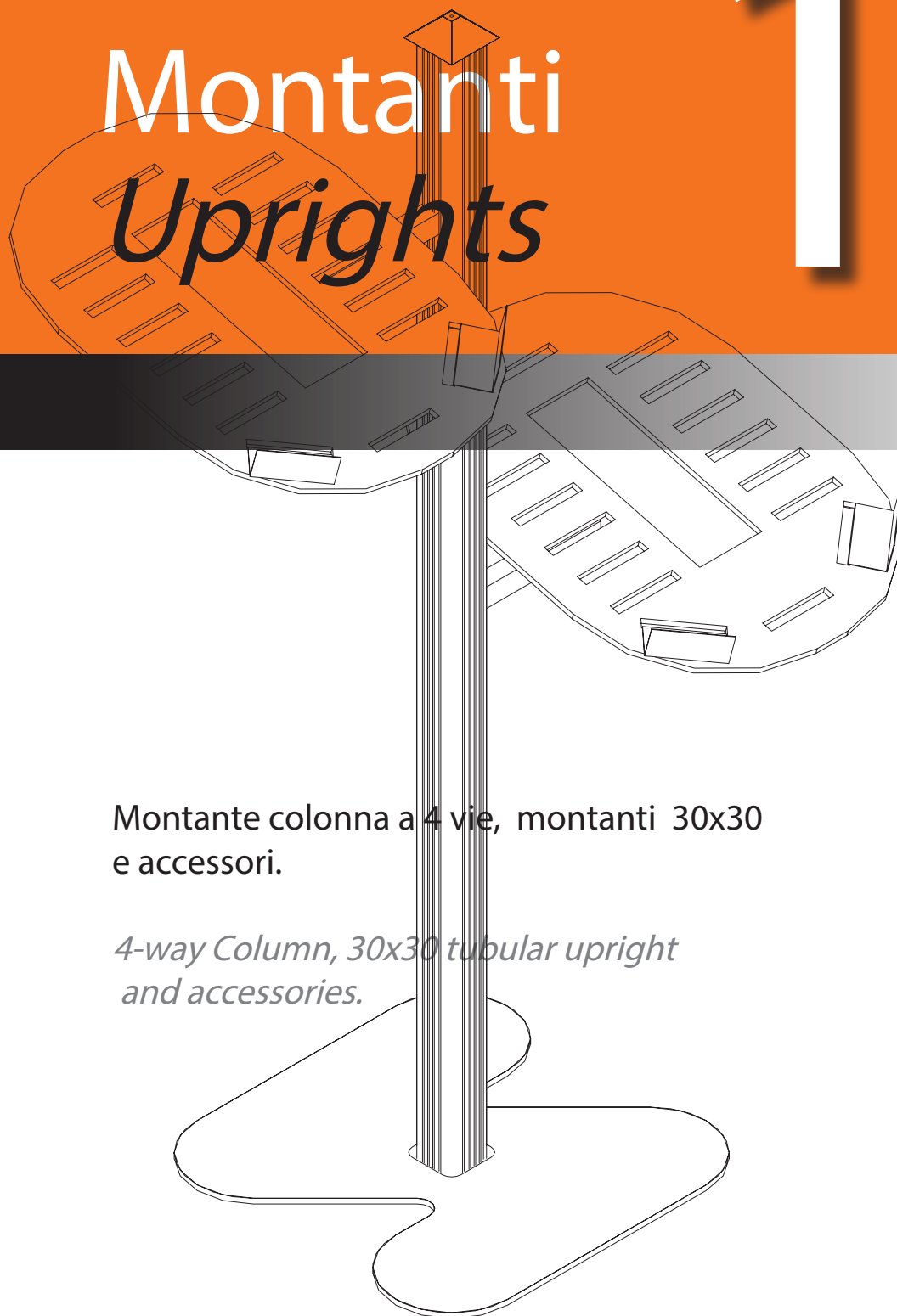

Montante colonna a 4 vie, montanti 30x30 e accessori.

*4-way Column, 30x30 tubular upright and accessories.*



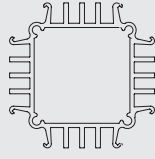

Montante a Colonna a 4-vie  
Facing setting

## Espositori con colonna a 4 vie 4-way column stands

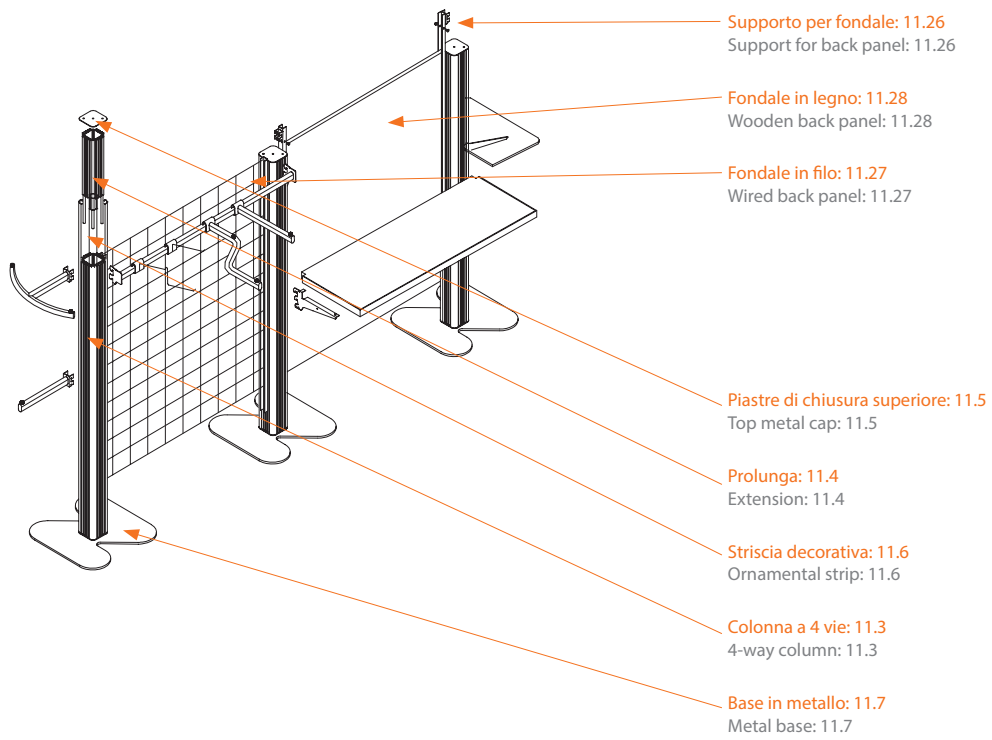

Piano espositivo in vetro e traverso: 4.25  
Glass display shelf: 4.25

Mensola: 5.12  
Flying bracket: 5.12

Telaio di testata: 11.23  
Head frame: 11.23

Fondale: 11.24 / 11.25  
Back panel: 11.24 / 11.25

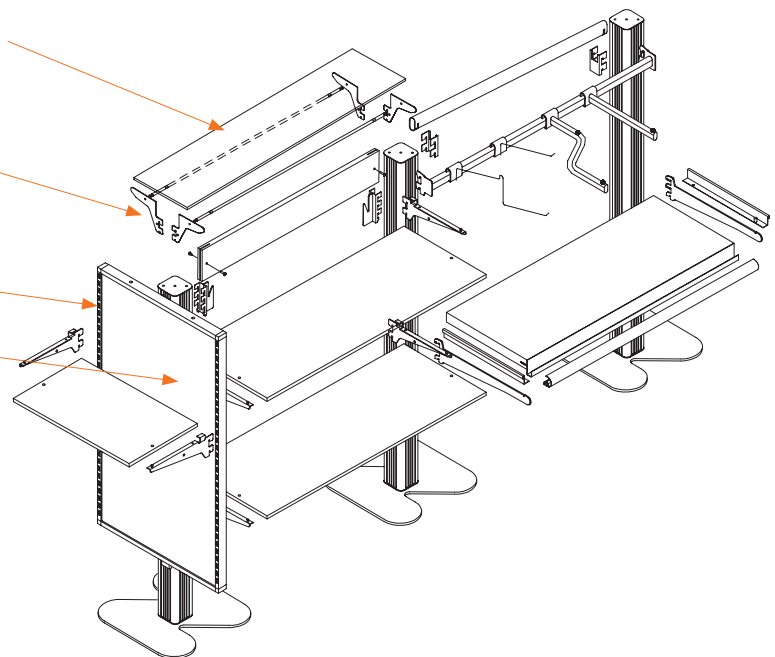

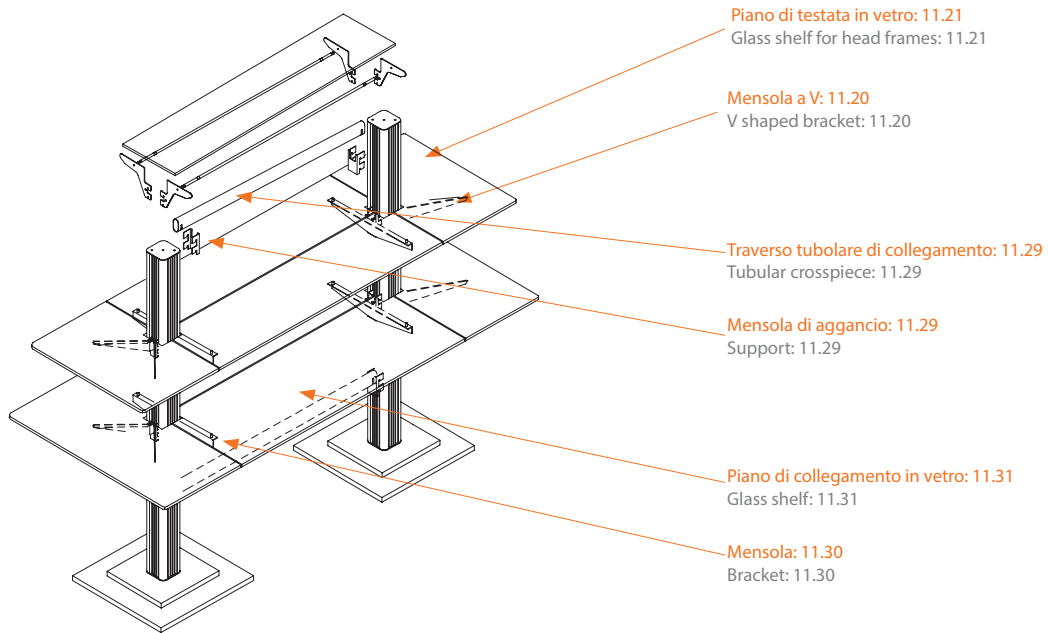

**Colonna a 4 vie**  
4-way column

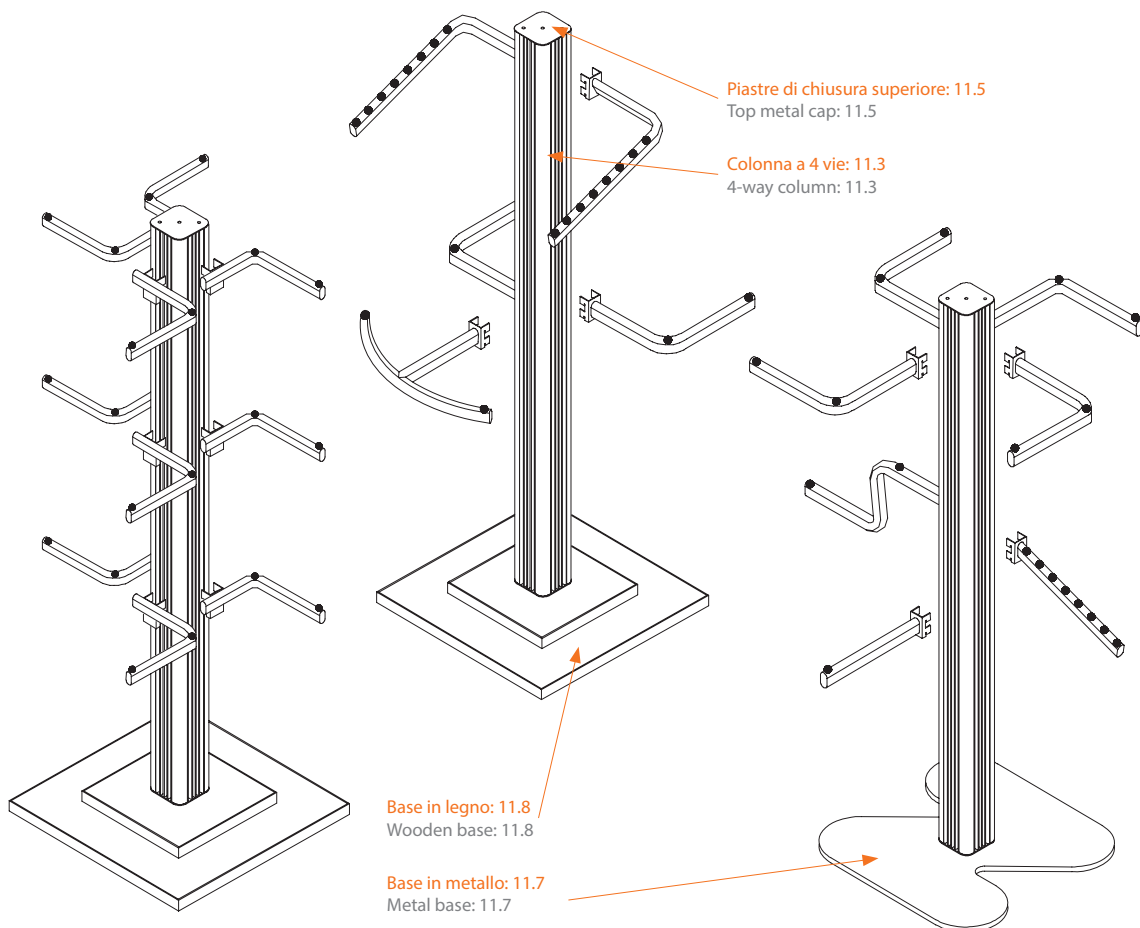



**11.1** Colonna a 4 vie 4-way column  
**Espositore carrelato singolo con colonna a 4 vie**  
**Wheeled display stand with 4-way column**

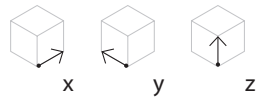
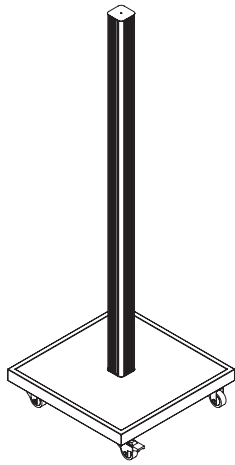

x	y	z	codice code	note notes
62	62	162	34.448	

esempio codice:  
T SBI / 7035  
example code:  
T SBI / 7035

finitura finish	colori colours
T	
•	7035
•	ACE
•	BIA
	FAG
•	MTZ
•	PAN
•	A439
•	ANT
	K101
	3813
	2293
	990XA
	990XM
	A838
	999XA
	995XM
	989XR
	994XS
	997XS
	983XR
	984XA
	BLACK
	GREEN
	BEIGE
	WHITE

**11.2** Colonna a 4 vie 4-way column  
**Espositore carrelato doppio con colonna a 4 vie**  
**Wheeled display stand with 4-way column**

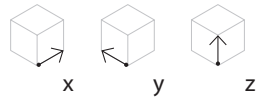
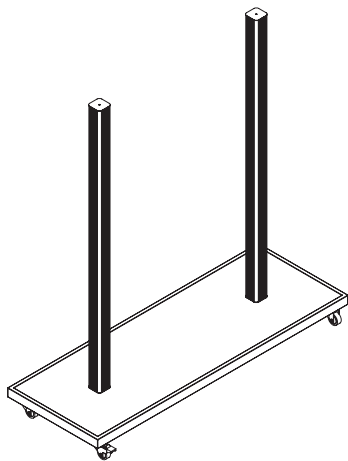

x	y	z	codice code	note notes
160	62	162	34.449	

esempio codice:  
T SBI / 7035  
example code:  
T SBI / 7035

finitura finish	colori colours
T	
•	7035
•	ACE
•	BIA
	FAG
•	MTZ
•	PAN
•	A439
•	ANT
	K101
	3813
	2293
	990XA
	990XM
	A838
	999XA
	995XM
	989XR
	994XS
	997XS
	983XR
	984XA
	BLACK
	GREEN
	BEIGE
	WHITE



Colonna a 4 vie  
4-way column

11.3

Montante Colonna in alluminio a 4 vie  
Aluminium 4-way column

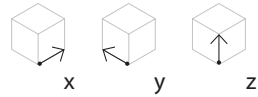

x y z

codice  
code

note  
notes

7,5	7,5	155	10.331
-----	-----	-----	--------

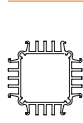
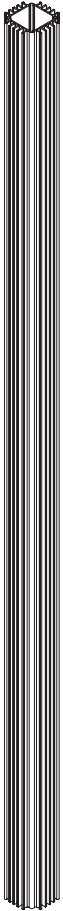

finitura  
finish

colori  
colours

V	
	2004
	6018
	6027
	• 7035
	AMA
	• ANT
	AZZ
	1001
	• BIA
	BLU
	GIA
	MAR
	• MTZ
	• PAN
	RO3
	BIMCL
	NRMCL
	• OXI



Colonna a 4 vie  
4-way column

11.4

Prolunga per colonna in alluminio a 4 vie  
Aluminium 4-way column extension

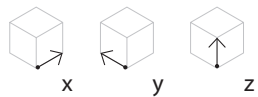

x y z

codice  
code

note  
notes

7,5	7,5	28,8	10.332
-----	-----	------	--------

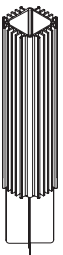

finitura  
finish

colori  
colours

V	
	2004
	6018
	6027
	• 7035
	AMA
	• ANT
	AZZ
	1001
	• BIA
	BLU
	GIA
	MAR
	• MTZ
	• PAN
	RO3
	BIMCL
	NRMCL
	• OXI

**Colonna a 4 vie**  
4-way column

**11.5** Piastre di chiusura e rinforzo  
Metal caps

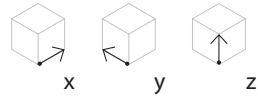

	x	y	z	codice code	note notes
superiore / top	7,8	7,8	--	10.333	
superiore conico / conic top	7,8	7,8	--	10.338	
inferiore / bottom	7,8	7,8	--	12.-45	



finitura finish	colori colours
V	2004
	6018
	6027
	• 7035
	• AMA
	• ANT
	AZZ
	1001
	• BIA
	BLU
	GIA
	MAR
	• MTZ
	• PAN
	RO3
	BIMCL
	NRMCL
	• OXI

**Colonna a 4 vie**  
4-way column

**11.6** Striscia decorativa  
Ornamental strip

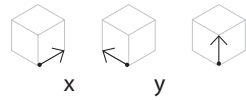

x	y	z	codice code	note notes
--	--	155	34.442	
--	--	184	34.443	



finitura finish	colori colours
T	
•	7035
•	ACE
•	BIA
	FAG
•	MTZ
•	PAN
•	A439
•	ANT
	K101
	3813
	2293
	990XA
	990XM
	A838
	999XA
	995XM
	989XR
	994XS
	997XS
	983XR
	BLACK
	GREEN
	BEIGE
	WHITE

**Colonna a 4 vie**  
4-way column

**11.7** Base in metallo  
Metal base

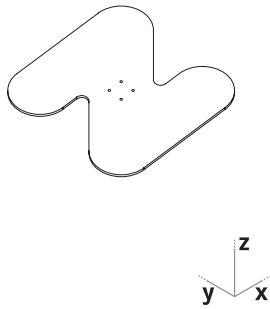

x	y	z	codice code	note notes	finitura finish	colori colours	colori colours
50	50	--	11.-73		V	2004	MAR
						6018	• MTZ
						6027	• PAN
						• 7035	RO3
						AMA	BIMCL
						• ANT	NRMCL
						AZZ	• OXI
						1001	GIA
						• BIA	
						BLU	

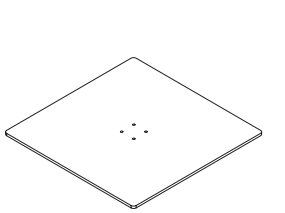

x	y	z	codice code	note notes
50	50	--	11.-77	

**Colonna a 4 vie**  
4-way column

**11.8** Base in legno  
Wooden base

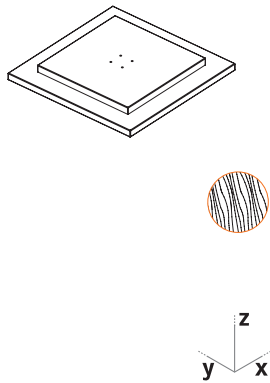

x	y	z	codice code	finitura finish	colori colours	colori colours	colori colours
50	50	5	11.-74	T	• 7035	3813	997XS
					• ACE	2293	983XR
					• BIA	990XA	BLACK
					FAG	990XM	GREEN
					• MTZ	A838	BEIGE
					• PAN	999XA	WHITE
					• A439	995XM	
					• ANT	989XR	
					K101	994XS	

**Colonna a 4 vie**  
4-way column

**11.9** Tubo ovale  
Oval tubular bar

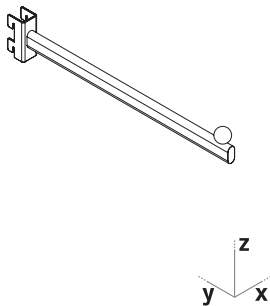

x	y	z	codice code	finitura finish	colori colours	colori colours
--	35	--	23.306	C V	--	MAR
					• 2004	MTZ
					6018	PAN
					6027	RO3
					7035	BIMCL
					AMA	NRMCL
					ANT	OXI
					AZZ	
					1001	
					BIA	
					BLU	
					GIA	

**Colonna a 4 vie**  
4-way column

**11.10** Tubo ovale inclinato  
Slanted oval tubular bar

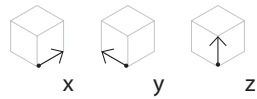
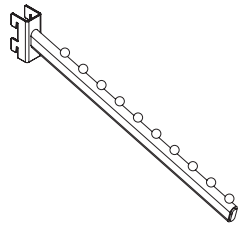

x	y	z	codice code
--	35	--	23.307

note	notes	finitura finish	colori colours	colori colours
		<b>C V</b>		
		• ---		MAR
		2004		MTZ
		6018		PAN
		6027		RO3
		7035		BIMCL
		AMA		NRMCL
		ANT		OXI
		AZZ		
		1001		
		BIA		
		BLU		
		GIA		

**Colonna a 4 vie**  
4-way column

**11.11** Tubo ovale a semicerchio  
Semicircular oval bar

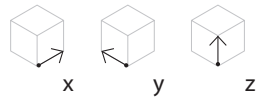
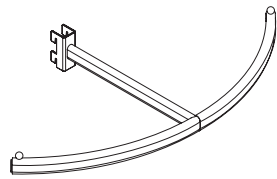

x	y	z	codice code
60	26	--	23.314

note	notes	finitura finish	colori colours	colori colours
		<b>C V</b>		
		• ---		MAR
		2004		MTZ
		6018		PAN
		6027		RO3
		7035		BIMCL
		AMA		NRMCL
		ANT		OXI
		AZZ		
		1001		
		BIA		
		BLU		
		GIA		

**Colonna a 4 vie**  
4-way column

**11.12** Tubo ovale a 90°  
Oval tubular bar 90°

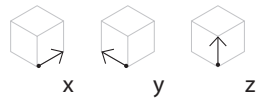
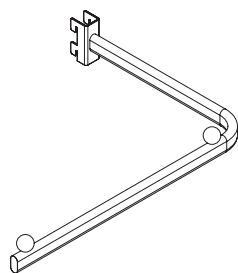
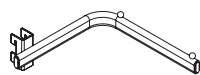

x	y	z	codice code
20	22	--	23.309

dx rh	41	27	--	23.310
sx lh	41	27	--	23.311

note	notes	finitura finish	colori colours	colori colours
		<b>C V</b>		
		• ---		MAR
		2004		MTZ
		6018		PAN
		6027		RO3
		7035		BIMCL
		AMA		NRMCL
		ANT		OXI
		AZZ		
		1001		
		BIA		
		BLU		
		GIA		



Colonna a 4 vie  
4-way column

11.13

Tubo ovale a 90° inclinato  
Slanted oval tubular bar 90°

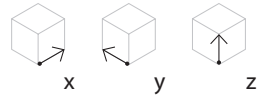
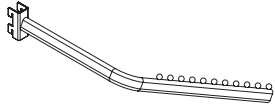

	x	y	z	codice code
dx rh	41	27	--	23.312
sx lh	41	27	--	23.313

note  
notes

finitura  
finish

colori  
colours

colori  
colours

C	V		
•		---	MAR
		2004	MTZ
		6018	PAN
		6027	RO3
		7035	BIMCL
		AMA	NRMCL
		ANT	OXI
		AZZ	
		1001	
		BIA	
		BLU	
		GIA	



Colonna a 4 vie  
4-way column

11.14

Tubo ovale a due livelli  
Two-level oval tubular bar

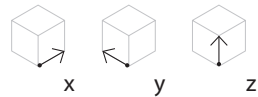
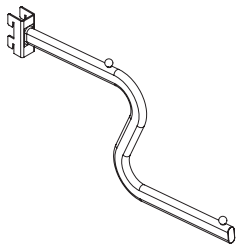

	x	y	z	codice code
	--	38	19	23.308

note  
notes

finitura  
finish

colori  
colours

colori  
colours

C	V		
•		---	MAR
		2004	MTZ
		6018	PAN
		6027	RO3
		7035	BIMCL
		AMA	NRMCL
		ANT	OXI
		AZZ	
		1001	
		BIA	
		BLU	
		GIA	



Colonna a 4 vie  
4-way column

11.15

Tubo tondo a due livelli con portaprezzi  
Two-level rounded tubular bar

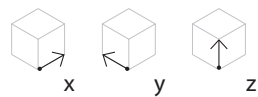
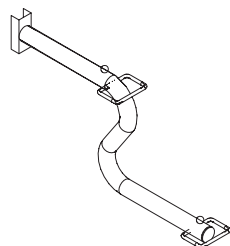

	x	y	z	codice code
	--	38	19	23.441

note  
notes

finitura  
finish

colori  
colours

colori  
colours

C	V		
•		---	MAR
		2004	MTZ
		6018	PAN
		6027	RO3
		7035	BIMCL
		AMA	NRMCL
		ANT	OXI
		AZZ	
		1001	
		BIA	
		BLU	
		GIA	

**Colonna a 4 vie  
4-way column** **11.16** **Tubo tondo a 90° con portaprezzo**  
**Two-level rounded tubular bar**

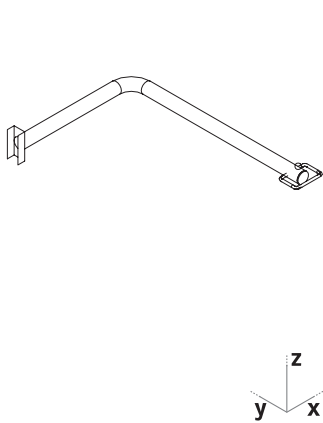

	x	y	z	codice code	note notes	finitura finish	colori colours	colori colours
dx rh	41	27	--	23.448	C	C v		
						•	---	MAR
							2004	MTZ
							6018	PAN
							6027	RO3
							7035	BIMCL
							AMA	NRMCL
							ANT	OXI
							AZZ	
							1001	
							BIA	
							BLU	
							GIA	

**Colonna a 4 vie  
4-way column** **11.17** **Tubo tondo con portaprezzo**  
**Two-level rounded tubular bar**

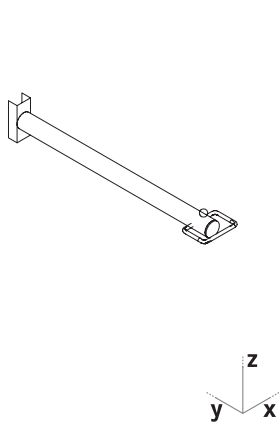

	x	y	z	codice code	note notes	finitura finish	colori colours	colori colours
	41	27	--	23.452	C	C v		
						•	---	MAR
							2004	MTZ
							6018	PAN
							6027	RO3
							7035	BIMCL
							AMA	NRMCL
							ANT	OXI
							AZZ	
							1001	
							BIA	
							BLU	
							GIA	

**Colonna a 4 vie  
4-way column** **11.18** **Gancio per colonna a 4 vie con supporto portacartellino**  
**Single hook for 4-way column with price holder**

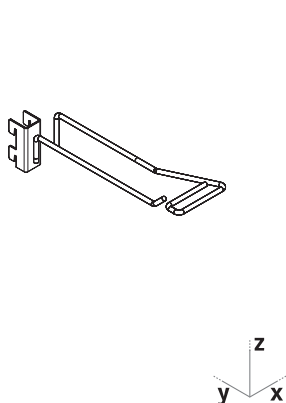

	x	y	z	codice code	finitura e colore finish & colour	note notes
	--	20	--	23.455	C	

Composizione per espositore per passeggini  
*Strollers display*

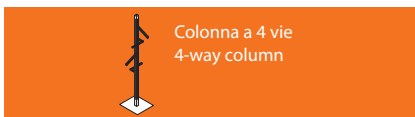
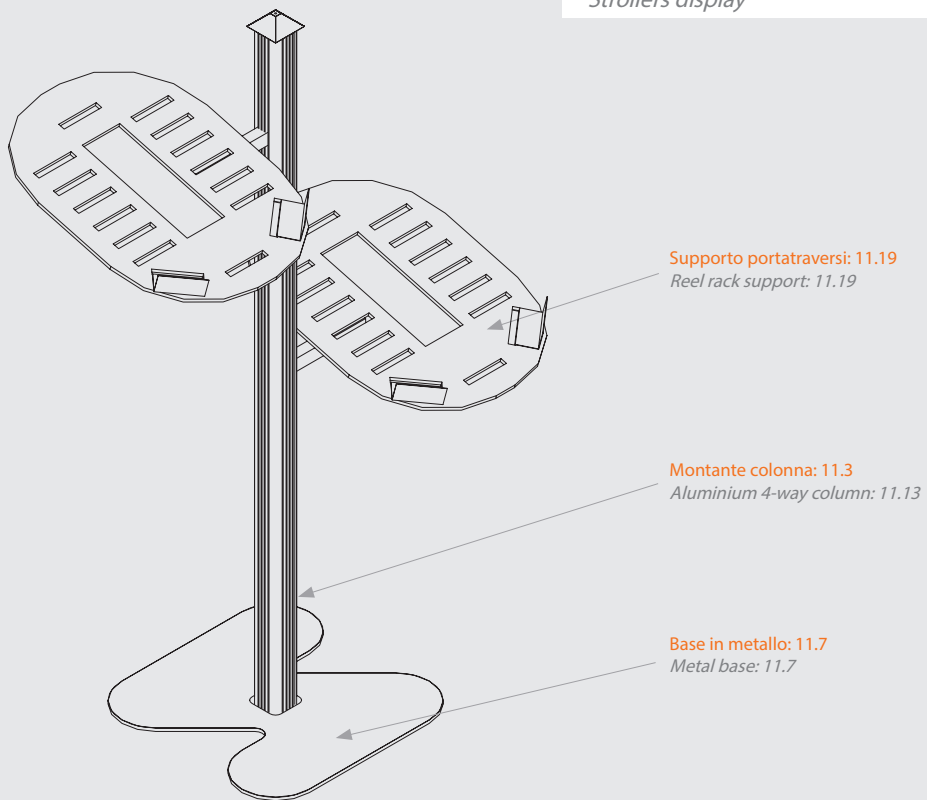

11.19

Kit espositore passeggini  
Strollers display

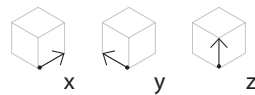
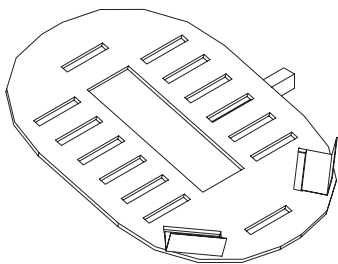

codice code	note notes
-- 22.514	

finitura finish	colori colours
	V
	2004
	6018
	6027
	• 7035
	AMA
	• ANT
	AZZ
	1001
	• BIA
	BLU
	GIA
	MAR
	• MTZ
	• PAN
	RO3
	BIMCL
	• NRMCL
	• OXI



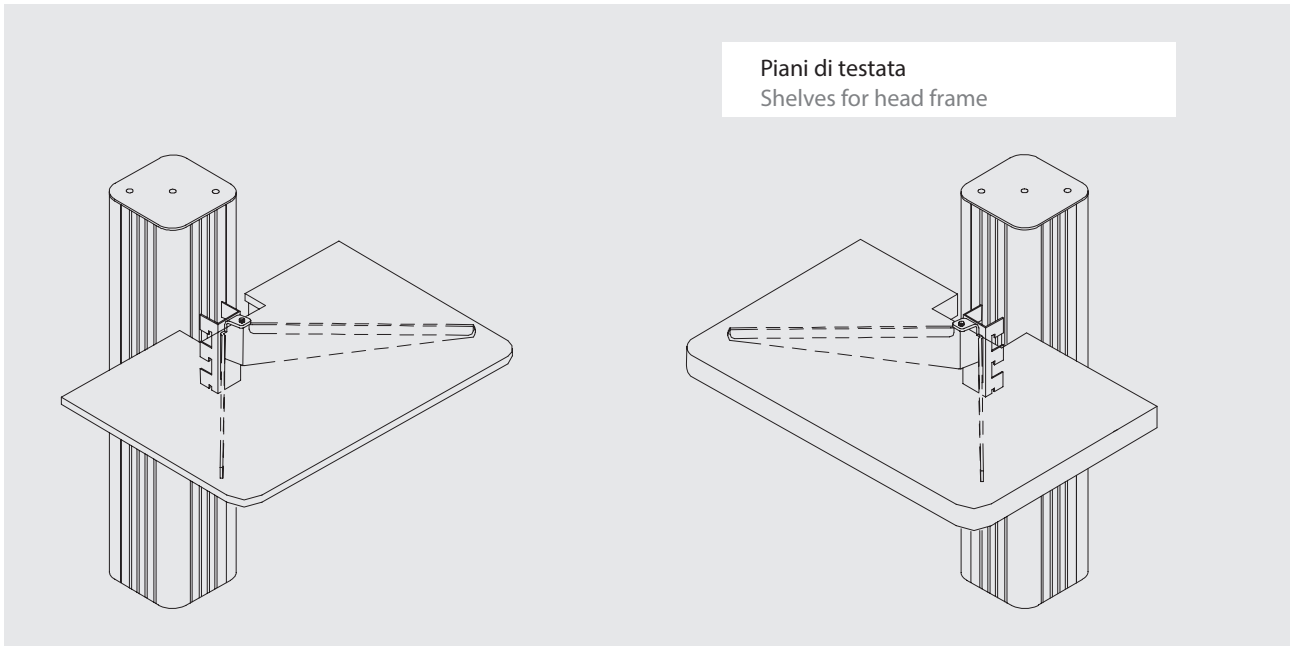

Piani di testata  
Shelves for head frame

**Colonna a 4 vie**  
4-way column

**11.20** Mensola a V per piano di testata in vetro o in legno  
V shaped bracket for head frame shelves

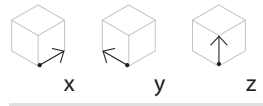
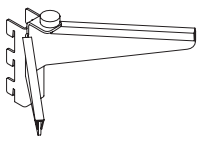

x	y	z	codice code	note notes
--	22,5	15	16.313	

finitura finish	colori colours
	V
	2004
	6018
	6027
	• 7035
	AMA
	• ANT
	AZZ
	1001
	• BIA
	BLU
	GIA
	MAR
	• MTZ
	• PAN
	RO3
	BIMCL
	NRMCL
	• OXI

**Colonna a 4 vie**  
4-way column

**11.21** Piano di testata in vetro  
Glass shelf for head frames

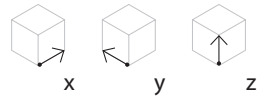
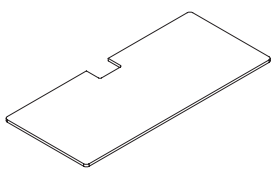

x	y	z	codice code	note notes
68	35	--	17.637	
78	35	--	17.638	

finitura finish	colori colours
T	NT
•	BIAT
	• --

NT trasparente temprato  
TBIAT sabbiato temprato  
NT transparent tempered  
TBIAT opaque tempered



Colonna a 4 vie  
4-way column

11.22

Piano di testata in legno  
Wooden shelf for head frames

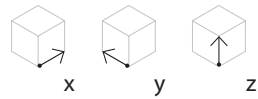
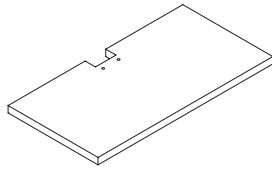

x	y	z	codice code	note notes
68	35	--	17.639	
78	35	--	17.640	

finitura finish	colori colours
T	
•	7035
•	ACE
•	BIA
•	FAG
•	MTZ
•	PAN
•	A439
•	ANT
	K101
	3813
	2293
	990XA
	990XM
	A838
	999XA
	995XM
	989XR
	994XS
	997XS
	983XR
	984XA
	BLACK
	GREEN
	BEIGE
	WHITE



Colonna a 4 vie  
4-way column

11.23

Telaio di testata per fondale  
Head frame for back panel

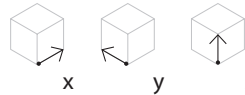
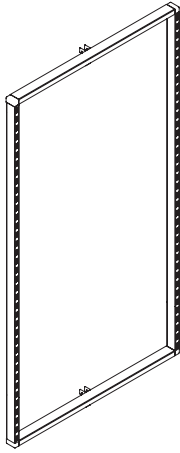

x	y	z	codice code	note notes
75	4	141	21.267	

finitura finish	colori colours
V	2004
	6018
	6027
•	7035
•	AMA
•	ANT
	AZZ
	1001
•	BIA
	BLU
	GIA
	MAR
•	MTZ
•	PAN
	RO3
	BIMCL
	NRMCL
•	OXI



Colonna a 4 vie  
4-way column

11.24

Fondale in legno per telaio di testata  
Wooden back panel

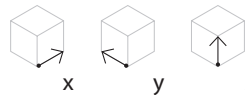
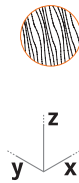
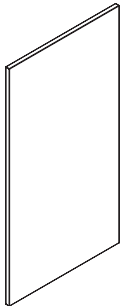

x	y	z	codice code	note notes	finitura finish	colori colours	colori colours
73,2	2,5	136,8	13.256		T		

•	7035	A838
•	ACE	999XA
•	BIA	995XM
	FAG	989XR
•	MTZ	994XS
•	PAN	997XS
•	A439	983XR
•	ANT	984XA
	K101	BLACK
	3813	GREEN
	2293	BEIGE
	990XA	WHITE
	990XM	



Colonna a 4 vie  
4-way column

11.25

Fondale in legno con specchio per telaio di testata  
Full high mirror back panel

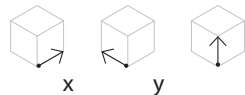
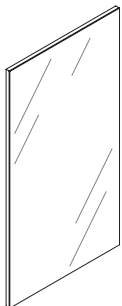

x	y	z	codice code	note notes	finitura finish	colori colours	colori colours
73,2	3,1	136,8	13.257		T		

•	7035	A838
•	ACE	999XA
•	BIA	995XM
	FAG	989XR
•	MTZ	994XS
•	PAN	997XS
•	A439	983XR
•	ANT	984XA
	K101	BLACK
	3813	GREEN
	2293	BEIGE
	990XA	WHITE
	990XM	

**Colonna a 4 vie**  
4-way column

**11.26** Supporto per fondale  
Support for back panel



Colonna a 4 vie  
4-way column

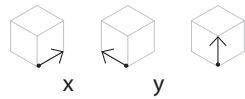

x	y	z	codice code	note notes
--	--	135	34.444	

finitura finish	colori colours
V	2004
	6018
	6027
•	7035
	AMA
•	ANT
	AZZ
	1001
•	BIA
	BLU
	GIA
	MAR
•	MTZ
•	PAN
	RO3
	BIMCL
	NRMCL
•	OXI

**Colonna a 4 vie**  
4-way column

**11.27** Fondale in filo (maglia 10x5)  
Wired back panel (mesh 10x5)



Colonna a 4 vie  
4-way column

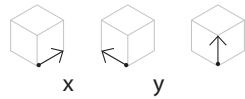
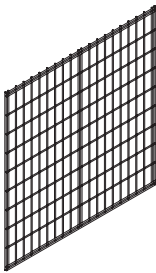

x	y	z	codice code	note notes
92	--	43,6	13.268	
92	--	90,4	13.267	

finitura finish	colori colours
V	2004
	6018
	6027
•	7035
	AMA
•	ANT
	AZZ
	1001
•	BIA
	BLU
	GIA
	MAR
•	MTZ
•	PAN
	RO3
	BIMCL
	NRMCL
•	OXI

**Colonna a 4 vie**  
4-way column

**11.28** Fondale in legno  
Wooden back panel



Colonna a 4 vie  
4-way column

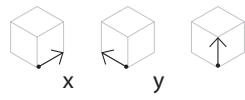
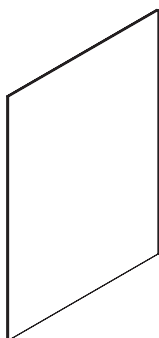

x	y	z	codice code	note notes
92	--	138	13.269	

finitura finish	colori colours	colori colours
T		
•	7035	A838
•	ACE	999XA
•	BIA	995XM
	FAG	989XR
•	MTZ	994XS
•	PAN	997XS
•	A439	983XR
•	ANT	984XA
	K101	BLACK
	3813	GREEN
	2293	BEIGE
	990XA	WHITE
	990XM	



Colonna a 4 vie  
4-way column

11.29

Traverso tubolare di collegamento fra due colonne  
Tubular crosspiece

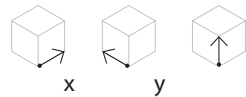
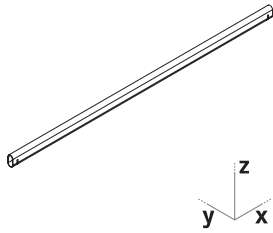

x	y	z	codice code
91,8	1,8	3,6	23.296

note  
notes

finitura  
finish

colori  
colours

colori  
colours

V		colori colours	colori colours
		2004	MAR
		6018	• MTZ
		6027	• PAN
	•	7035	RO3
		AMA	BIMCL
	•	ANT	NRMCL
		AZZ	• OXI
		1001	GIA
	•	BIA	
		BLU	

Mensola di aggancio del traverso tubolare  
Support for tubular crosspiece

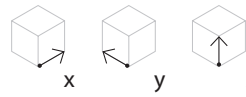
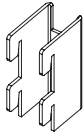

x	y	z	codice code
2,5	--	6	23.305

note  
notes

finitura  
finish

colori  
colours

C	V	colori colours
		2004
		6018
		6027
		7035
		AMA
		ANT
		AZZ
		1001
		BIA
		BLU
		GIA
		MAR
		MTZ
		PAN
		RO3
		BIMCL
		NRMCL
		OXI
•		---



Colonna a 4 vie  
4-way column

11.30

Mensola per piano di collegamento  
Shelf bracket

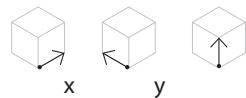
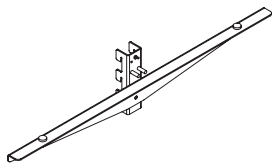

	x	y	z	codice code
per vetro for glass	--	53	--	16.311
per legno for wood	--	53	--	16.312

note  
notes

finitura  
finish

colori  
colours

colori  
colours

V		colori colours	colori colours
		2004	MAR
		6018	• MTZ
		6027	• PAN
	•	7035	RO3
		AMA	BIMCL
	•	ANT	NRMCL
		AZZ	• OXI
		1001	GIA
	•	BIA	
		BLU	

**Colonna a 4 vie  
4-way column** **11.31** **Piano di collegamento in vetro  
Glass shelf**

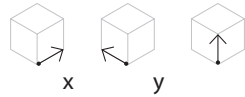
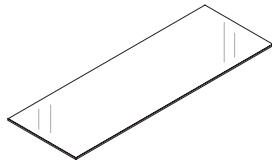

x	y	z	codice code
100	30	0,8	17.633
100	35	0,8	17.634

note  
notes

finitura finish		colori colours	
T	N		
•			BIA
	•		-

**Colonna a 4 vie  
4-way column** **11.32** **Piano di collegamento in legno  
Wooden shelf**

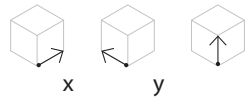
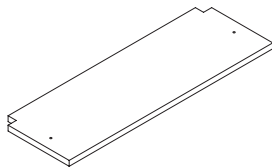

x	y	z	codice code
100	30	2,5	17.635
100	35	2,5	17.636

note  
notes

finitura finish		colori colours	
T	N		
•			7035
•			ACE
•			BIA
•			FAG
•			MTZ
•			PAN
•			A439
•			ANT
			K101
			3813
			2293
			990XA
			990XM
			A838
			999XA
			995XM
			989XR
			994XS
			997XS
			983XR
			984XA
			BLACK
			GREEN
			BEIGE
			WHITE

# Montante in tubo 3x3

## Elementi a parete

# Tubular upright 3x3

## Wall Bays

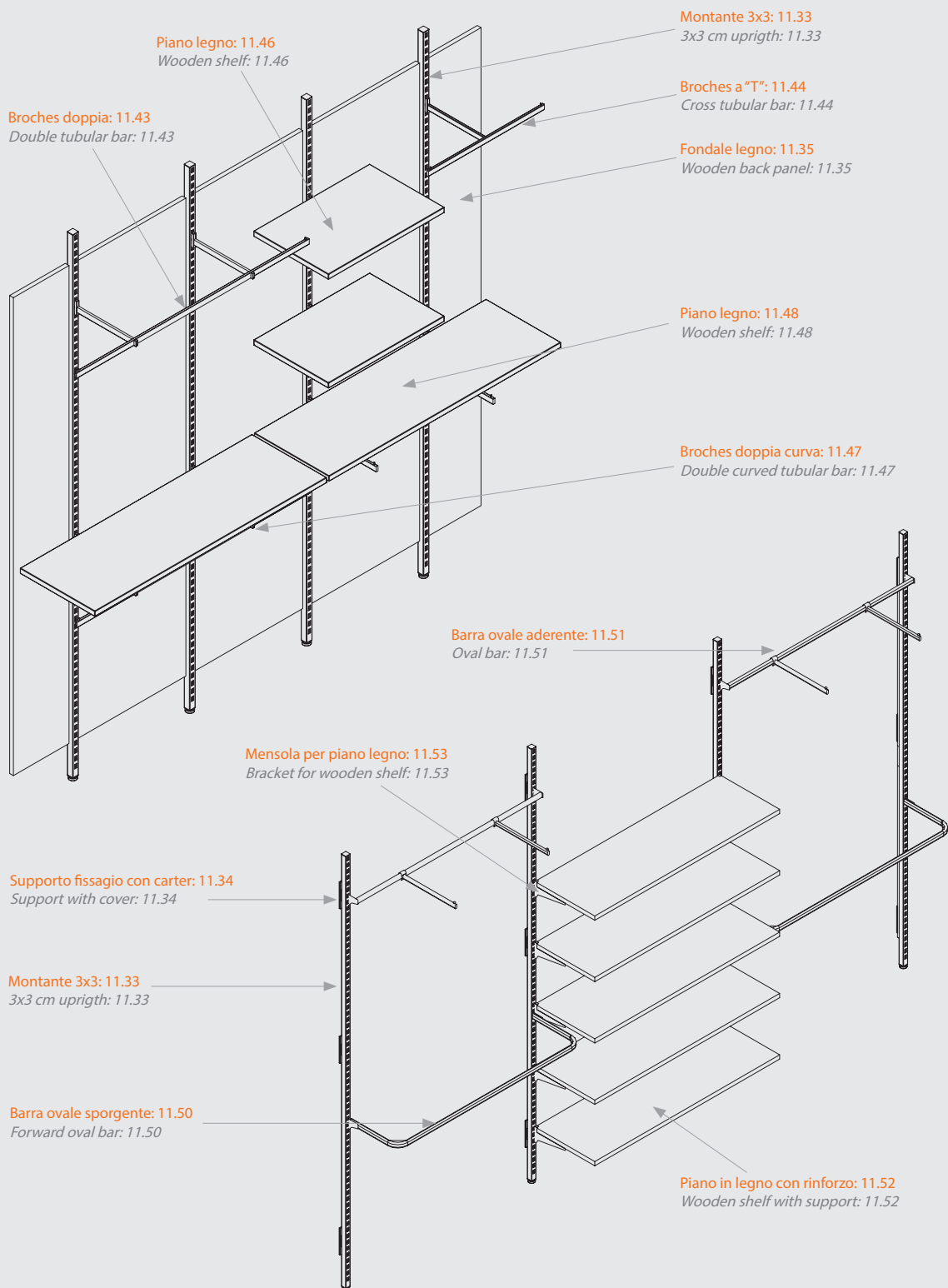

Montante 3x3  
3x3 Upright

11.33

Montante in tubo 3x3 per elementi a parete  
Tubular upright for wall bay

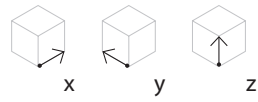

x	y	z	codice code	note notes
3	3	252	10.420	

finitura finish	colori colours
V	2004
	6018
	6027
	• 7035
	AMA
	• ANT
	AZZ
	1001
	• BIA
	BLU
	GIA
	MAR
	• MTZ
	• PAN
	RO3
	BIMCL
	NRMCL
	• OXI



Montante 3x3  
3x3 Upright

11.34

Supporto per fissaggio a parete  
Support for wall fixing



x	y	z	codice code	note notes
3	--	10	34.676	

finitura finish	colori colours
V	2004
	6018
	6027
	• 7035
	AMA
	• ANT
	AZZ
	1001
	• BIA
	BLU
	GIA
	MAR
	• MTZ
	• PAN
	RO3
	BIMCL
	NRMCL
	• OXI





Montante 3x3  
3x3 Upright

11.35

Fondale per elementi a parete con predisposizione per fissaggio  
Wooden panel for wall bay with fixing system

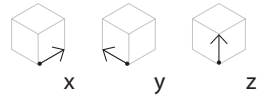

x	y	z	codice code	note notes
62	2,5	216	13.567	



finitura finish	colori colours
T	
•	7035
•	ACE
•	BIA
•	FAG
•	MTZ
•	PAN
•	A439
•	ANT
	K101
	3813
	2293
	990XA
	990XM
	A838
	999XA
	995XM
	989XR
	994XS
	997XS
	983XR
	984XA
	BLACK
	GREEN
	BEIGE
	WHITE

# Montante in tubo 3x3 Elementi gondola

## Tubular upright 3x3 Gondola bays

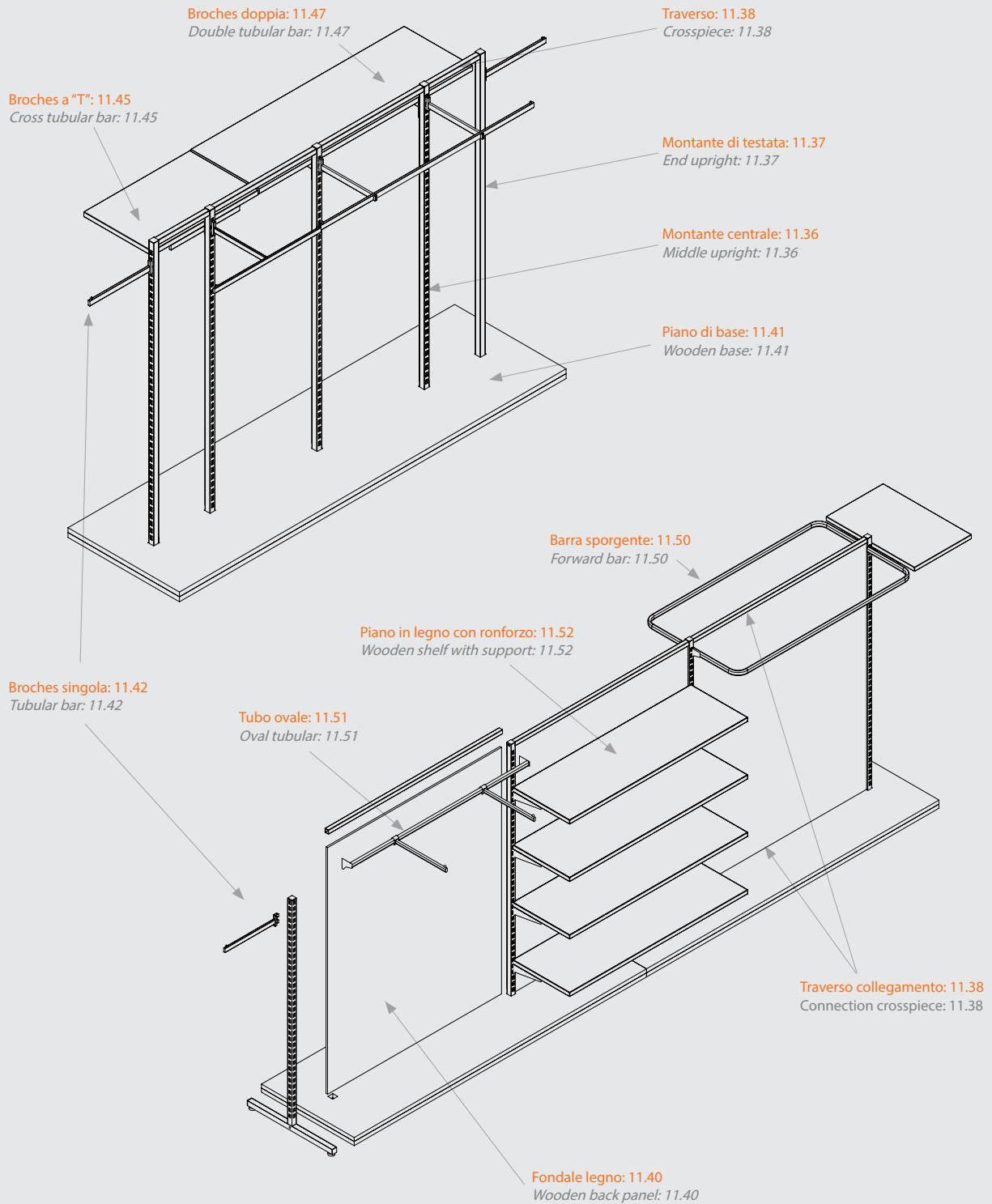

### Composizione gondola per moduli passo 62,5 Displays setting for 62,5 gondola units

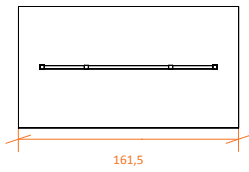

RIF. A

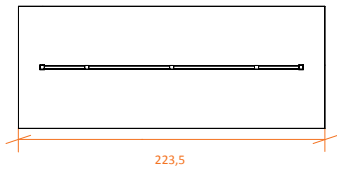

RIF. B

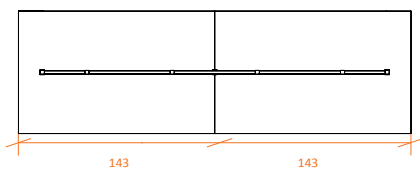

RIF. C

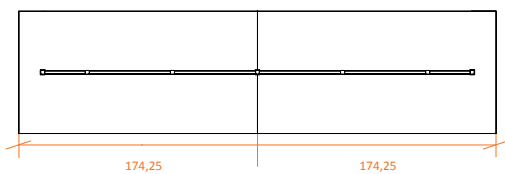

RIF. D

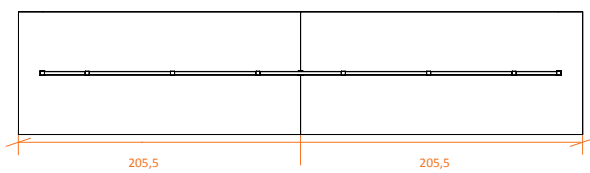

RIF. E

### Composizione gondola per moduli passo 125 Displays setting for 125 gondola units

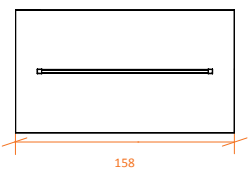

RIF. F

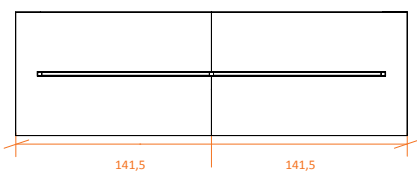

RIF. G

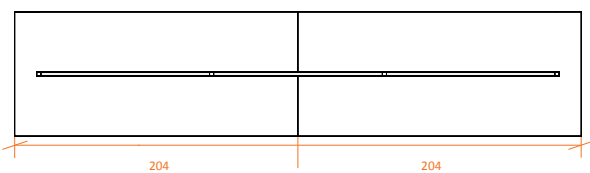

RIF. H

Sistema ad incastro per fondale legno: 11.40  
Joint system for wooden panel: 11.40

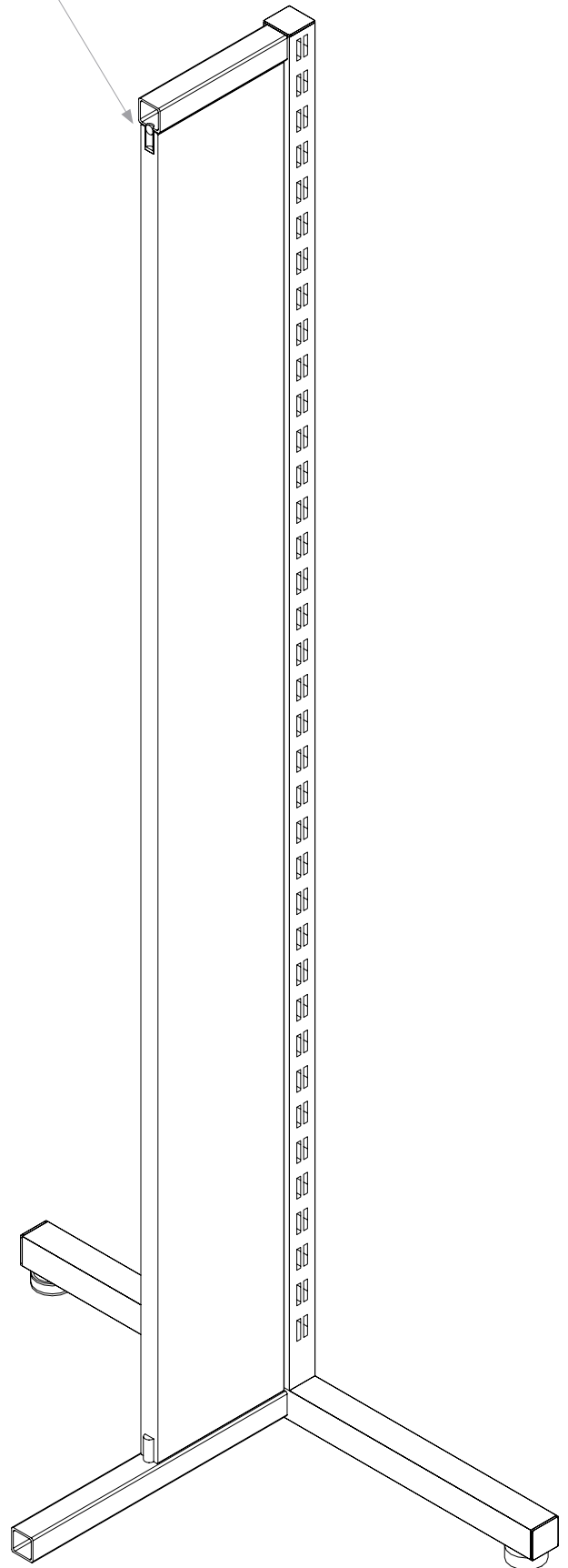



Montante 3x3  
3x3 Upright

11.39

Sistemi di fissaggio per fondali e piani base  
Joint system for wooden panels and foot-base shelves

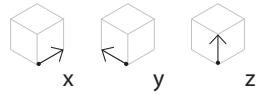
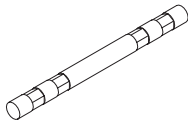

Per fondali  
For panels

-- -- 2,5

codice  
code

FE.262

note  
notes

Per piani base  
For foot-base

5,2 0,8 0,8

FE.-84



Montante 3x3  
3x3 Upright

11.40

Fondale per elementi a gondola  
Wooden backpanel

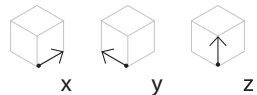

30 2 150,2

codice  
code

13.570

note  
notes

s/pedana

60 2 150,2

13.568

s/pedana

122 2 150,2

13.569

s/pedana

30 2 150

13.635

c/pedana

60 2 150

13.636

c/pedana

122 2 150

13.637

c/pedana

finitura  
finish

T

colori  
colours

•	7035
•	ACE
•	BIA
•	FAG
•	MTZ
•	PAN
•	A439
•	ANT
	K101
	3813
	2293
	990XA
	990XM
	A838
	999XA
	995XM
	989XR
	994XS
	997XS
	983XR
	984XA
	BLACK
	GREEN
	BEIGE
	WHITE

x y z

codice  
code

13.570

note  
notes

s/pedana

60 2

13.568

s/pedana

122 2

13.569

s/pedana

30 2 150

13.635

c/pedana

60 2 150

13.636

c/pedana

122 2 150

13.637

c/pedana

Montante 3x3  
3x3 Upright

11.41

Piano di base per elementi a gondola  
Wooden base for gondola

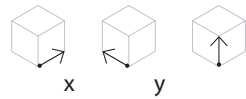
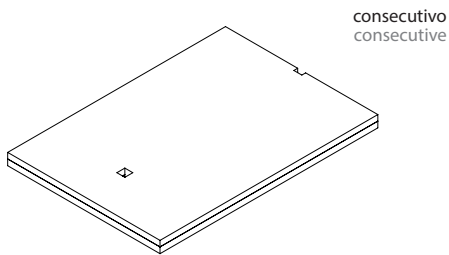
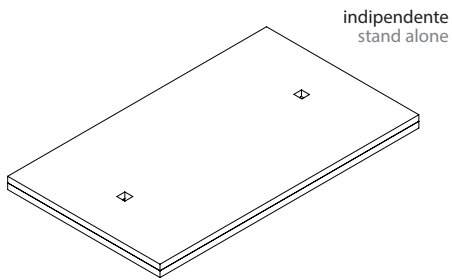

	x	y	z	codice code	note notes
		90	5	40.205	RIF. A
		90	5	40.206	RIF. B
143	90	5	40.207	RIF. C	
	90	5	40.208	RIF. D	
	90	5	40.209	RIF. E	
158	90	5	40.210	RIF. F	
	90	5	40.211	RIF. G	
204	90	5	40.212	RIF. H	

finitura finish	colori colours
T	
•	7035
•	ACE
•	BIA
•	FAG
•	MTZ
•	PAN
•	A439
•	ANT
	K101
	3813
	2293
	990XA
	990XM
	A838
	999XA
	995XM
	989XR
	994XS
	997XS
	983XR
	984XA
	BLACK
	GREEN
	BEIGE
	WHITE

# Montante in tubo 3x3

## Accessori

# Tubular upright 3x3

## Accessories

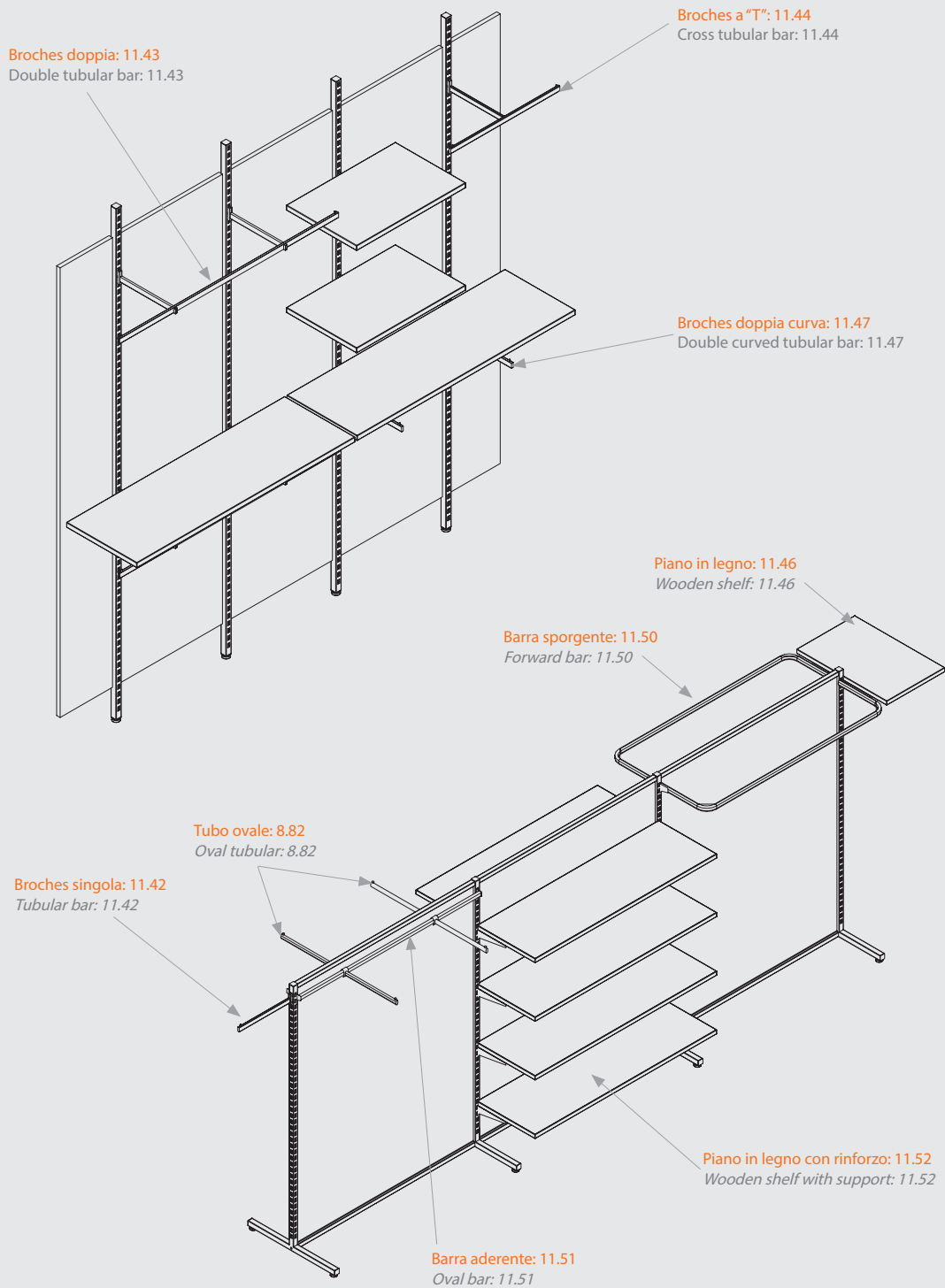

Accessori 3x3  
3x3 Accessories

11.42

Broches singola con fermo  
Tubular bar with stopper

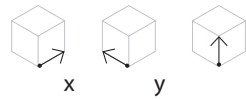
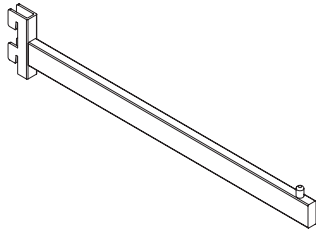

x	y	z	codice code
1	35	3	23.463

note	notes	finitura finish	colori colours	colori colours
		C v		
		•	---	MAR
			2004	MTZ
			6018	PAN
			6027	RO3
			7035	BIMCL
			AMA	NRMCL
			ANT	OXI
			AZZ	
			1001	
			BIA	
			BLU	
			GIA	

Accessori 3x3  
3x3 Accessories

11.43

Broches doppia con fermi  
Double tubular bar with support

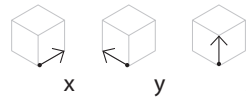
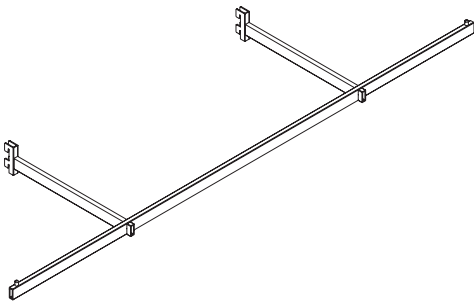

x	y	z	codice code
124	32	3	23.464

note	notes	finitura finish	colori colours	colori colours
		C v		
		•	---	MAR
			2004	MTZ
			6018	PAN
			6027	RO3
			7035	BIMCL
			AMA	NRMCL
			ANT	OXI
			AZZ	
			1001	
			BIA	
			BLU	
			GIA	

Accessori 3x3  
3x3 Accessories

11.44

Broches a "T" con fermi  
Cross tubular bar

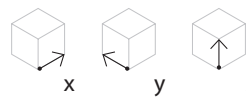
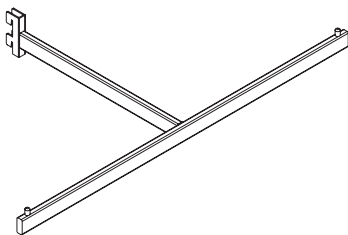

x	y	z	codice code
62	31	3	23.465

note	notes	finitura finish	colori colours	colori colours
		C v		
		•	---	MAR
			2004	MTZ
			6018	PAN
			6027	RO3
			7035	BIMCL
			AMA	NRMCL
			ANT	OXI
			AZZ	
			1001	
			BIA	
			BLU	
			GIA	



Accessori 3x3  
3x3 Accessories

11.45

Broches a "T" per piano legno  
Tubular cross bracket for wooden shelf

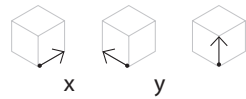
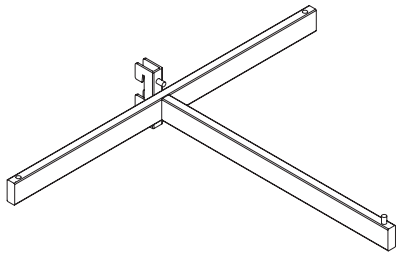

x	y	z	codice code	note notes
40	31	3	23.466	

finitura finish		colori colours	
C	V		
		2004	
		6018	
		6027	
		7035	
		AMA	
		ANT	
		AZZ	
		1001	
		BIA	
		BLU	
		GIA	
		MAR	
		MTZ	
		PAN	
		RO3	
		BIMCL	
		NRMCL	
		OXI	
		---	

Accessori 3x3  
3x3 Accessories

11.46

Piano legno per broches a "T"  
"T" wooden shelf

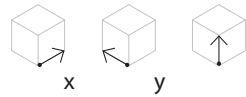
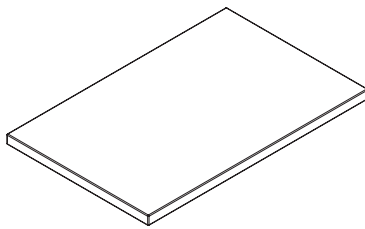

x	y	z	codice code	note notes
62	40	2,5	40.-40	

finitura finish		colori colours	
T			
•		7035	
•		ACE	
•		BIA	
		FAG	
•		MTZ	
•		PAN	
•		A439	
•		ANT	
		K101	
		3813	
		2293	
		990XA	
		990XM	
		A838	
		999XA	
		995XM	
		989XR	
		994XS	
		997XS	
		983XR	
		984XA	
		BLACK	
		GREEN	
		BEIGE	
		WHITE	

Accessori 3x3  
3x3 Accessories

11.47

Broches doppia curva per piano legno  
Tubular curved bar with stopper for wooden shelf

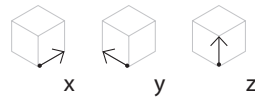
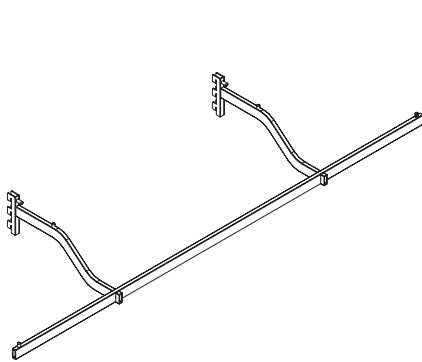

x	y	z	codice code
124	32	--	23.467

note	notes	finitura finish	colori colours	colori colours
		<b>C V</b>		
		• ---		MAR
		2004		MTZ
		6018		PAN
		6027		RO3
		7035		BIMCL
		AMA		NRMCL
		ANT		OXI
		AZZ		
		1001		
		BIA		
		BLU		
		GIA		

Accessori 3x3  
3x3 Accessories

11.48

Piano legno per doppia curva  
Wooden shelf for tubular curved bar

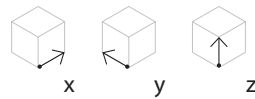
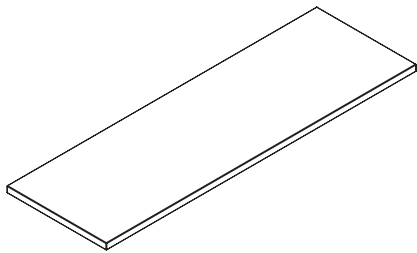

x	y	z	codice code
	40	2,5	40.-39
	50	2,5	40.-42

note	notes	finitura finish	colori colours	colori colours
		<b>T</b>		
		• 7035	A838	
		• ACE	999XA	
		• BIA	995XM	
		FAG	989XR	
		• MTZ	994XS	
		• PAN	997XS	
		• A439	983XR	
		• ANT	984XA	
		K101	BLACK	
		3813	GREEN	
		2293	BEIGE	
		990XA	WHITE	
		990XM		

Accessori 3x3  
3x3 Accessories

11.49

Barra ovale aderente  
Oval bar

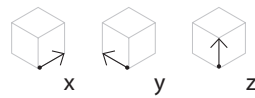
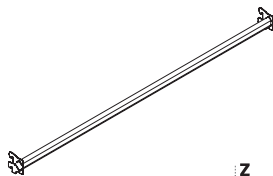

x	y	z	codice code
125	--	--	23.460

note	notes	finitura finish	colori colours	colori colours
		<b>C V</b>		
		• ---		MAR
		2004		MTZ
		6018		PAN
		6027		RO3
		7035		BIMCL
		AMA		NRMCL
		ANT		OXI
		AZZ		
		1001		
		BIA		
		BLU		
		GIA		

Accessori 3x3  
3x3 Accessories

**11.50** Barra ovale sporgente  
*Forward oval bar*

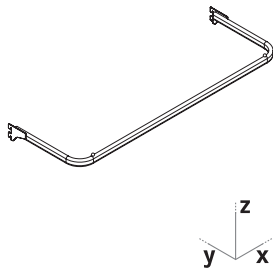

x	y	z	codice code	note notes	finitura finish	colori colours	colori colours
125	30	--	23.461		C V		
						---	MAR
						2004	MTZ
						6018	PAN
						6027	RO3
						7035	BIMCL
						AMA	NRMCL
						ANT	OXI
						AZZ	
						1001	
						BIA	
						BLU	
						GIA	

Accessori 3x3  
3x3 Accessories

**11.51** Barra liscia aderente  
*Rectangular bar*

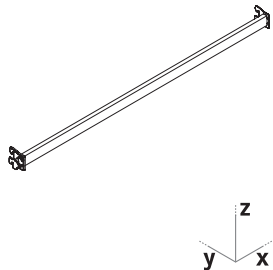

x	y	z	codice code	finitura e colore finish & colour	note notes
125	--	--	23.453	C	

Accessori 3x3  
3x3 Accessories

**11.52** Piano in legno a sbalzo  
*Overhanging wooden shelf*

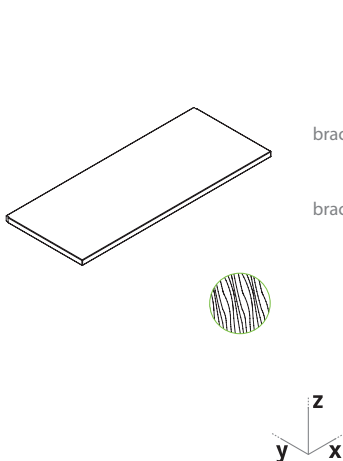

	x	y	z	codice code	note notes	finitura finish	colori colours	colori colours
mensola bracket y=20	125	40	2,5	40.-41		T		
mensola bracket y=45	125	50	2,5	40.-43				
							7035	A838
							ACE	999XA
							BIA	995XM
							FAG	989XR
							MTZ	994XS
							PAN	997XS
							A439	983XR
							ANT	984XA
							K101	BLACK
							3813	GREEN
							2293	BEIGE
							990XA	WHITE
							990XM	

Accessori 3x3  
3x3 Accessories

11.53

Mensola con piolino per piano in legno a sbalzo  
*Bracket for overhanging wooden shelf*

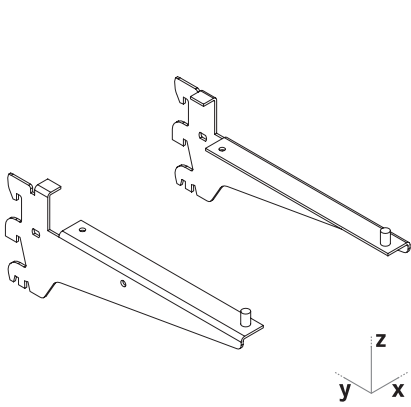

	x	y	z	codice code	note notes
dx rh	--	20	--	16.432	
sx lh	--	20	--	16.433	
dx rh	--	45	--	16.439	
sx lh	--	45	--	16.440	

finitura finish	colori colours
V	
	2004
	6018
	6027
	• 7035
	AMA
	• ANT
	AZZ
	1001
	• BIA
	BLU
	GIA
	MAR
	• MTZ
	• PAN
	RO3
	BIMCL
	NRMCL
	• OXI

Accessori 3x3  
3x3 Accessories

11.54

Mobile base con ante scorrevoli  
*Base cabinet with sliding doors*

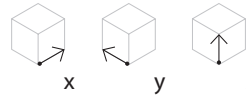
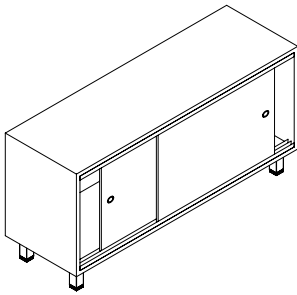

	x	y	z	codice code
	42	50	21.349	
	52	50	21.350	

note  
notes

finitura  
finish

colori  
colours

colori  
colours

note	finitura	colori	colori
notes	finish	colours	colours
T			
•	7035	A838	
•	ACE	999XA	
•	BIA	995XM	
	FAG	989XR	
•	MTZ	994XS	
•	PAN	997XS	
•	A439	983XR	
•	ANT	984XA	
	K101	BLACK	
	3813	GREEN	
	2293	BEIGE	
	990XA	WHITE	
	990XM		

Accessori 3x3  
3x3 Accessories

11.55

Mobile base a 2 cassetti  
*Base cabinet with 2 drawers*

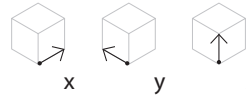
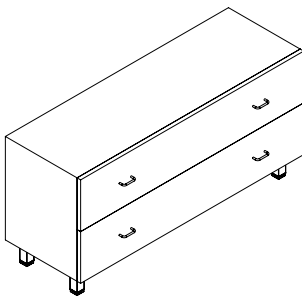

	x	y	z	codice code
	42	50	21.345	
	52	50	21.346	

note  
notes

finitura  
finish

colori  
colours

colori  
colours

note	finitura	colori	colori
notes	finish	colours	colours
T			
•	7035	A838	
•	ACE	999XA	
•	BIA	995XM	
	FAG	989XR	
•	MTZ	994XS	
•	PAN	997XS	
•	A439	983XR	
•	ANT	984XA	
	K101	BLACK	
	3813	GREEN	
	2293	BEIGE	
	990XA	WHITE	
	990XM		

Accessori 3x3  
3x3 Accessories

11.56

Mobile base a 3 cassetti  
*Base cabinet with 3 drawers*

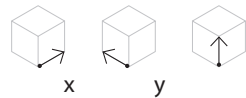
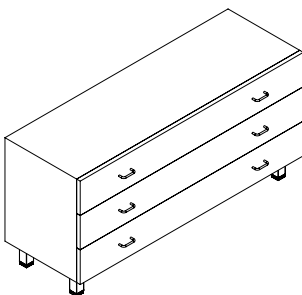

	x	y	z	codice code
	42	50	21.347	
	52	50	21.348	

note  
notes

finitura  
finish

colori  
colours

colori  
colours

note	finitura	colori	colori
notes	finish	colours	colours
T			
•	7035	A838	
•	ACE	999XA	
•	BIA	995XM	
	FAG	989XR	
•	MTZ	994XS	
•	PAN	997XS	
•	A439	983XR	
•	ANT	984XA	
	K101	BLACK	
	3813	GREEN	
	2293	BEIGE	
	990XA	WHITE	
	990XM		

**note**  
*notes*

**note**  
*notes*

Tamponamenti e finiture  
*Covering and finishing*

12

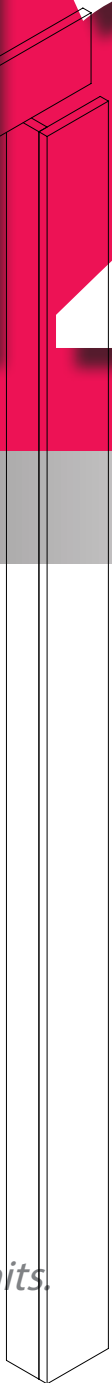
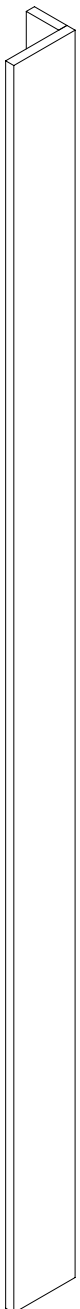

Pannelli e finiture terminali.  
*Panels and covers for end and gondola units.*





Elementi a gondola con finiture di testata per supporto a testa tonda  
Gondola units with end finishings for round head supports

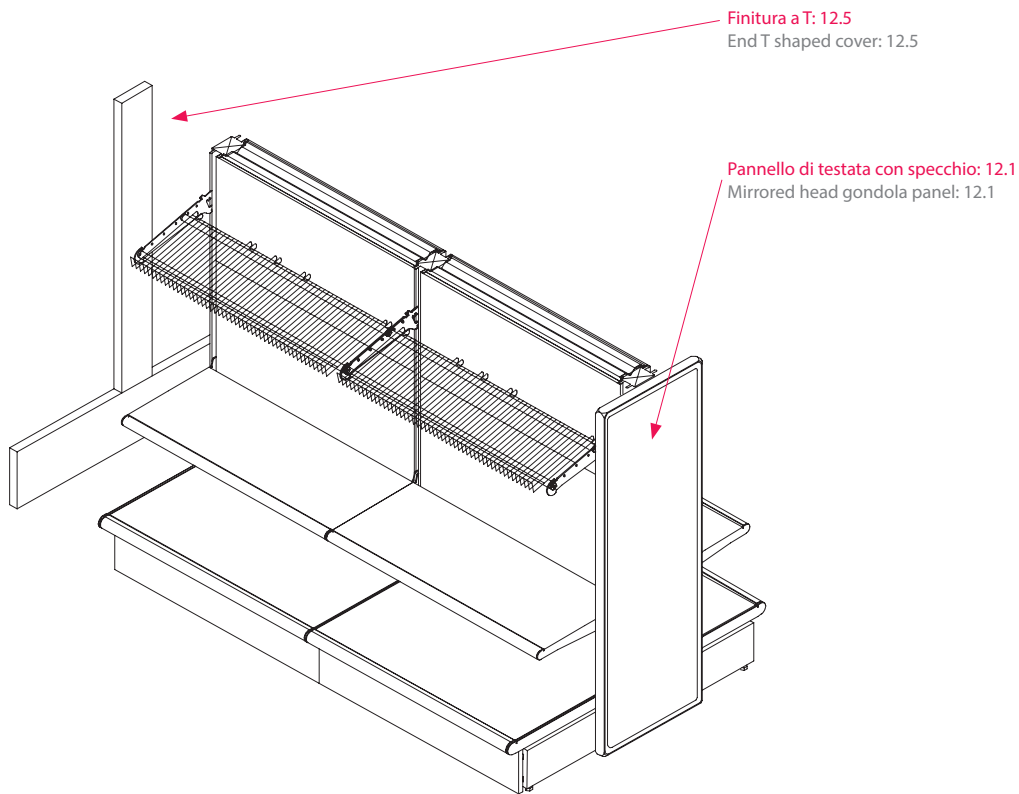

Elementi a gondola con finiture di testata per piano pedana  
Gondola units with end finishings for platform top

Finitura a T: 12.3  
End T shaped cover: 12.3

Finitura per elementi terminali: 12.2  
End wooden cover: 12.2

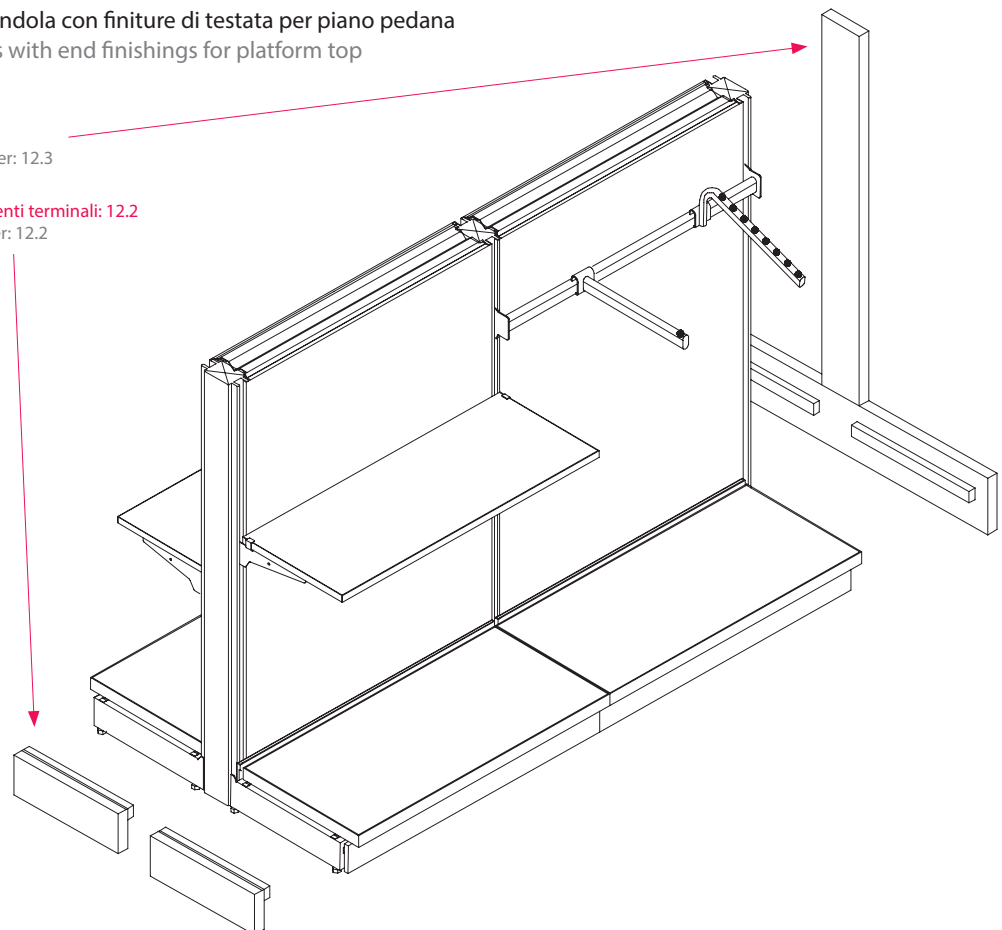

Elementi a parete con finiture di testata  
Wall units with end finishings

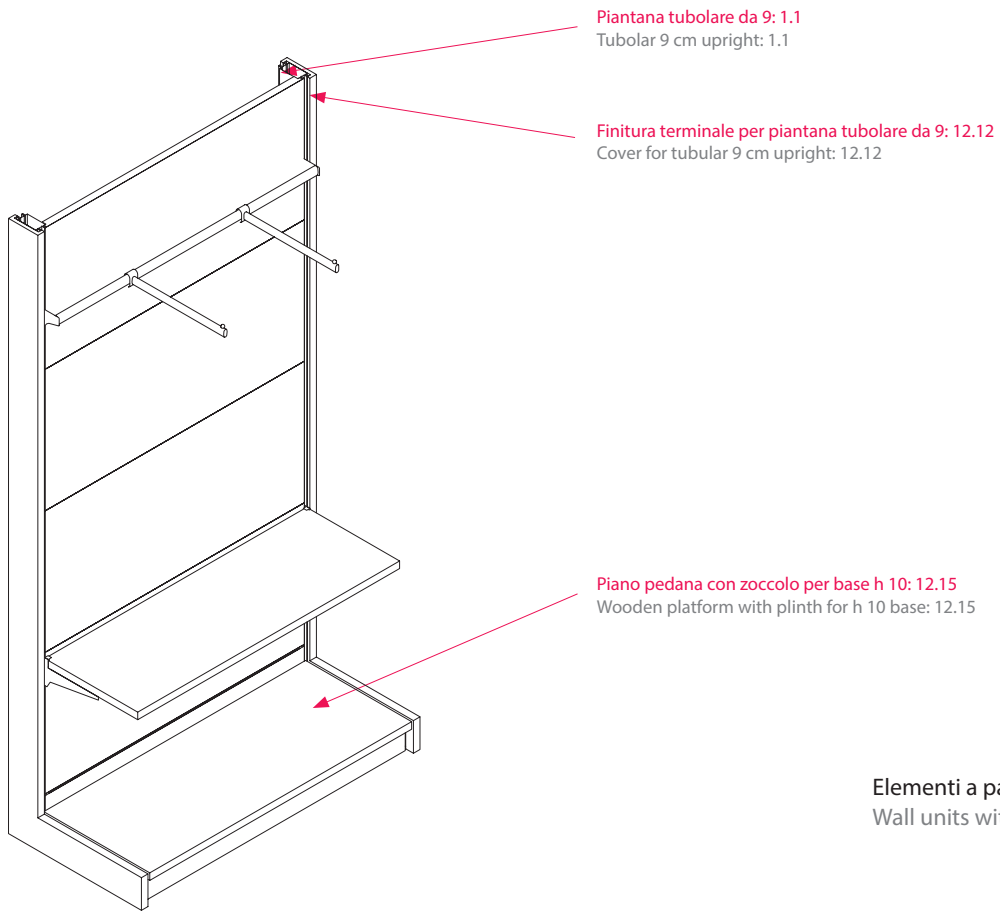

Elementi a parete con finiture di testata  
Wall units with end finishings

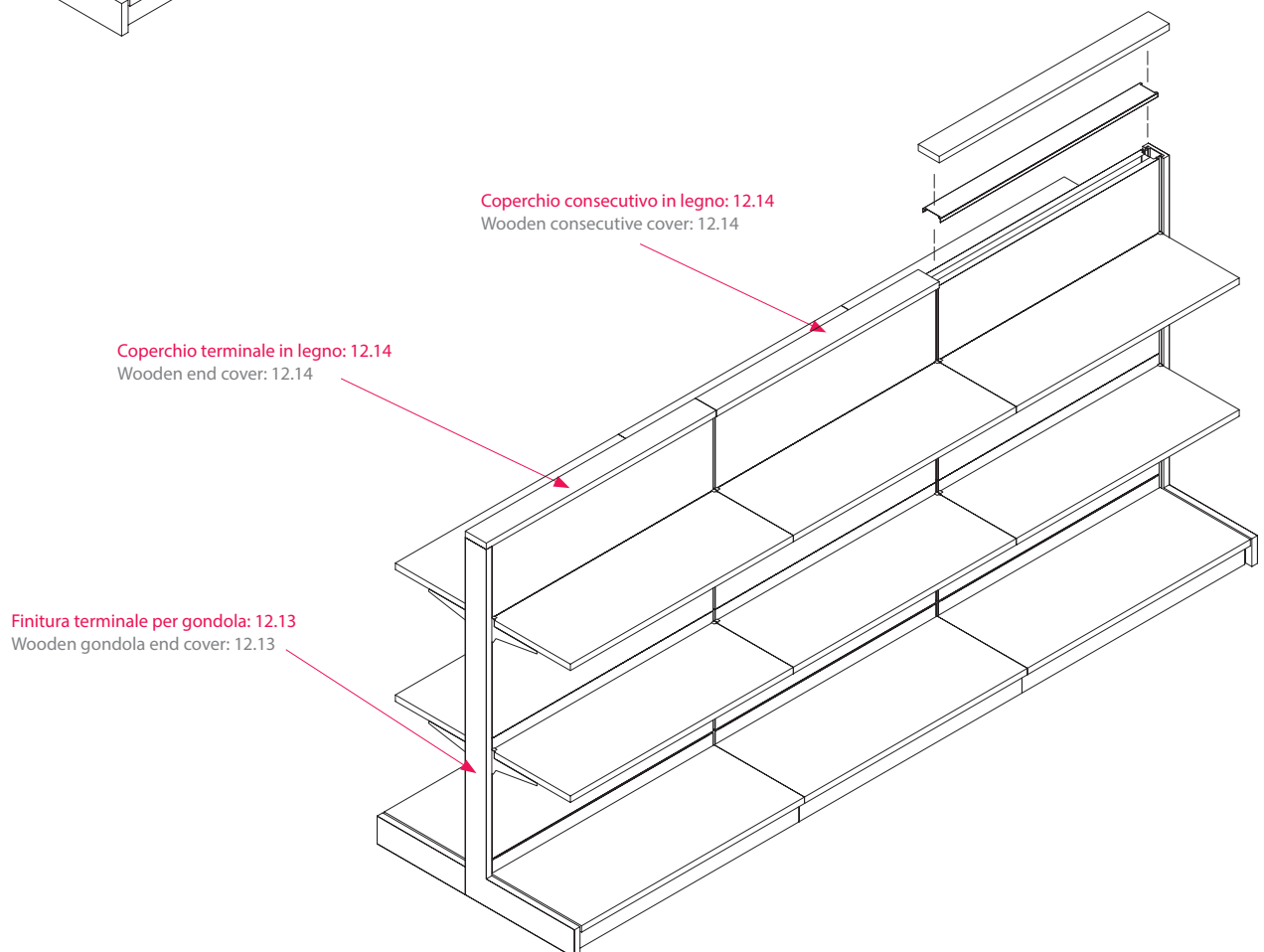

**Tamponamento per elementi a parete h 252 con pedana per base h 10**  
Wooden frame for wall bay h 252 with platform and footbase h 10

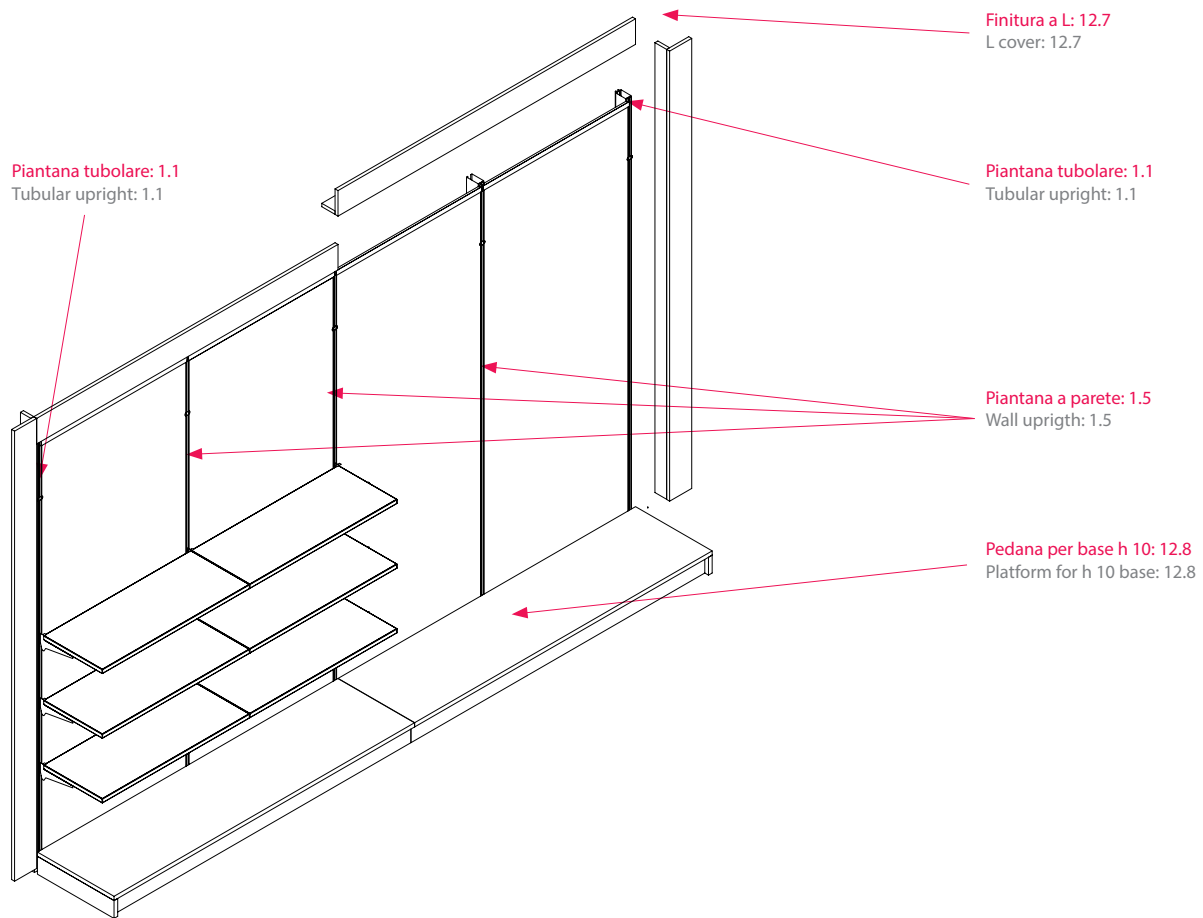

**Tamponamento per elementi a gondola h 122 x 7,2 con pedana per base h 10**  
Wooden frame for gondola bay h 122 with platform and footbase h 10

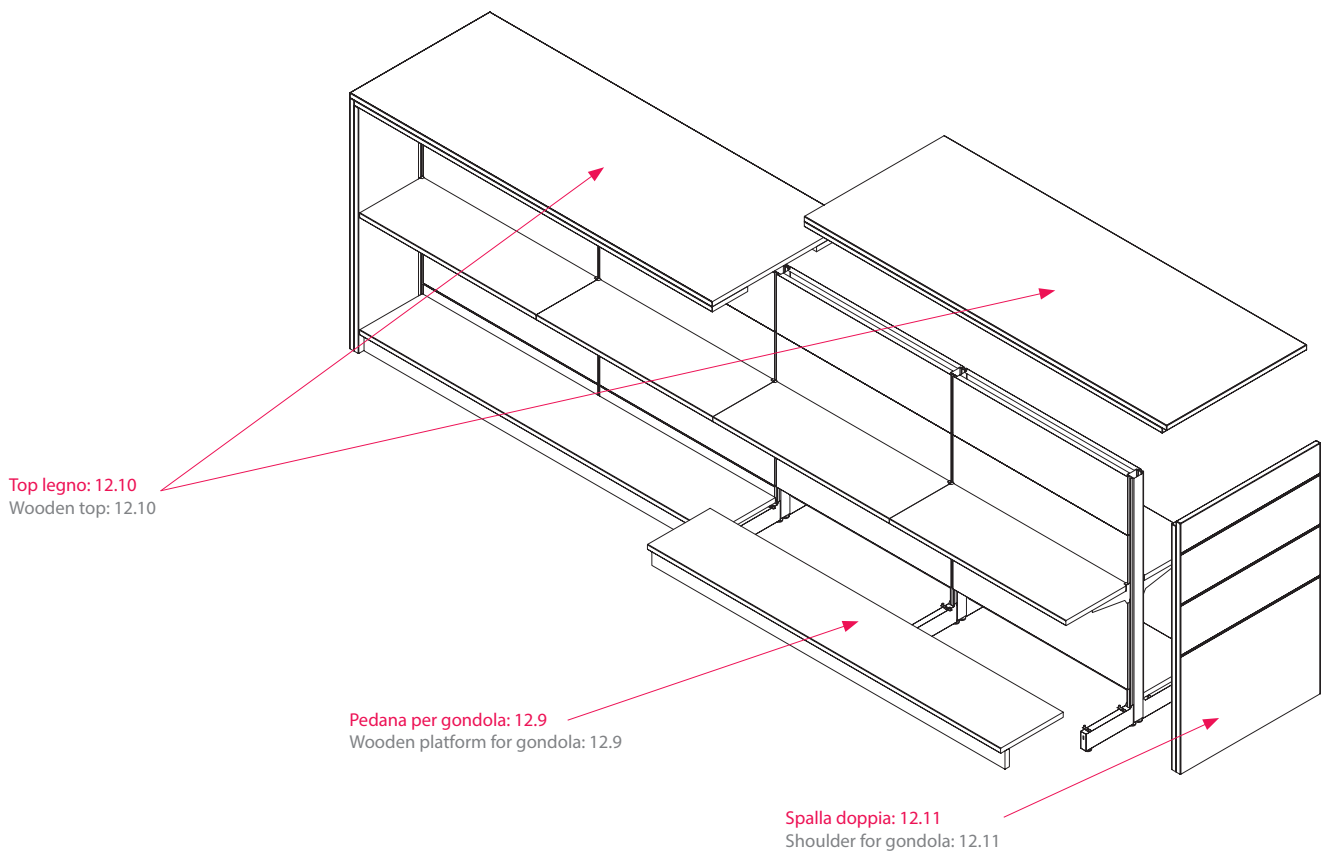



Tamponamenti e finiture  
Covering and finishing

12.1

Pannello di testata per gondola con specchio  
Mirrored head gondola panel

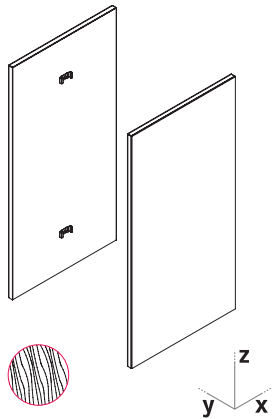

	x	y	z	codice code	note notes	finitura finish	colori colours	colori colours
piantana upright y=7,2	72	3	122	30.218		<b>T</b>		
	72	3	140	30.219		•	7035	A838
						•	ACE	999XA
						•	BIA	995XM
							FAG	989XR
						•	MTZ	994XS
						•	PAN	997XS
						•	A439	983XR
						•	ANT	984XA
							K101	BLACK
							3813	GREEN
							2293	BEIGE
							990XA	WHITE
							990XM	



Tamponamenti e finiture  
Covering and finishing

12.2

Finitura per elementi terminali con piano pedana  
End wooden cover for units with platform top

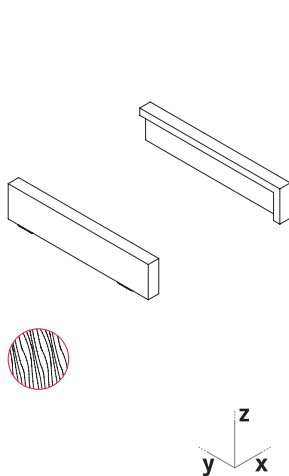

	x	y	z	codice code	note notes	finitura finish	colori colours	colori colours
dx rh	2	40	12	30.220		<b>T</b>		
sx lh	2	40	12	30.221		•	7035	A838
						•	ACE	999XA
						•	BIA	995XM
							FAG	989XR
						•	MTZ	994XS
						•	PAN	997XS
dx rh	2	50	12	30.222		•	A439	983XR
sx lh	2	50	12	30.223		•	ANT	984XA
							K101	BLACK
							3813	GREEN
							2293	BEIGE
							990XA	WHITE
							990XM	
dx rh	2	60	12	30.224				
sx lh	2	60	12	30.225				



Tamponamenti e finiture  
Covering and finishing

12.3

Finitura a T per elementi terminali con piano pedana  
End T shaped cover for units with platform top

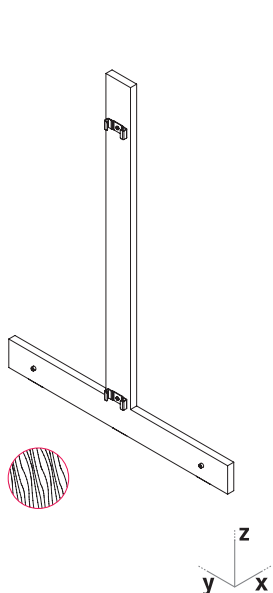

	x	y	z	codice code	note notes	finitura finish	colori colours	colori colours
	2	89	122	30.226		<b>T</b>		
	2	109	122	30.227		•	7035	A838
						•	ACE	999XA
						•	BIA	995XM
							FAG	989XR
						•	MTZ	994XS
						•	PAN	997XS
						•	A439	983XR
						•	ANT	984XA
							K101	BLACK
							3813	GREEN
							2293	BEIGE
							990XA	WHITE
							990XM	
	2	89	158	30.232				
	2	109	158	30.233				
	2	129	158	30.234				



Tamponamenti e finiture  
Covering and finishing

12.4

Finitura terminale per moduli di base con supporto testa tonda  
End wooden cover for units with round head support

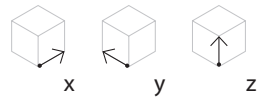
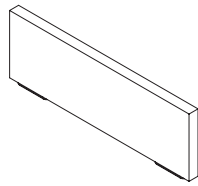

x	y	z	codice code	note notes	finitura finish	colori colours	colori colours
2	40	13	30.235		T		
2	50	13	30.236		•	7035	A838
2	60	13	30.237		•	ACE	999XA
					•	BIA	995XM
					•	FAG	989XR
					•	MTZ	994XS
					•	PAN	997XS
					•	A439	983XR
					•	ANT	984XA
						K101	BLACK
						3813	GREEN
						2293	BEIGE
						990XA	WHITE
						990XM	



Tamponamenti e finiture  
Covering and finishing

12.5

Finitura terminale a "T" per moduli di base con supporto testa tonda  
End T shaped cover for units with round head support

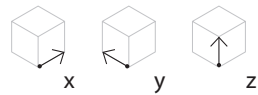
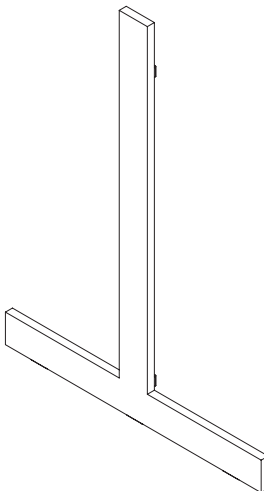

x	y	z	codice code	note notes	finitura finish	colori colours	colori colours
2	91	122	30.238		T		
2	111	122	30.239		•	7035	A838
2	131	122	30.240		•	ACE	999XA
					•	BIA	995XM
					•	FAG	989XR
					•	MTZ	994XS
					•	PAN	997XS
					•	A439	983XR
					•	ANT	984XA
2	91	140	30.241			K101	BLACK
2	111	140	30.242			3813	GREEN
2	131	140	30.243			2293	BEIGE
						990XA	WHITE
						990XM	
2	91	158	30.244				
2	111	158	30.245				
2	131	158	30.246				

Composizione pannelli  
Facing setting

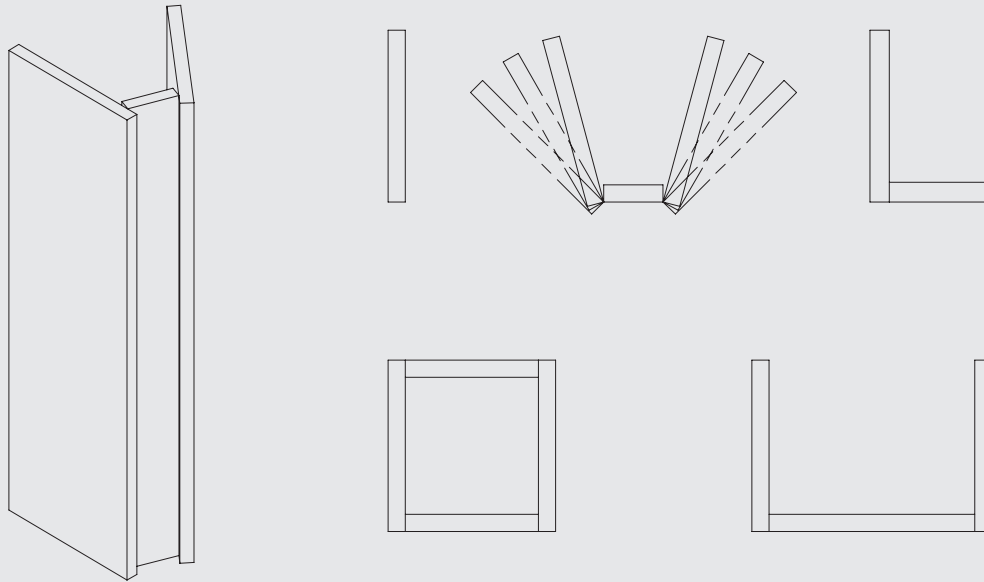

Tamponamenti e finiture  
Covering and finishing

12.6

Pannello in legno nobilitato con un filo finito  
Facing with 1 melamine finish

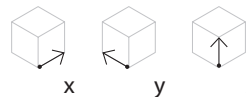

x	y	z	codice code	note notes
2	--	--	30.186	
2,5	--	--	30.188	

finitura finish	colori colours
T	7035
•	ACE
•	BIA
•	FAG
•	MTZ
•	PAN
•	A439
•	ANT
	K101
	3813
	2293
	990XA
	990XM
	A838
	999XA
	995XM
	989XR
	994XS
	997XS
	983XR
	984XA
	BLACK
	GREEN
	BEIGE
	WHITE

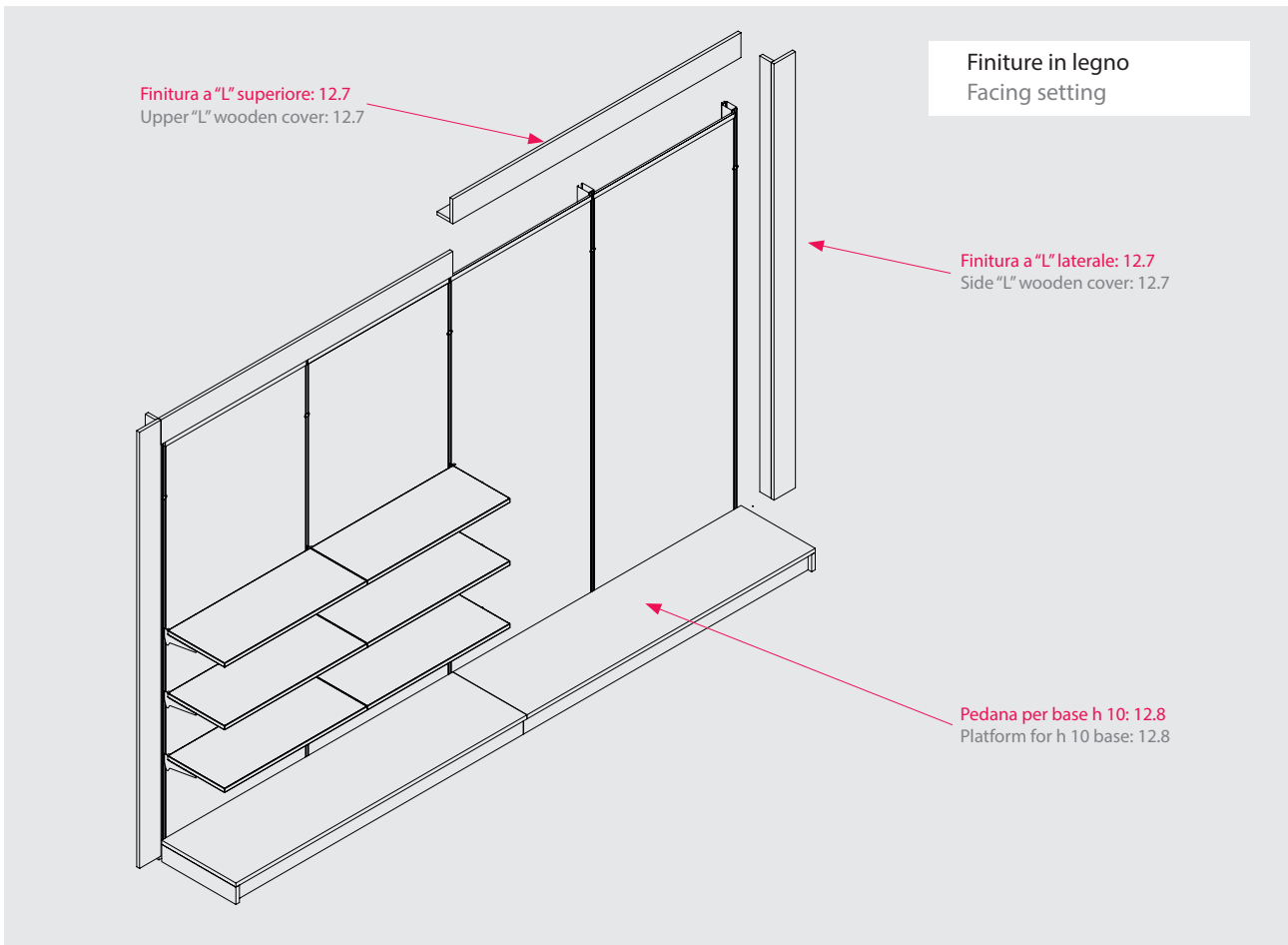

**Tamponamenti e finiture**  
Covering and finishing

**12.7** Finitura "L" per cornice per elementi a parete  
L wooden cover for wall bays

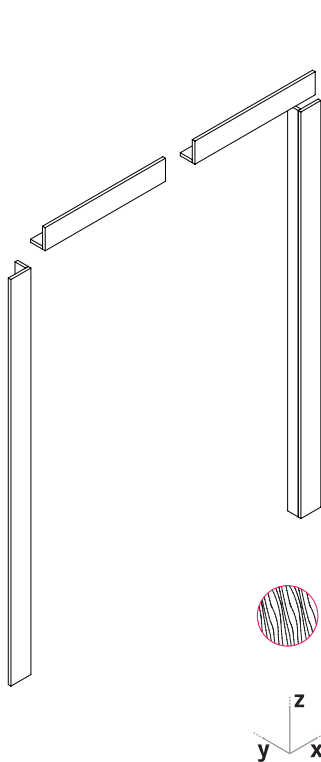

	x	y	z	codice code	note notes
sx/dx	15	--	205		30.495
sx/dx	15	--	234		30.496
sx/dx	15	--	252		30.497

Fissaggio/Fixing: - Nr.3 FE.251

**Traverso superiore per elementi a parete**  
Top frame for wall bays

	x	y	z	codice code	note notes
dx rh	200	--	15		30.498

Fissaggio/Fixing: - Nr.3 FE.251

finitura finish	colori colours
<b>T</b>	
•	7035
•	ACE
•	BIA
•	FAG
•	MTZ
•	PAN
•	A439
•	ANT
	K101
	3813
	2293
	990XA
	990XM
	A838
	999XA
	995XM
	989XR
	994XS
	997XS
	983XR
	984XA
	BLACK
	GREEN
	BEIGE
	WHITE

Prevedere come terminali l'utilizzo di piantane tubolari.  
Tubular upright to be used on wall bay ends





Tamponamenti e finiture  
Covering and finishing

12.8

Pedane per elementi a parete con base h 10 per finitura a cornice  
Wooden platform for wall bays with h 10 base and wooden frame

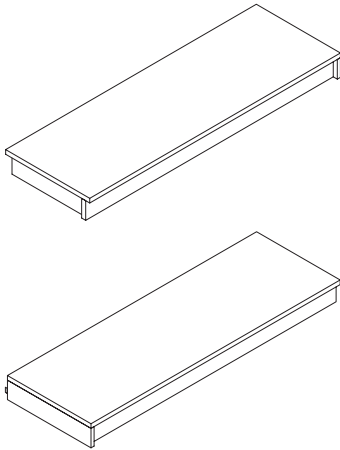

	x	y	z	codice code	note notes
dx rh	52	13	30.372	per modulo da 3 mt	
sx lh	52	13	30.373	per modulo da 3 mt	
dx rh	52	13	30.374	per modulo da 4 mt	
sx lh	52	13	30.375	per modulo da 4 mt	
dx rh	52	13	30.376	per modulo da 5 mt	
sx lh	52	13	30.377	per modulo da 5 mt	

finitura finish	colori colours
T	
•	7035
•	ACE
•	BIA
	FAG
•	MTZ
•	PAN
•	A439
•	ANT
	K101
	3813
	2293
	990XA
	990XM
	A838
	999XA
	995XM
	989XR
	994XS
	997XS
	983XR
	984XA
	BLACK
	GREEN
	BEIGE
	WHITE



Tamponamenti e finiture  
Covering and finishing

12.9

Pedana per elementi a gondola con base h 10 e zoccolo per spalla doppia e top  
Wooden platform for gondola bays h 10 footbase and wooden shoulder and platform

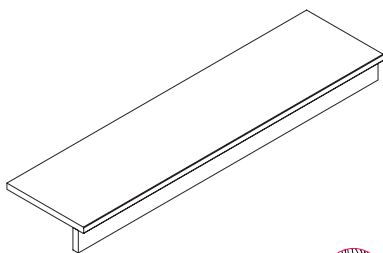

	x	y	z	codice code	note notes
	150	35,5	11,5	30.379	per modulo da 3 mt
	200	35,5	11,5	30.380	per modulo da 4 mt
	250	35,5	11,5	30.381	per modulo da 5 mt

finitura finish	colori colours
T	
•	7035
•	ACE
•	BIA
	FAG
•	MTZ
•	PAN
•	A439
•	ANT
	K101
	3813
	2293
	990XA
	990XM
	A838
	999XA
	995XM
	989XR
	994XS
	997XS
	983XR
	984XA
	BLACK
	GREEN
	BEIGE
	WHITE

Tamponamenti e finiture  
Covering and finishing

12.10

Top in legno per elementi a gondola con spalla doppia e pedana  
Wooden top for gondola bay with shoulder and platform

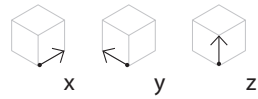
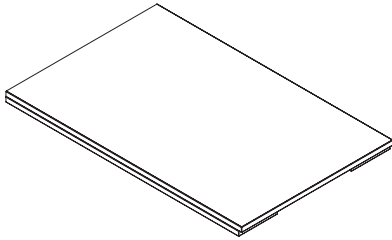

x	y	z	codice code	note notes
155	79	5	30.382	per modulo da 3 mt
205	79	5	30.383	per modulo da 4 mt
255	79	5	30.384	per modulo da 5 mt

finitura finish	colori colours
T	
•	7035
•	ACE
•	BIA
•	FAG
•	MTZ
•	PAN
•	A439
•	ANT
	K101
	3813
	2293
	990XA
	990XM
	A838
	999XA
	995XM
	989XR
	994XS
	997XS
	983XR
	984XA
	BLACK
	GREEN
	BEIGE
	WHITE

Tamponamenti e finiture  
Covering and finishing

12.11

Spalla doppia in legno di testata per gondola con top e pedana  
Wooden shoulder for gondola with wooden top and platform

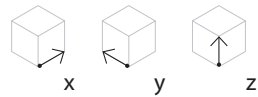
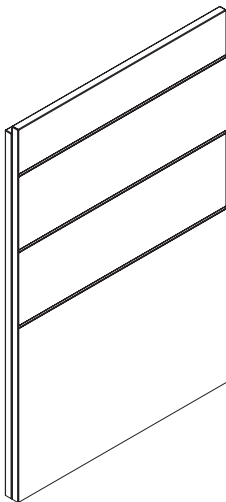

x	y	z	codice code	note notes
79	5	123	30.385	

Da usare con piantana da 7,2 cm e base h 10 x 30  
To be used with 7,2 upright and footbase h 10 x 30

finitura finish	colori colours
T	
•	7035
•	ACE
•	BIA
•	FAG
•	MTZ
•	PAN
•	A439
•	ANT
	K101
	3813
	2293
	990XA
	990XM
	A838
	999XA
	995XM
	989XR
	994XS
	997XS
	983XR
	984XA
	BLACK
	GREEN
	BEIGE
	WHITE



12.12

Finitura terminale a L per elementi a parete con piano pedana  
End L shaped cover for wall units with wooden footbase

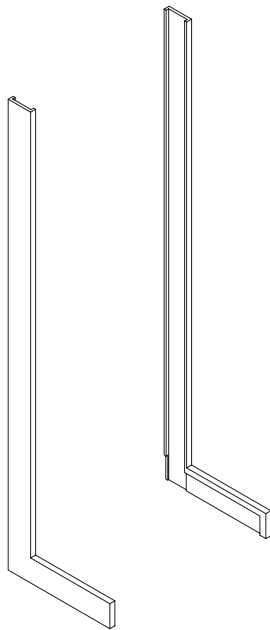

x	y	z	codice code	note notes
2,5	41	187	30.386	per base h 10 x 30
2,5	51	187	30.386	per base h 10 x 40
2,5	61	187	30.386	per base h 10 x 50
2,5	41	205	30.386	per base h 10 x 30
2,5	51	205	30.386	per base h 10 x 40
2,5	61	205	30.386	per base h 10 x 50
2,5	41	223	30.386	per base h 10 x 30
2,5	51	223	30.386	per base h 10 x 40
2,5	61	223	30.386	per base h 10 x 50
2,5	41	234	30.386	per base h 10 x 30
2,5	51	234	30.386	per base h 10 x 40
2,5	61	234	30.386	per base h 10 x 50
2,5	41	252	30.386	per base h 10 x 30
2,5	51	252	30.386	per base h 10 x 40
2,5	61	252	30.386	per base h 10 x 50

finitura finish	colori colours
T	
•	7035
•	ACE
•	BIA
•	FAG
•	MTZ
•	PAN
•	A439
•	ANT
	K101
	3813
	2293
	990XA
	990XM
	A838
	999XA
	995XM
	989XR
	994XS
	997XS
	983XR
	984XA
	BLACK
	GREEN
	BEIGE
	WHITE

Da usare con piantana  
terminale tubolare da 9 cm e base  
bassa h 10  
To be used with end tubular  
upright 9 cm and h 10 base

30.386  
Specificare altezza piantana e  
profondità base  
Specify upright height and base  
depth

Tamponamenti e finiture  
Covering and finishing

12.13

Finitura terminale a T per elementi a gondola con piano pedana  
End T shaped cover for gondola units with wooden footbase

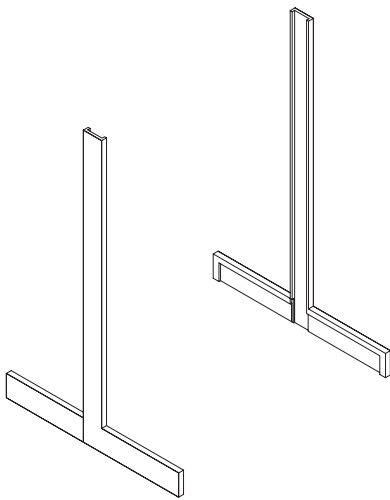

	x	y	z	codice code	note notes
	2,5	68,5	140	30.387	base 30
	2,5	88,5	140	30.387	base 40
	2,5		140	30.387	base 50
	2,5	68,5	158	30.387	base 30
	2,5	88,5	158	30.387	base 40
	2,5		158	30.387	base 50

finitura finish	colori colours
<b>T</b>	
•	7035
•	ACE
•	BIA
•	FAG
•	MTZ
•	PAN
•	A439
•	ANT
	K101
	3813
	2293
	990XA
	990XM
	A838
	999XA
	995XM
	989XR
	994XS
	997XS
	983XR
	984XA
	BLACK
	GREEN
	BEIGE
	WHITE

Da usare con piantana  
tubolare da 7,2 cm e  
base bassa h 10  
To be used with tubular  
upright 7,2 cm and h 10 base

30.387  
Specificare altezza piantana e  
profondità base  
Specify upright height and base  
depth

Tamponamenti e finiture  
Covering and finishing

12.14

Coperchio di chiusura in legno per finiture terminali  
End wooden top cover for end shaped

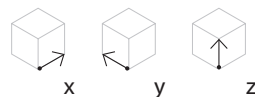
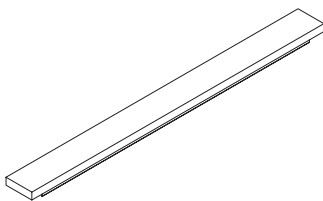

	x	y	z	codice code	note notes
Terminale end	53	*	2,5	30.398	**
	78	*	2,5	30.398	**
	103	*	2,5	30.398	**
Consecutivo Consecutive	50	*	2,5	30.388	**
	75	*	2,5	30.388	**
	100	*	2,5	30.388	**
Testata Head	54	*	2,5	30.399	**
	79	*	2,5	30.399	**
	104	*	2,5	30.399	**

finitura finish	colori colours
<b>T</b>	
•	7035
•	ACE
•	BIA
•	FAG
•	MTZ
•	PAN
•	A439
•	ANT
	K101
	3813
	2293
	990XA
	990XM
	A838
	999XA
	995XM
	989XR
	994XS
	997XS
	983XR
	984XA
	BLACK
	GREEN
	BEIGE
	WHITE

\* Specificare misura piantana  
(tub. da 9 o tub. da 7,2)  
\* Specify upright measure  
(tub. 9 or tub. 7,2)

\*\*Specificare passo elemento  
Specify unit measure



Tamponamenti e finiture  
Covering and finishing

12.15

Piano pedana con zoccolo in legno  
*Wooden platform with plinth*

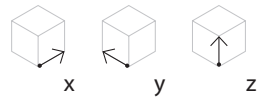
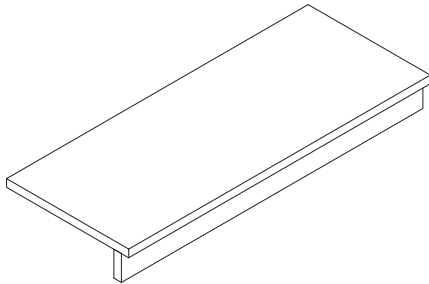

x	y	z	codice code	note notes
50	30	11	30.391	per base h 10 x 30
75	30	11	30.390	per base h 10 x 30
100	30	11	30.389	per base h 10 x 30
50	40	11	30.394	per base h 10 x 40
75	40	11	30.393	per base h 10 x 40
100	40	11	30.392	per base h 10 x 40
50	50	11	30.397	per base h 10 x 50
75	50	11	30.396	per base h 10 x 50
100	50	11	30.395	per base h 10 x 50



finitura finish	colori colours
T	
•	7035
•	ACE
•	BIA
•	FAG
•	MTZ
•	PAN
•	A439
•	ANT
	K101
	3813
	2293
	990XA
	990XM
	A838
	999XA
	995XM
	989XR
	994XS
	997XS
	983XR
	984XA
	BLACK
	GREEN
	BEIGE
	WHITE

**note**  
*notes*

**note**  
*notes*

Promozionali, pedane e cesti  
*Promotional displays, baskets  
and platforms*

# 13



Promozionali in filo, promozionali in legno, cesti in filo, pedane espositive e di servizio.

*Wire promotional displays, wooden promotional displays, wire baskets, pallet platforms and projecting counters.*





Composizione dei promozionali  
Promotional displays setting

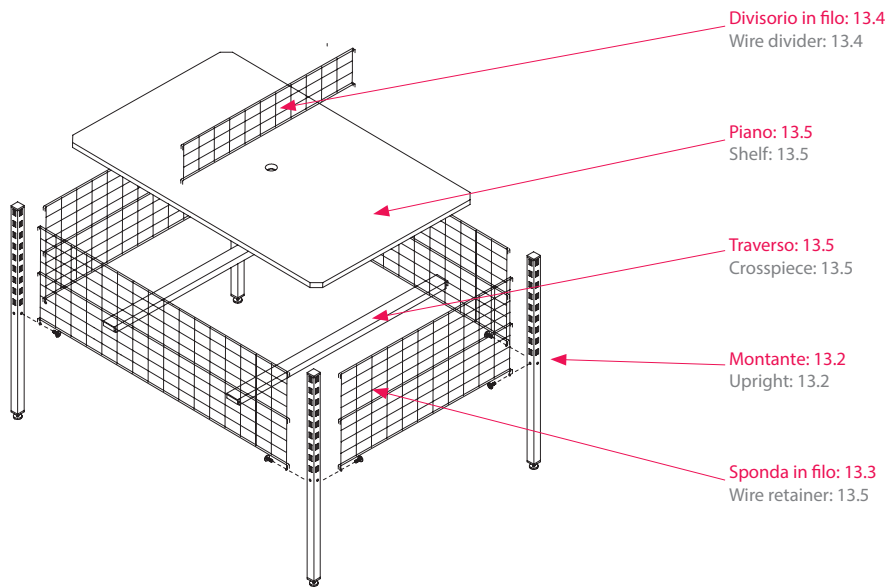

Promozionale 80 x 80 cm  
Promotional display 80 x 80 cm

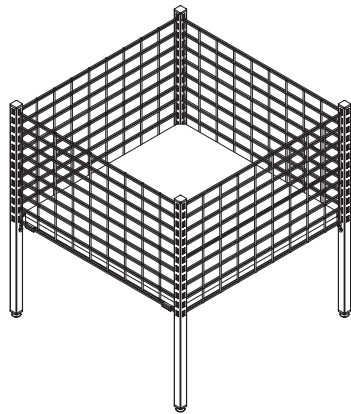

Promozionale 120 x 80 cm  
Promotional display 120 x 80 cm

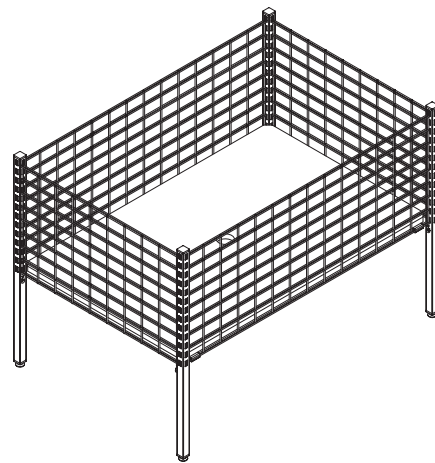

Dimensioni delle possibili composizioni  
Measurements of possible settings

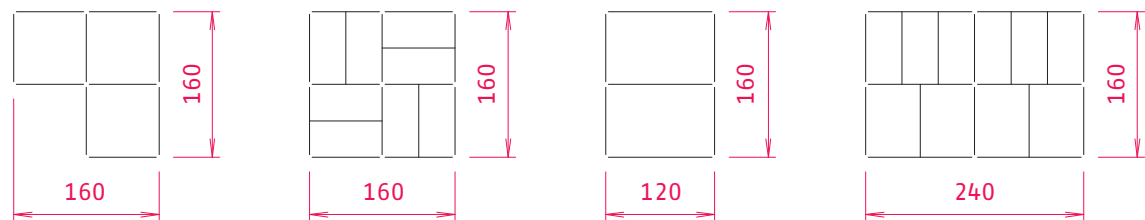



Promozionali  
Promotional  
Displays

13.1

Promozionale in filo cromato con sponde h 44 | piano in legno  
Promotional display unit with wire retainers h 44 | wooden shelf

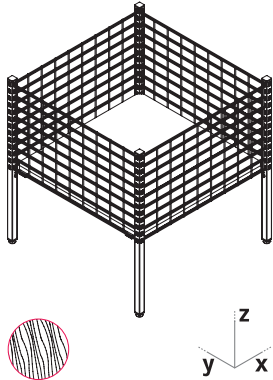

x	y	z	codice code	note notes
80	80	85	27.-30	
120	80	85	27.-31	

finitura finish	colori colours
C	
	2004
	6018
	6027
•	7035
	AMA
	ANT
	AZZ
	1001
•	BIA
	BLU
	GIA
	MAR
•	MTZ
•	PAN
	RO3
	BIMCL
	NRMCL
	OXI
	---



Promozionali  
Promotional  
Displays

13.2

Montante per promozionali con tappo e regolatore  
Promotional upright with cap and adjuster

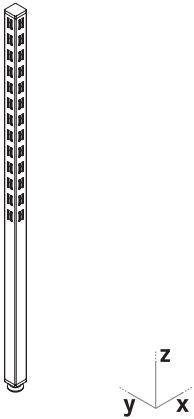

x	y	z	codice code	finitura e colore finish & finish & colour	note notes
3	3	85	10.162	C	



Promozionali  
Promotional  
Displays

13.3

Sponda in filo per promozionale  
Wire retainer for promotional display unit

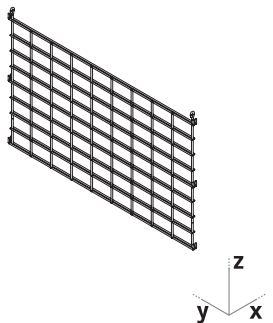

x	y	z	codice code	finitura e colore finish & finish & colour	note notes
--	80	44	34.303	C	
--	120	44	34.302	C	



Promozionali  
Promotional  
Displays

13.4

Divisorio in filo per promozionale  
Wire divider for promotional display unit

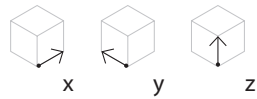
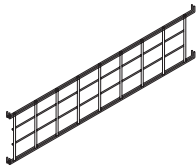

x y z

codice  
code

finitura e  
colore  
finish &  
colour

note  
notes

76,8	--	17	34.304	C	
------	----	----	--------	---	--



Promozionali  
Promotional  
Displays

13.5

Piano per promozionale  
Promotional shelf

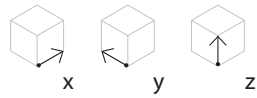
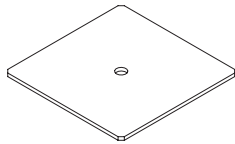

x y z

codice  
code

note  
notes

finitura  
finish

colori  
colours

74,5	74,5	2	30.285	
114,5	74,5	2	30.286	
60	80	2	17.990	

T	
•	7035
•	ACE
•	BIA
•	FAG
•	MTZ
•	PAN
•	A439
•	ANT
	K101
	3813
	2293
	990XA
	990XM
	A838
	999XA
	995XM
	989XR
	994XS
	997XS
	983XR
	984XA
	BLACK
	GREEN
	BEIGE
	WHITE

Traverso per piano promozionale  
Crosspiece for promotional shelf

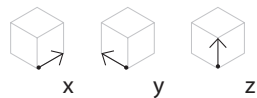
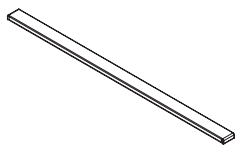

x y z

codice  
code

note  
notes

finitura  
finish

colori  
colours

--	76,5	--	99.-22	
----	------	----	--------	--

P	
	2004
	6018
	6027
•	7035
	AMA
	ANT
	AZZ
	1001
•	BIA
	BLU
	GIA
	MAR
	MTZ
•	PAN
	RO3
	BIMCL
	NRMCL
	OXI



Promozionali  
Promotional  
Displays

13.6

Promozionale in filo cromato con sponde h 20 | piano in legno  
Promotional display unit with wire retainers h 20 | wooden shelf

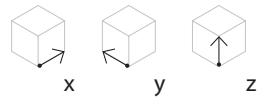
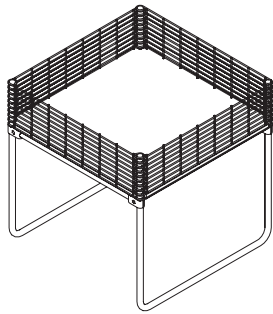

x	y	z	codice code	note notes
75	75	75	27.-02	

finitura finish	colori colours
C	
	2004
	6018
	6027
•	7035
	AMA
	ANT
	AZZ
	1001
•	BIA
	BLU
	GIA
	MAR
•	MTZ
•	PAN
	RO3
	BIMCL
	NRMCL
	OXI
	---



Promozionali  
Promotional  
Displays

13.7

Promozionale in filo cromato con sponde h 40 | piano in legno  
Promotional display unit with wire retainers h 40 | wooden shelf

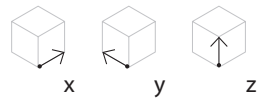
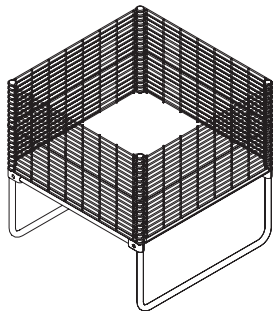

x	y	z	codice code	note notes
75	75	75	27.-03	

finitura finish	colori colours
C	
	2004
	6018
	6027
•	7035
	AMA
	ANT
	AZZ
	1001
•	BIA
	BLU
	GIA
	MAR
•	MTZ
•	PAN
	RO3
	BIMCL
	NRMCL
	OXI
	---



Promozionali  
Promotional  
Displays

13.8

Promozionale in filo con sponda h 50 | piano in legno  
Promotional display unit with wire retainers h 50 | wooden shelf

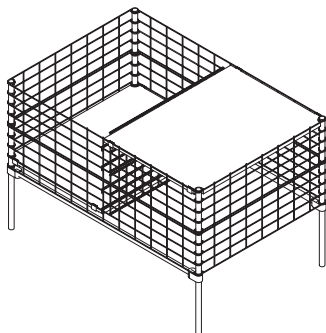

x	y	z	codice code	finitura finish	note notes
120	80	80	27.-53	C	

piano legno: 13.5  
wooden shelf: 13.5

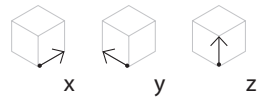
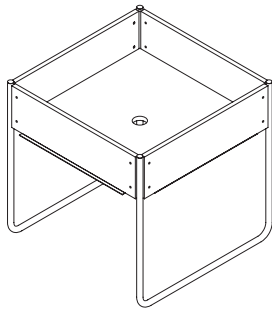

x	y	z	codice code	note notes
75	75	75	27.-41	

finitura finish		colori colours
T	V	
		7035
		ACE
•		BIA
		FAG
	•	MTZ
		PAN
•		A439
	•	ANT
		K101
		3813
		2293
		990XA
		990XM
		984XA
		999XA
		995XM
		989XR
		994XS
		997XS
		983XR
		984XA
		BLACK
		GREEN
		BEIGE
		WHITE

## Composizione cesti Baskets setting

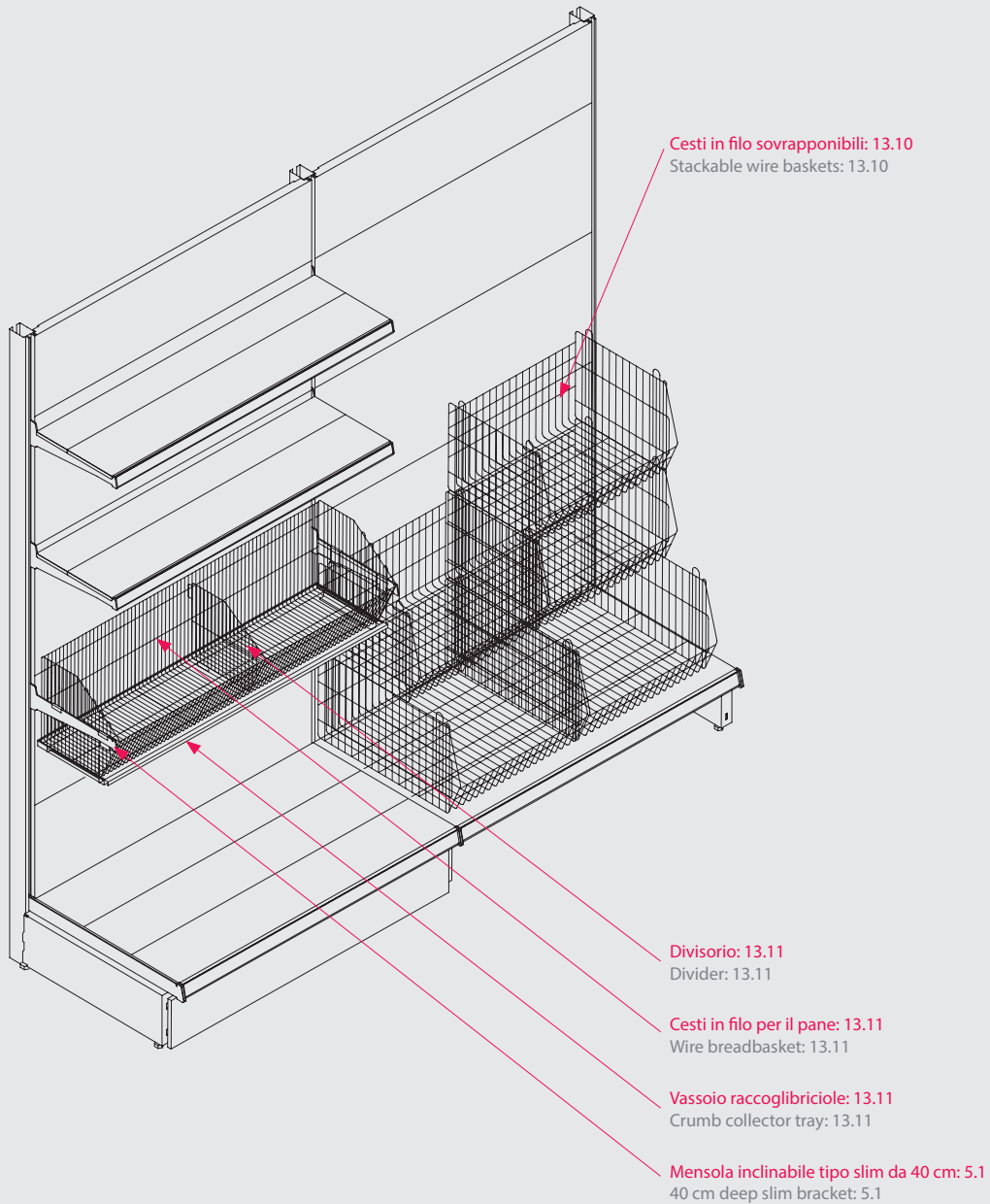



Cesti  
Baskets

13.10

Cesti in filo sovrapponibili  
Stackable wire basket

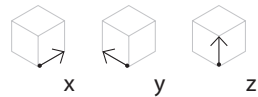

	x	y	z	codice code	finitura e colore finish & colour	note notes
	48	40	25	25.-01	C	
	48	50	25	25.-02	C	
	48	60	25	25.-03	C	

Divisori per cesti in filo sovrapponibili  
Wire divider for stackable wire basket

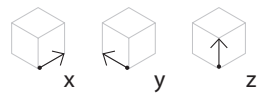
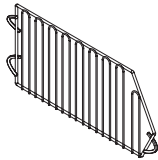

	x	y	z	codice code	finitura e colore finish & colour	note notes
--	40	25	25.-10	C		
--	50	25	25.-11	C		
--	60	25	25.-12	C		



Cesti  
Baskets

13.11

Cesto in filo per mensola da 40 / per il pane  
Wire breadbasket for 40 cm deep bracket

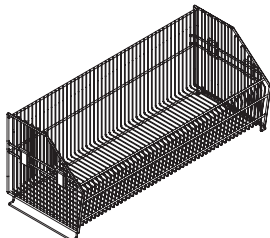

	x	y	z	codice code	finitura e colore finish & colour	note notes
	100	40	42	25.-58	C	

Divisorio per cesto in filo per mensola da 40  
Divider for wire breadbasket



	x	y	z	codice code	finitura e colore finish & colour	note notes
--	38	40	25.-59	C		

Vassoio raccoglibriciole  
Crumb collector tray for wire breadbasket

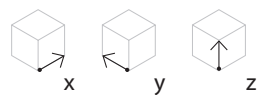
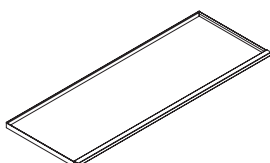

	x	y	z	codice code	note notes	finitura finish	colori colours
	95	40	--	25.-60		P	



•		7035
•		BIA
•		PAN





Pedane  
Platforms

13.12

Pedana pallet in tubo senza piano  
Pallet platform without top

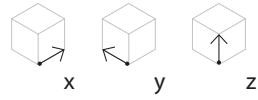
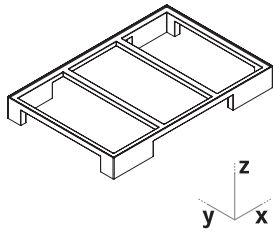

x	y	z	codice code	note notes
120	80	14	30.261	

finitura finish	colori colours
V	2004
	6018
	6027
	• 7035
	AMA
	• ANT
	AZZ
	1001
	• BIA
	BLU
	GIA
	MAR
	• MTZ
	• PAN
	RO3
	BIMCL
	NRMCL
	• OXI

Piano per pedana pallet con supporto in legno  
Platform top for pallets

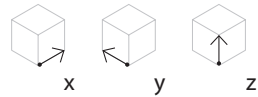
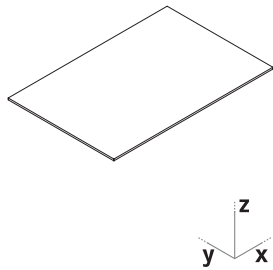

x	y	z	codice code	note notes
117	77	--	30.205	

finitura finish	colori colours
N	2004
P	6018
	6027
	• 7035
	AMA
	ANT
	AZZ
	1001
	• BIA
	BLU
	GIA
	MAR
	MTZ
	• PAN
	RO3
	BIMCL
	NRMCL
	OXI
•	---

note  
notes

**note**  
notes

# Banchi *Desks*

# 14

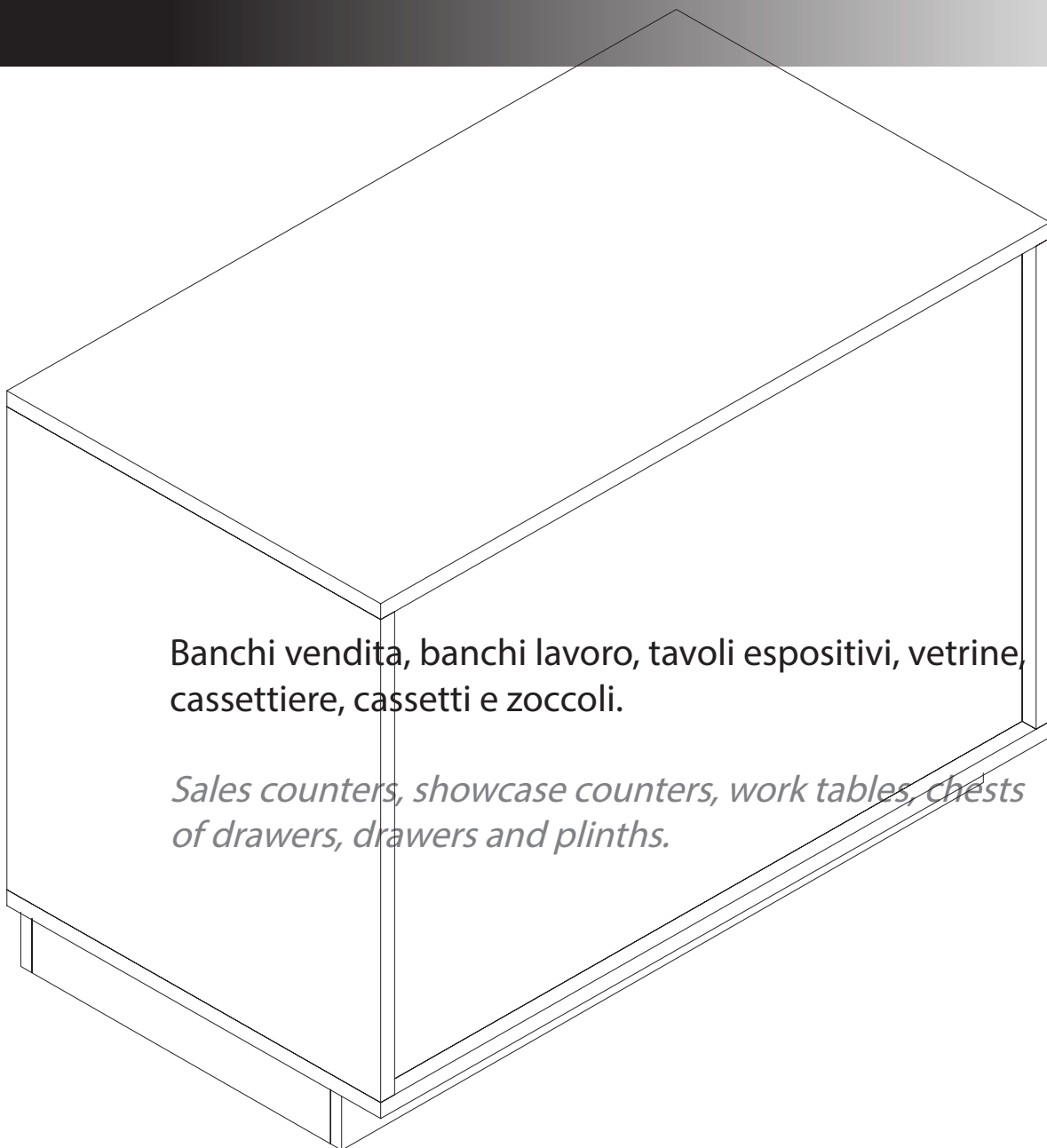



## Composizione banchi legno con angolo chiuso e aperto a 45° Counters composition with closed and open corner at 45°

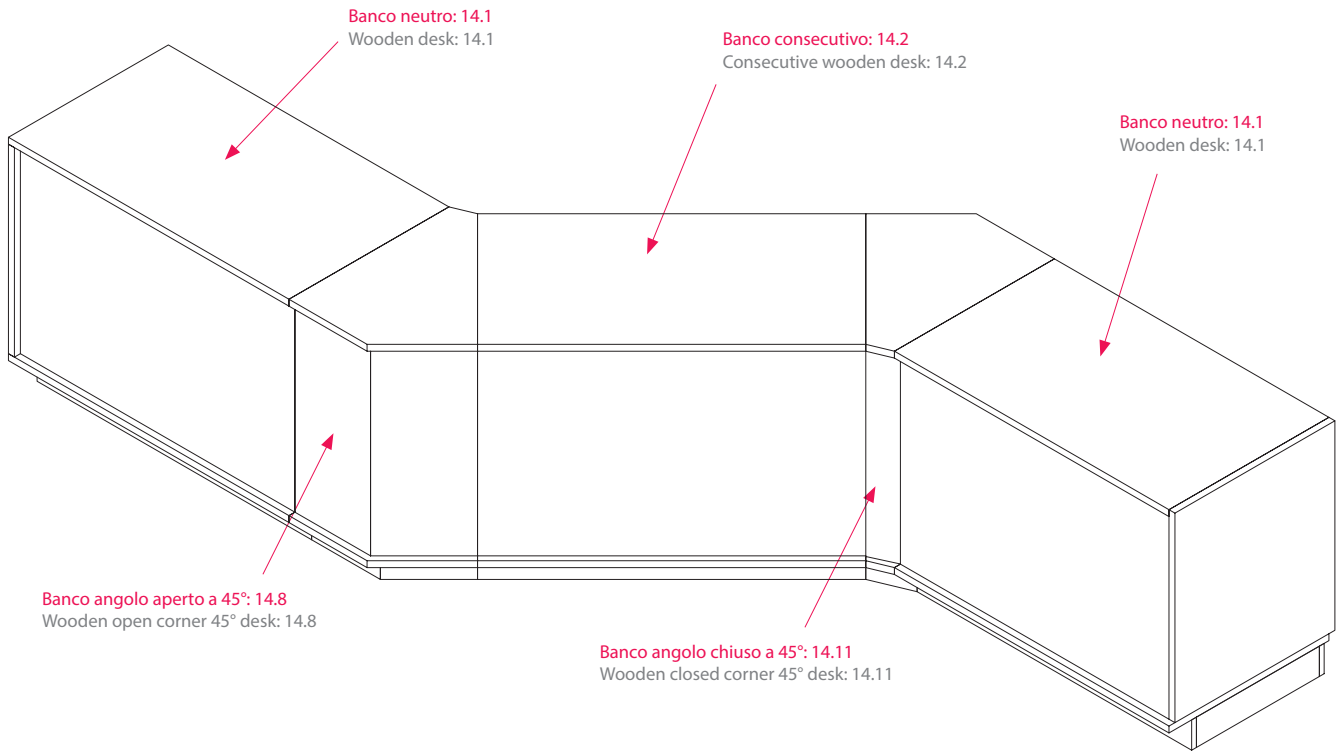

## Composizione banchi legno con angolo chiuso e aperto a 90° Counters composition with closed and open corner at 90°

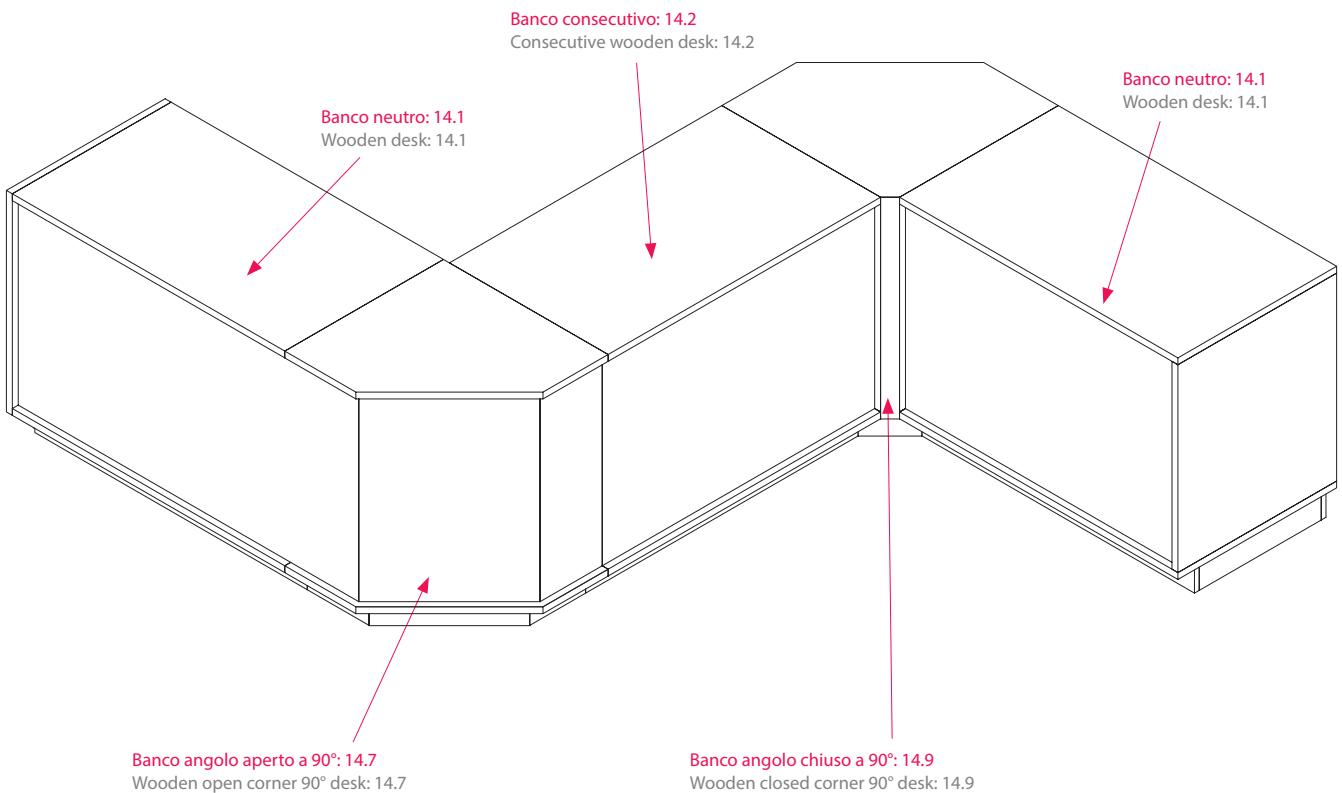

## Composizione banchi vetrina con cassetto estraibile e ripiani interni fissi Counters composition with closed and open corner at 45°

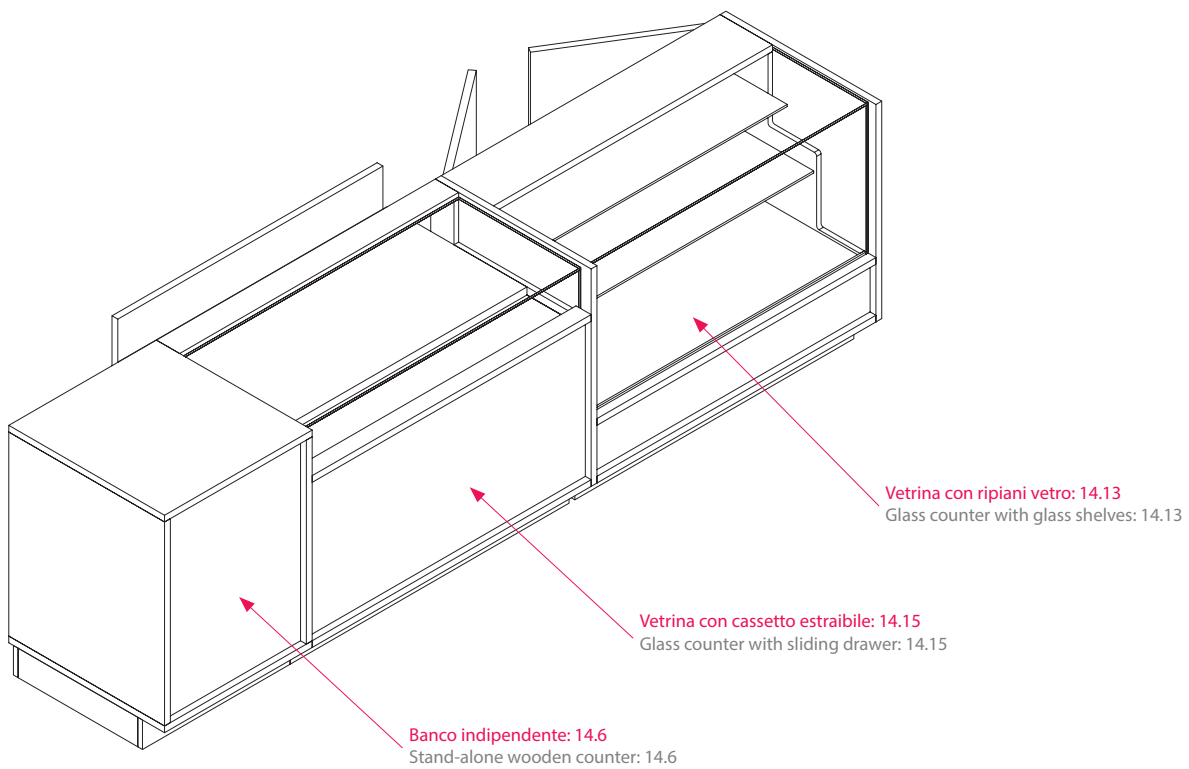

## Composizione banchi vetrina con cassetti estraibili e gradoni, cassettone estraibile Counters composition with closed and open corner at 90°

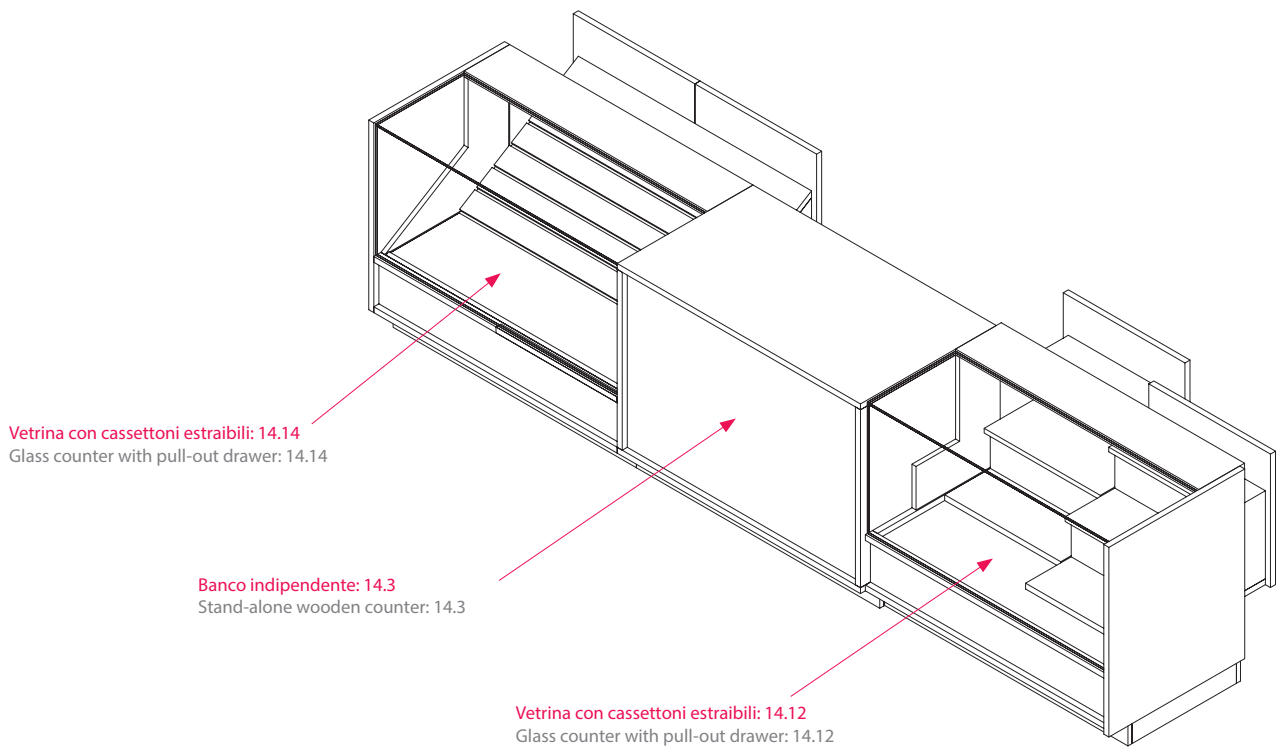

# PERSONALIZZAZIONE Customization

Con il configuratore fornito in dotazione è possibile generare un codice per banchi e vetrine personalizzate specificando la finitura di ogni componente

With the configurator supplied you can generate code for counters and display  
Individual specifying the finish of each component

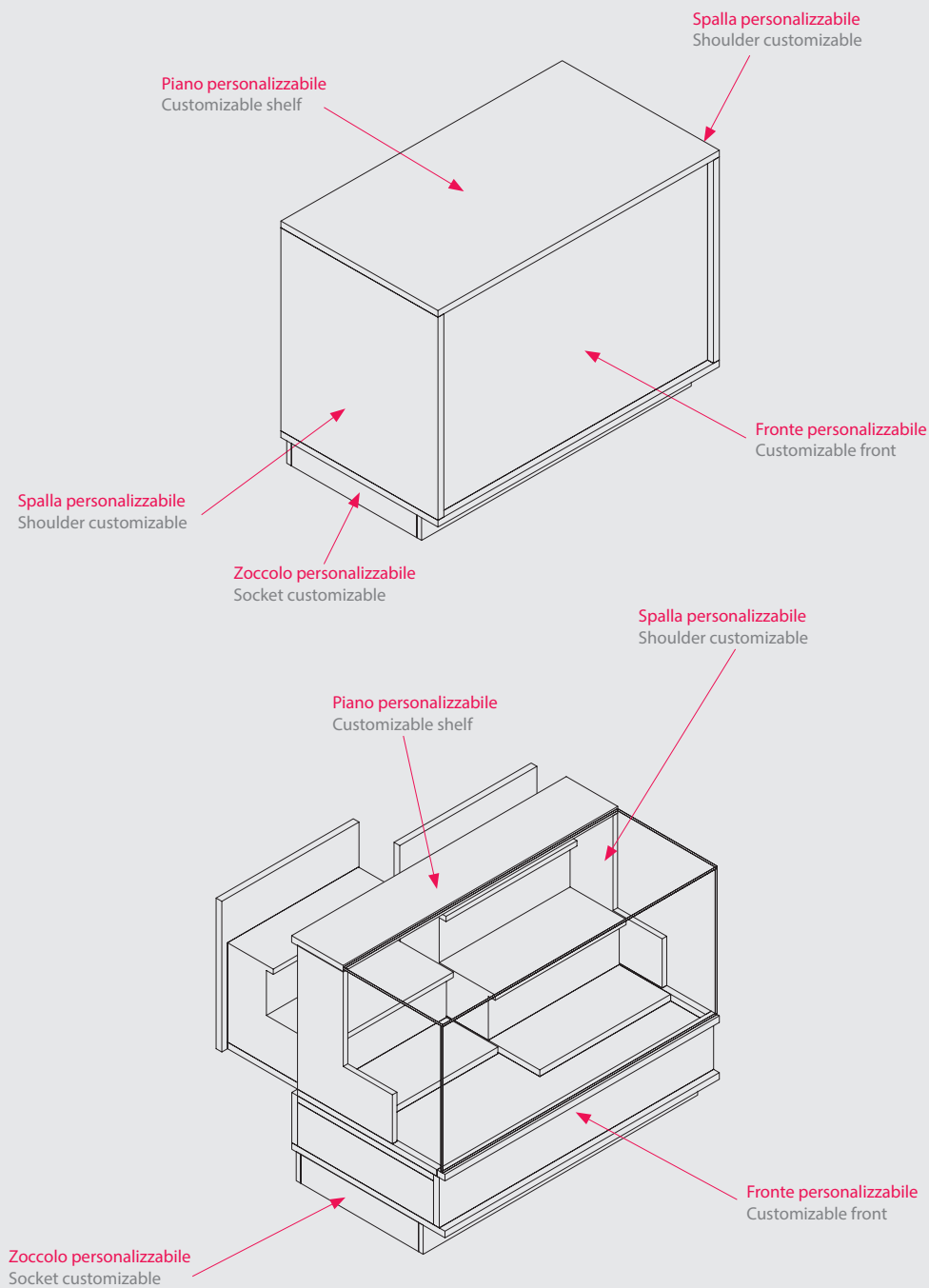



**Banchi Desks** **14.1** Banco neutro in legno  
Wooden desk

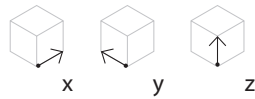
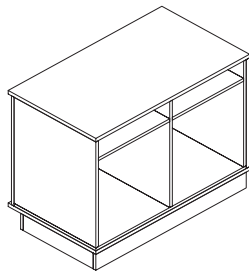
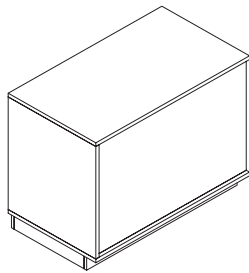

	67	92	codice code	29.261
--	----	----	-------------	--------

finitura finish	colori colours
T	
•	7035
•	ACE
•	BIA
•	FAG
•	MTZ
•	PAN
•	A439
•	ANT
	K101
	3813
	2293
	990XA
	990XM
	A838
	999XA
	995XM
	989XR
	994XS
	997XS
	983XR
	984XA
	BLACK
	GREEN
	BEIGE
	WHITE

**Banchi Desks** **14.2** Banco neutro in legno consecutivo  
Consecutive wooden desk

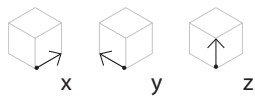
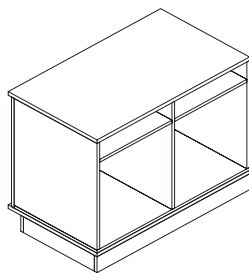
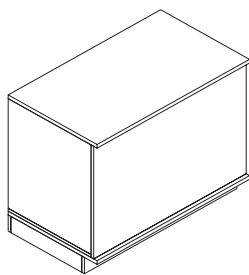

115	67	92	codice code	29.261
-----	----	----	-------------	--------

finitura finish	colori colours
T	
•	7035
•	ACE
•	BIA
•	FAG
•	MTZ
•	PAN
•	A439
•	ANT
	K101
	3813
	2293
	990XA
	990XM
	A838
	999XA
	995XM
	989XR
	994XS
	997XS
	983XR
	984XA
	BLACK
	GREEN
	BEIGE
	WHITE



Banchi  
Desks

14.3

Banco indipendente in legno  
Stand-alone wooden counter

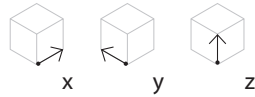
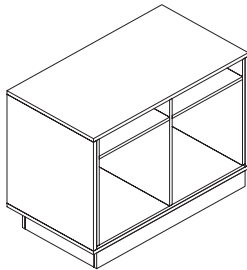
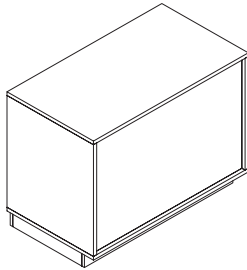

120	67	92	codice code	29.261
-----	----	----	----------------	--------

finitura finish	colori colours
T	
•	7035
•	ACE
•	BIA
•	FAG
•	MTZ
•	PAN
•	A439
•	ANT
	K101
	3813
	2293
	990XA
	990XM
	A838
	999XA
	995XM
	989XR
	994XS
	997XS
	983XR
	984XA
	BLACK
	GREEN
	BEIGE
	WHITE



Banchi  
Desks

14.4

Banco neutro in legno  
Wooden desk

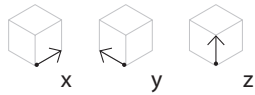
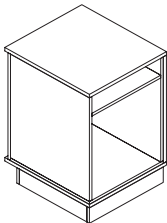
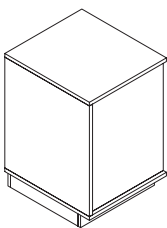

61	67	92	codice code	29.260
----	----	----	----------------	--------

finitura finish	colori colours
T	
•	7035
•	ACE
•	BIA
•	FAG
•	MTZ
•	PAN
•	A439
•	ANT
	K101
	3813
	2293
	990XA
	990XM
	A838
	999XA
	995XM
	989XR
	994XS
	997XS
	983XR
	984XA
	BLACK
	GREEN
	BEIGE
	WHITE

**Banchi Desks** **14.5** **Banco neutro consecutivo in legno**  
**Consecutive wooden desk**

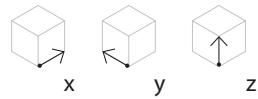
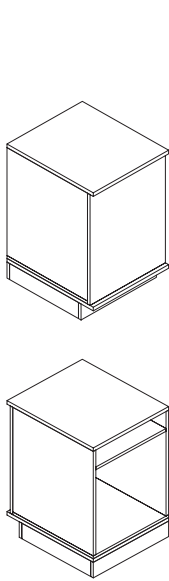

58,5	67	92	codice code	29.260
------	----	----	-------------	--------



finitura finish	colori colours
T	
•	7035
•	ACE
•	BIA
	FAG
•	MTZ
•	PAN
•	A439
•	ANT
	K101
	3813
	2293
	990XA
	990XM
	A838
	999XA
	995XM
	989XR
	994XS
	997XS
	983XR
	984XA
	BLACK
	GREEN
	BEIGE
	WHITE

**Banchi Desks** **14.6** **Banco indipendente in legno**  
**Stand-alone wooden counter**

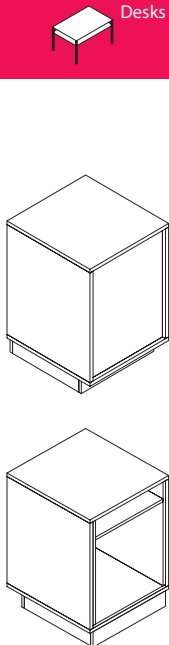

58,5	67	92	codice code	29.260
------	----	----	-------------	--------



finitura finish	colori colours
T	
•	7035
•	ACE
•	BIA
	FAG
•	MTZ
•	PAN
•	A439
•	ANT
	K101
	3813
	2293
	990XA
	990XM
	A838
	999XA
	995XM
	989XR
	994XS
	997XS
	983XR
	984XA
	BLACK
	GREEN
	BEIGE
	WHITE



Banchi  
Desks

14.7

Banco in legno angolo aperto a 90°  
Wooden open corner 90° desk

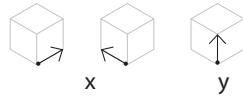

x

y

z

codice  
code

67/31,5

92

29.265

finitura  
finish

colori  
colours

T		
•		7035
•		ACE
•		BIA
•		FAG
•		MTZ
•		PAN
•		A439
•		ANT
		K101
		3813
		2293
		990XA
		990XM
		A838
		999XA
		995XM
		989XR
		994XS
		997XS
		983XR
		984XA
		BLACK
		GREEN
		BEIGE
		WHITE

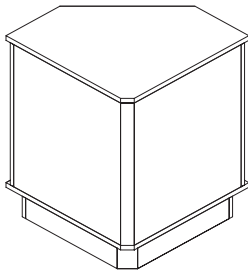
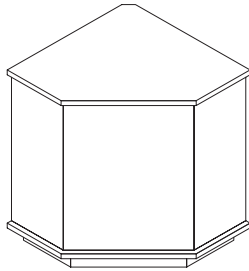

Banchi  
Desks

14.8

Banco in legno angolo aperto a 45°  
Wooden open corner 45° desk

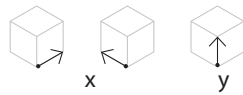

x

y

z

codice  
code

67/33

67/33

92

29.264

finitura  
finish

colori  
colours

T		
•		7035
•		ACE
•		BIA
•		FAG
•		MTZ
•		PAN
•		A439
•		ANT
		K101
		3813
		2293
		990XA
		990XM
		A838
		999XA
		995XM
		989XR
		994XS
		997XS
		983XR
		984XA
		BLACK
		GREEN
		BEIGE
		WHITE

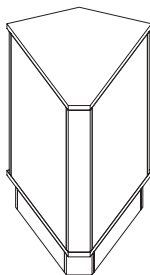
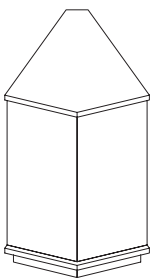



Banchi  
Desks

14.9

Banco in legno angolo chiuso a 90°  
Wooden closed corner 90° desk

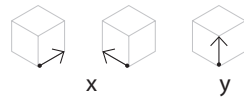
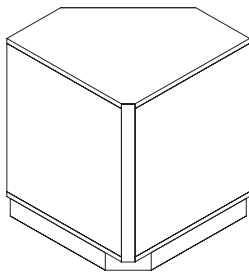
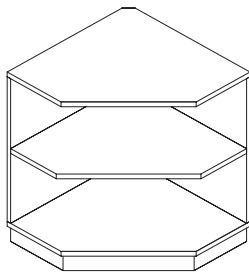

67/31,5

92

codice  
code  
29.263

finitura  
finish

colori  
colours

T		
•		7035
•		ACE
•		BIA
•		FAG
•		MTZ
•		PAN
•		A439
•		ANT
		K101
		3813
		2293
		990XA
		990XM
		A838
		999XA
		995XM
		989XR
		994XS
		997XS
		983XR
		984XA
		BLACK
		GREEN
		BEIGE
		WHITE



Banchi  
Desks

14.10

Banco in legno angolo chiuso a 90° con anta e serratura  
Wooden closed corner 90° desk with shutter and lock

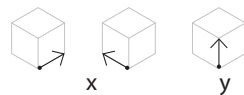
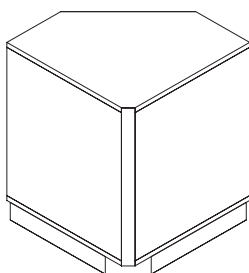
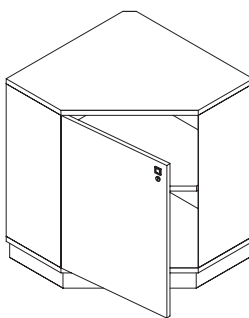

67/31,5

92

codice  
code  
29.270

finitura  
finish

colori  
colours

T		
•		7035
•		ACE
•		BIA
•		FAG
•		MTZ
•		PAN
•		A439
•		ANT
		K101
		3813
		2293
		990XA
		990XM
		A838
		999XA
		995XM
		989XR
		994XS
		997XS
		983XR
		984XA
		BLACK
		GREEN
		BEIGE
		WHITE



Banchi  
Desks

14.11

Banco in legno angolo chiuso a 45°  
Wooden closed corner 45° desk

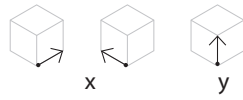

67/33

67/33

92

codice  
code  
29.262

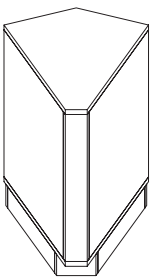
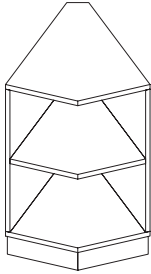

finitura finish	colori colours
T	7035
•	ACE
•	BIA
•	FAG
•	MTZ
•	PAN
•	A439
•	ANT
	K101
	3813
	2293
	990XA
	990XM
	A838
	999XA
	995XM
	989XR
	994XS
	997XS
	983XR
	984XA
	BLACK
	GREEN
	BEIGE
	WHITE



14.12

Vetrina con cassettoni estraibili  
Glass counter with pull-out drawer

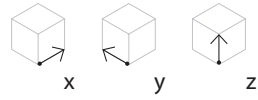
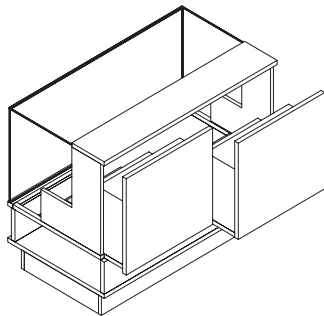
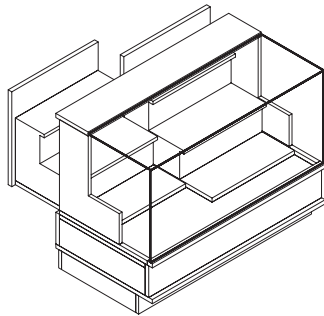

120	67	92	codice code	29.268
-----	----	----	----------------	--------

codice  
code

finitura  
finish

colori  
colours

finitura finish	colori colours
T	
•	7035
•	ACE
•	BIA
	FAG
•	MTZ
•	PAN
•	A439
•	ANT
	K101
	3813
	2293
	990XA
	990XM
	A838
	999XA
	995XM
	989XR
	994XS
	997XS
	983XR
	984XA
	BLACK
	GREEN
	BEIGE
	WHITE



14.13

Vetrina con ripiani in vetro  
Glass counter with glass shelves

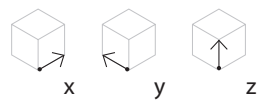
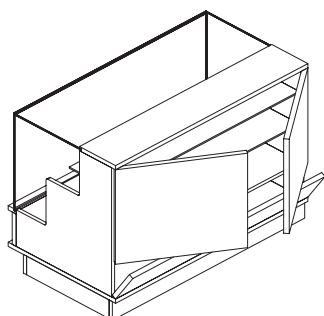
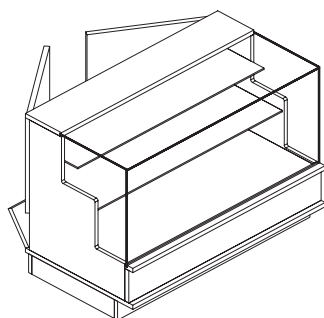

120	67	92	codice code	29.269
-----	----	----	----------------	--------

codice  
code

finitura  
finish

colori  
colours

finitura finish	colori colours
T	
•	7035
•	ACE
•	BIA
	FAG
•	MTZ
•	PAN
•	A439
•	ANT
	K101
	3813
	2293
	990XA
	990XM
	A838
	999XA
	995XM
	989XR
	994XS
	997XS
	983XR
	984XA
	BLACK
	GREEN
	BEIGE
	WHITE

Banchi  
Desks

14.14

Vetrina con cassettoni estraibili  
Glass counter with pull-out drawer

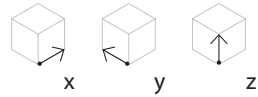
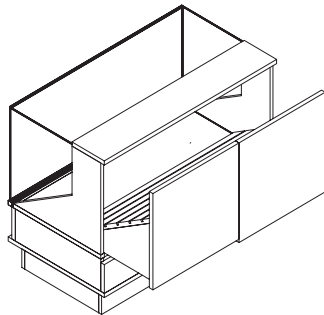
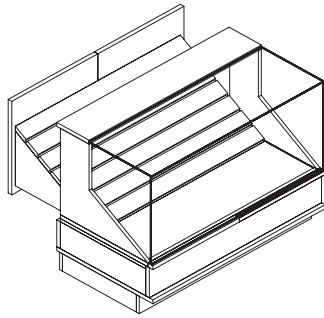

120	67	92	codice code	29.267
-----	----	----	----------------	--------

finitura finish	colori colours
T	
•	7035
•	ACE
•	BIA
	FAG
•	MTZ
•	PAN
•	A439
•	ANT
	K101
	3813
	2293
	990XA
	990XM
	A838
	999XA
	995XM
	989XR
	994XS
	997XS
	983XR
	984XA
	BLACK
	GREEN
	BEIGE
	WHITE

Banchi  
Desks

14.15

Vetrina con cassetto estraibile  
Glass counter with sliding drawer

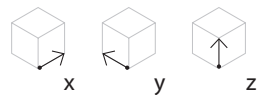
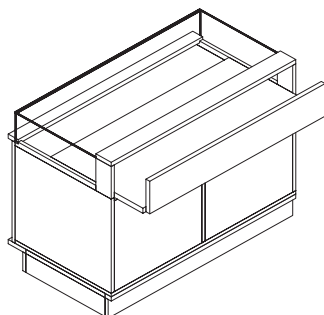
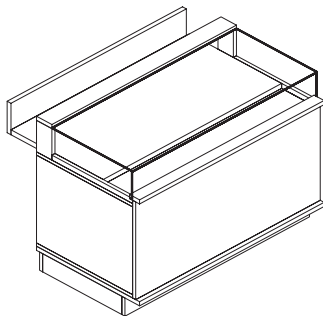

120	67	92	codice code	29.266
-----	----	----	----------------	--------

finitura finish	colori colours
T	
•	7035
•	ACE
•	BIA
	FAG
•	MTZ
•	PAN
•	A439
•	ANT
	K101
	3813
	2293
	990XA
	990XM
	A838
	999XA
	995XM
	989XR
	994XS
	997XS
	983XR
	984XA
	BLACK
	GREEN
	BEIGE
	WHITE



# BANCHI LEGNO

## Accessori

# WOODEN COUNTERS

## Accessories

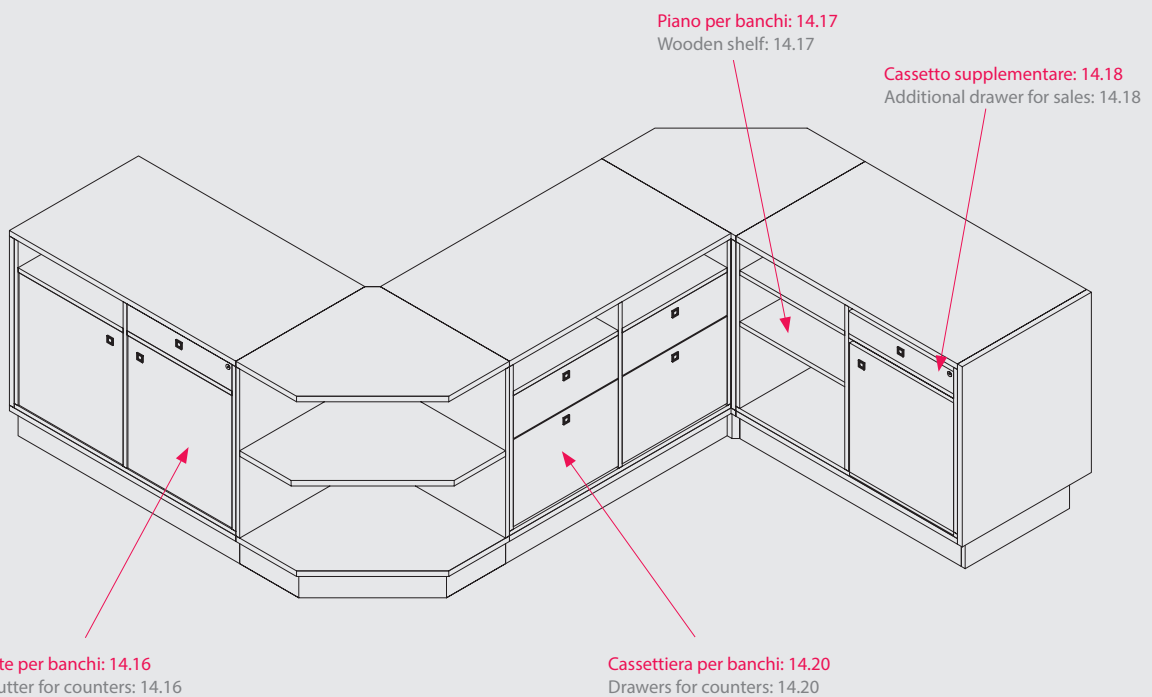
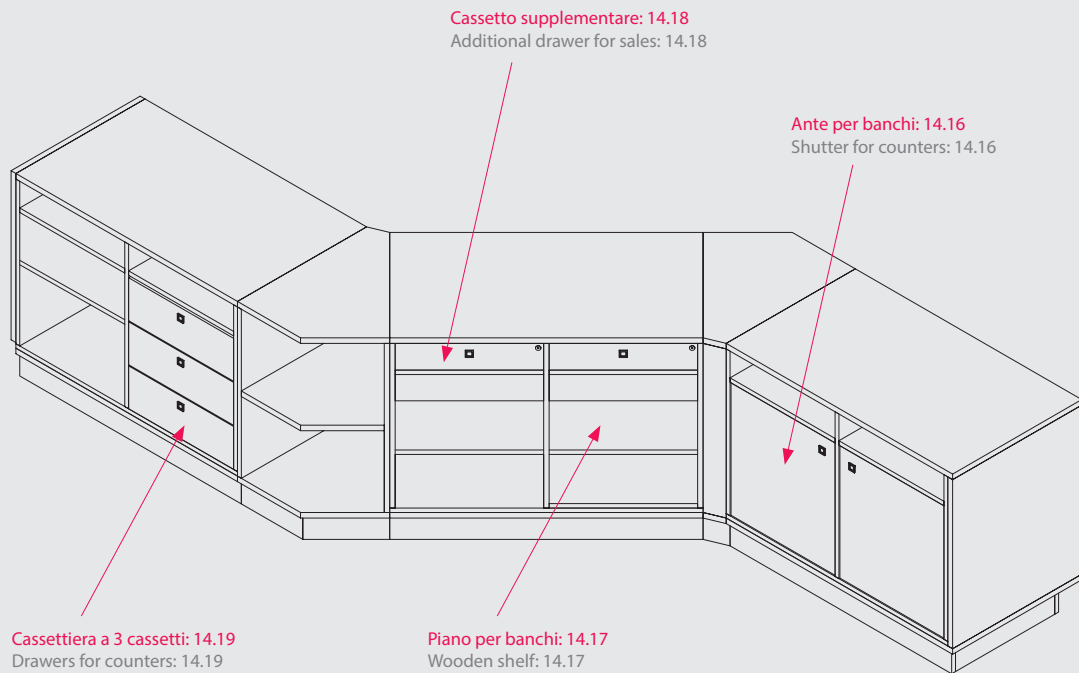

Accessori per Banchi  
Desk Accessories

14.16

Ante per banchi  
Shutter for counters

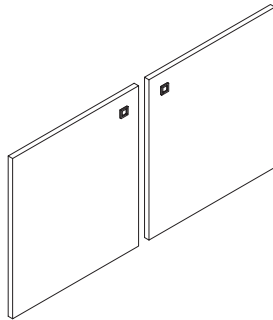

	x	y	z	codice code	note	notes	finitura finish	colori colours	colori colours
dx	54,5	2,5	60	29.232			T		
sx	54,5	2,5	60	29.231				7035	A838
								ACE	999XA
								• BIA	995XM
								FAG	989XR
								MTZ	994XS
								PAN	997XS
								A439	983XR
								ANT	984XA
								K101	BLACK
								3813	GREEN
								2293	BEIGE
								990XA	WHITE
								990XM	



Accessori per Banchi  
Desk Accessories

14.17

Piano per banchi  
Wooden shelf

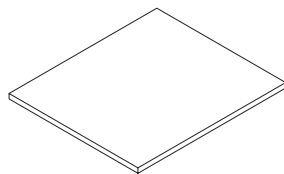

	x	y	z	codice code	note	notes	finitura finish	colori colours	colori colours
	54,5	--	2,5	29.230			T		
								7035	A838
								ACE	999XA
								• BIA	995XM
								FAG	989XR
								MTZ	994XS
								PAN	997XS
								A439	983XR
								ANT	984XA
								K101	BLACK
								3813	GREEN
								2293	BEIGE
								990XA	WHITE
								990XM	



Accessori per Banchi  
Desk Accessories

14.18

Cassetto supplementare per banchi  
Additional drawer for sales and showcase counter

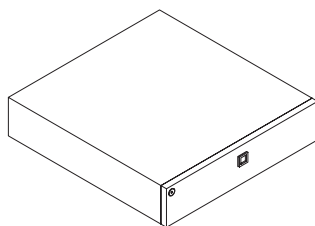

	x	y	z	codice code	note	notes	finitura finish	colori colours	colori colours
	54,5	--	12	29.229			T		
								7035	A838
								ACE	999XA
								• BIA	995XM
								FAG	989XR
								MTZ	994XS
								PAN	997XS
								A439	983XR
								ANT	984XA
								K101	BLACK
								3813	GREEN
								2293	BEIGE
								990XA	WHITE
								990XM	



Accessori per Banchi  
Desk Accessories

14.19

Cassettiera per banchi a 3 cassetti  
Drawers for counters (3 drawer version)

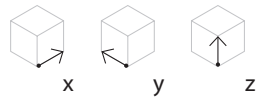
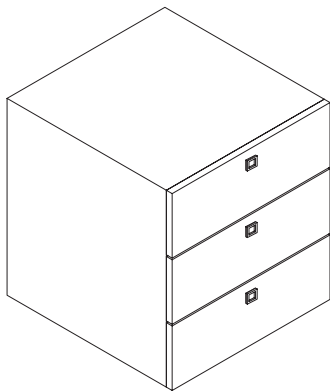

54,5    --    60

codice  
code

29.227

note  
notes

finitura  
finish

colori  
colours

colori  
colours

note	notes	finitura	finish	colori	colours
				7035	A838
				ACE	999XA
				• BIA	995XM
				FAG	989XR
				MTZ	994XS
				PAN	997XS
				A439	983XR
				ANT	984XA
				K101	BLACK
				3813	GREEN
				2293	BEIGE
				990XA	WHITE
				990XM	

Accessori per Banchi  
Desk Accessories

14.20

Cassettiera per banchi a 2 cassetti  
Drawers for counters (2 drawer version)

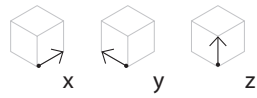
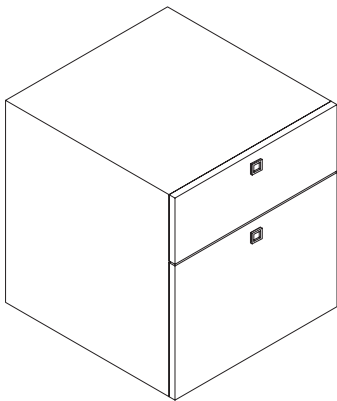

54,5    --    60

codice  
code

29.228

note  
notes

finitura  
finish

colori  
colours

colori  
colours

note	notes	finitura	finish	colori	colours
				7035	A838
				ACE	999XA
				• BIA	995XM
				FAG	989XR
				MTZ	994XS
				PAN	997XS
				A439	983XR
				ANT	984XA
				K101	BLACK
				3813	GREEN
				2293	BEIGE
				990XA	WHITE
				990XM	

Accessori per Banchi  
Desk Accessories

14.21

Illuminazione LED per banchi vetrina  
LED lighting for cash counters

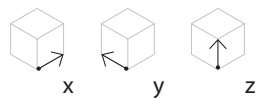
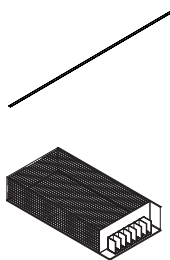

110    --    --

50    --    --

codice  
code

20.470

20.471

note  
notes

LED

LED

TRASFORMATORE

20.469

30W - 12V + CONNETTORE

**Banchi Desks** **14.22** **Piede regolabile aggiuntivo**  
**Additional adjustable foot**

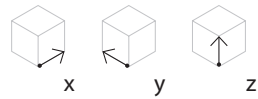
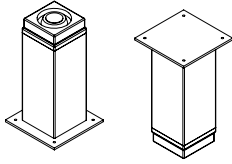

x	y	z	codice code	note notes	finitura finish colori colours
4	4	10	34.739		T • MTZ

finitura finish colori colours
T • MTZ

**Banchi Desks** **14.23** **Maniglia per banchi e cassettiere**  
**Handle for desk and drawers**

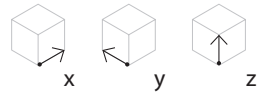
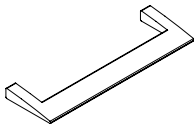

x	y	z	codice code	note notes	finitura finish colori colours
11	2,8	--	34.738		T • INOX

finitura finish colori colours
T • INOX

**Banchi Desks** **14.24** **Maniglia per banchi e cassettiere**  
**Handle for desk and drawers**

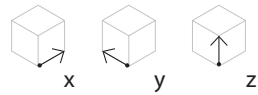
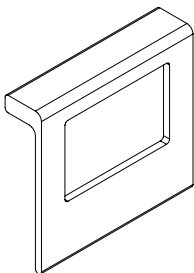

x	y	z	codice code	note notes	finitura finish colori colours
6	2,3	6	34.740		T • INOX

finitura finish colori colours
T • INOX

**Banchi Desks** **14.25** Banco di lavoro con telaio in metallo, piani in legno  
Work table with metal frame and wooden work top

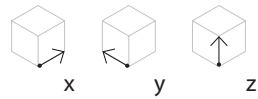
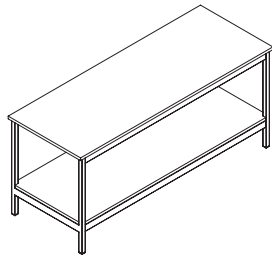

x	y	z	codice code
200	75	89	29.-48

note notes

finitura finish

colori colours

colori colours

note	finitura	colori	colori
notes	finish	colours	colours
T	7035	A838	
	ACE	999XA	
•	BIA	995XM	
	FAG	989XR	
	MTZ	994XS	
	PAN	997XS	
	A439	983XR	
	ANT	984XA	
	K101	BLACK	
	3813	GREEN	
	2293	BEIGE	
	990XA	WHITE	
	990XM		

**Banchi Desks** **14.26** Banco di lavoro con telaio in metallo, piani in legno  
Work table with metal frame and wooden work top

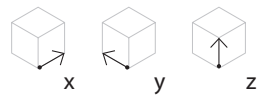
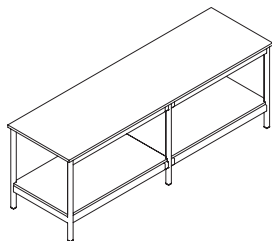

x	y	z	codice code
250	75	89	29.-47

note notes

finitura finish

colori colours

colori colours

note	finitura	colori	colori
notes	finish	colours	colours
T	7035	A838	
	ACE	999XA	
•	BIA	995XM	
	FAG	989XR	
	MTZ	994XS	
	PAN	997XS	
	A439	983XR	
	ANT	984XA	
	K101	BLACK	
	3813	GREEN	
	2293	BEIGE	
	990XA	WHITE	
	990XM		

Accessori per Banchi  
Desk Accessories

14.27

Cassettera in metallo per banchi di lavoro  
Metal drawers for work tables

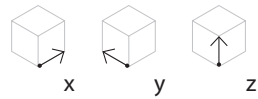
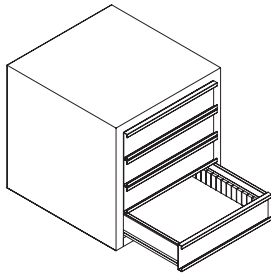

x	y	z	codice code	note notes
56	58	57	21.260	

finitura finish	colori colours
V	2004
	6018
	6027
	• 7035
	AMA
	• ANT
	AZZ
	1001
	• BIA
	BLU
	GIA
	MAR
	• MTZ
	• PAN
	RO3
	BIMCL
	NRMCL
	• OXI

Accessori per Banchi  
Desk Accessories

14.28

Cassetto per banchi di lavoro con telaio in metallo  
Additional drawer for work tables

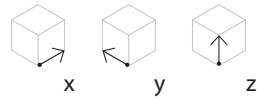
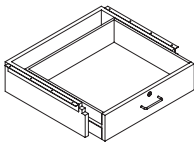

x	y	z	codice code	note notes
56	52	14	29.160	

finitura finish	colori colours
T	7035
	ACE
	BIA
	FAG
	MTZ
•	PAN
	A439
	ANT
	K101
	3813
	2293
	990XA
	990XM
	984XA
	999XA
	995XM
	989XR
	994XS
	997XS
	983XR
	984XA
	BLACK
	GREEN
	BEIGE
	WHITE

# TAVOLI ESPOSITIVI DISPLAY TABLES

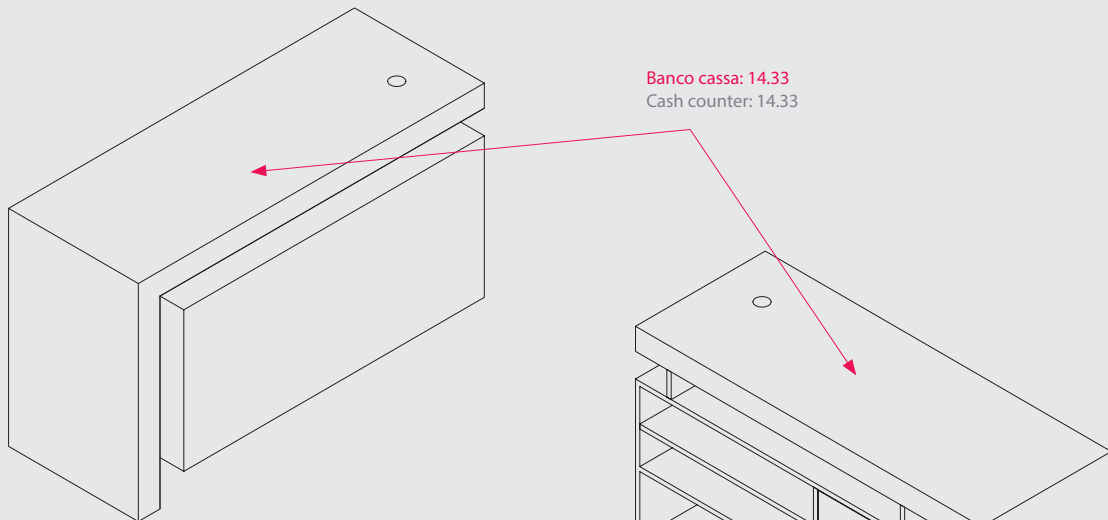

**Banco cassa: 14.33**  
Cash counter: 14.33

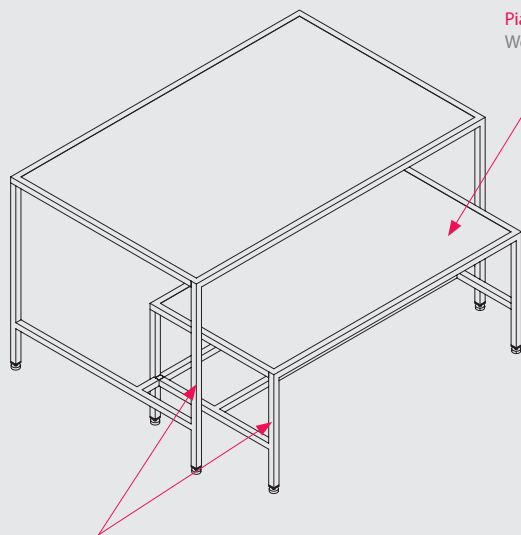

**Piano in legno: 14.30**  
Wooden shelf: 14.30

**Struttura per tavolo: 14.29**  
Metal frame for display: 14.29

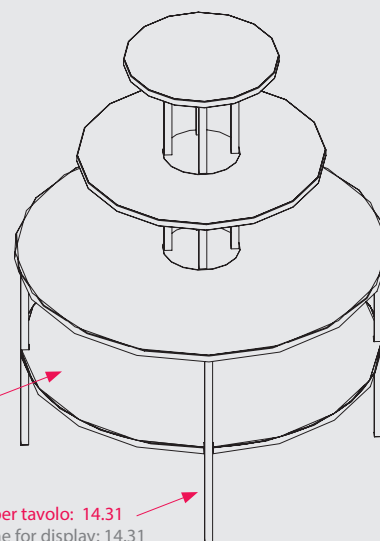

**Piano in legno: 14.32**  
Wooden shelf: 14.32

**Struttura per tavolo: 14.31**  
Metal frame for display: 14.31



Banchi  
Desks

14.29

Tavolo espositivo in tubolare metallo  
Metal frame for display table

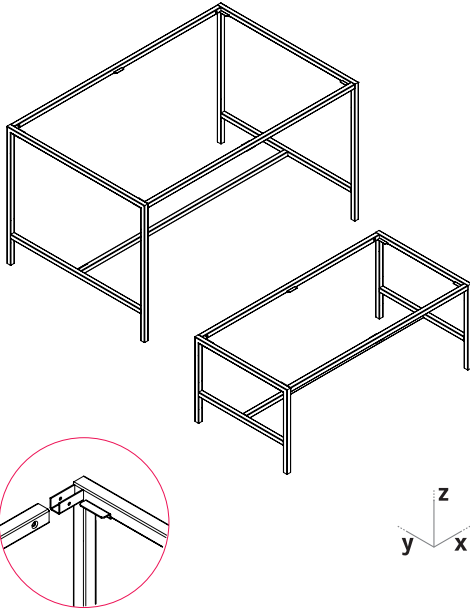

x	y	z	codice code	note notes
120	60	50	22.619	
140	90	80	22.620	

finitura finish	colori colours
V	2004
	6018
	6027
	• 7035
	AMA
	• ANT
	AZZ
	1001
	• BIA
	BLU
	GIA
	MAR
	• MTZ
	• PAN
	RO3
	BIMCL
	NRMCL
	• OXI



Banchi  
Desks

14.30

Piano in legno per tavolo espositivo in tubolare metallo  
Wooden top for metal display table

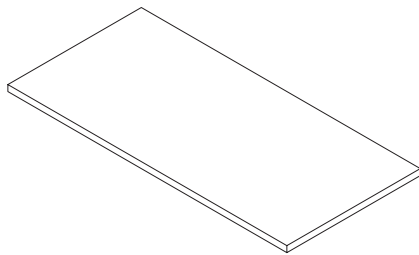

x	y	z	codice code	note notes
115	55	2	22.573	
135	85	2	22.574	



finitura finish	colori colours
T	7035
	ACE
•	BIA
	FAG
	MTZ
	PAN
	A439
	ANT
	K101
	3813
	2293
	990XA
	990XM
	984XA
	999XA
	995XM
	989XR
	994XS
	997XS
	983XR
	984XA
	BLACK
	GREEN
	BEIGE
	WHITE





14.31

Struttura per tavolo tondo a 3 livelli  
Metal frame for round table

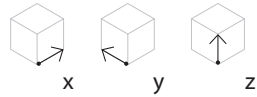
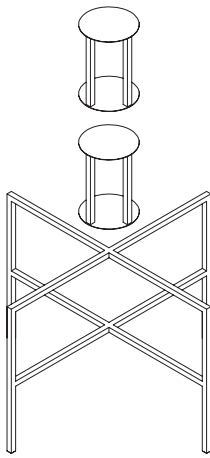

x	y	z	codice code	note notes
116	116	147	22.599	



finitura finish	colori colours
V	2004
	6018
	6027
	• 7035
	AMA
	• ANT
	AZZ
	1001
	• BIA
	BLU
	GIA
	MAR
	• MTZ
	• PAN
	RO3
	BIMCL
	NRMCL
	• OXI



14.32

Piani per banco tondo a 3 livelli  
Wooden shelves for

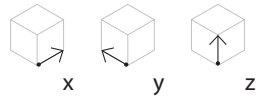
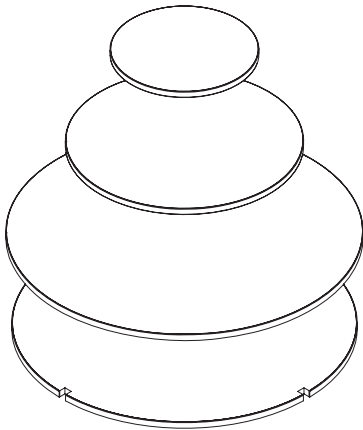

x	y	z	codice code	note notes
50	50	2,5	40.-29	
80	80	2,5	40.-30	
120	120	2,5	40.-32	
116	116	2,5	40.-31	



finitura finish	colori colours
T	7035
	ACE
•	BIA
	FAG
	MTZ
	PAN
	A439
	ANT
	K101
	3813
	2293
	990XA
	990XM
	984XA
	999XA
	995XM
	989XR
	994XS
	997XS
	983XR
	984XA
	BLACK
	GREEN
	BEIGE
	WHITE



14.33

Banco cassa con top in tamburato e cassette  
Stand-alone cash counter with top and drawers

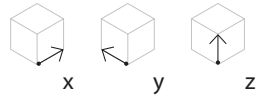

x      y      z      codice code      note notes

120      60      95      29.271

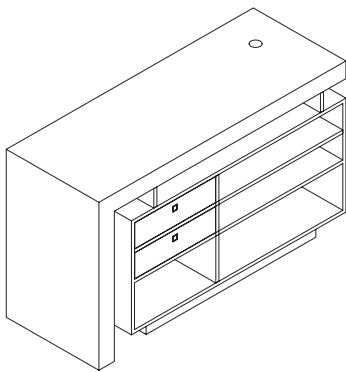
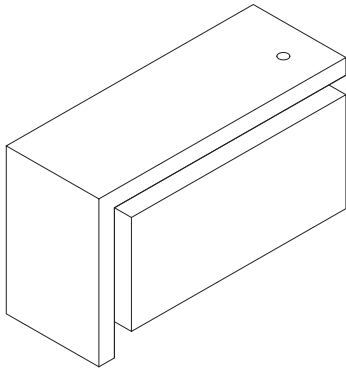

finitura finish	colori colours
T	7035
	ACE
•	BIA
	FAG
	MTZ
	PAN
	A439
	ANT
	K101
	3813
	2293
	990XA
	990XM
	984XA
	999XA
	995XM
	989XR
	994XS
	997XS
	983XR
	984XA
	BLACK
	GREEN
	BEIGE
	WHITE



Banchi  
Desks

14.34

Colonna in legno a 4 vani  
Wooden column with 4 rooms

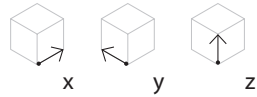
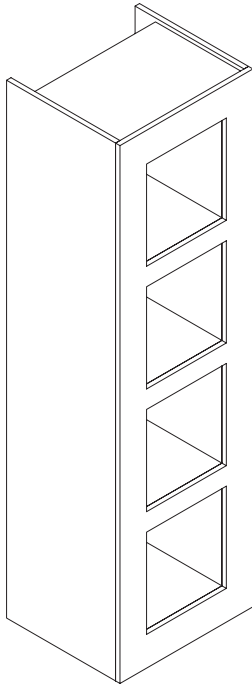

x	y	z	codice code	note notes
67	62	267	30.378	

finitura finish	colori colours
T	
	7035
	ACE
•	BIA
	FAG
	MTZ
	PAN
	A439
	ANT
	K101
	3813
	2293
	990XA
	990XM
	984XA
	999XA
	995XM
	989XR
	994XS
	997XS
	983XR
	984XA
	BLACK
	GREEN
	BEIGE
	WHITE



Banchi  
Desks

14.35

Alveare in legno con vani  
Wooden beehive with rooms

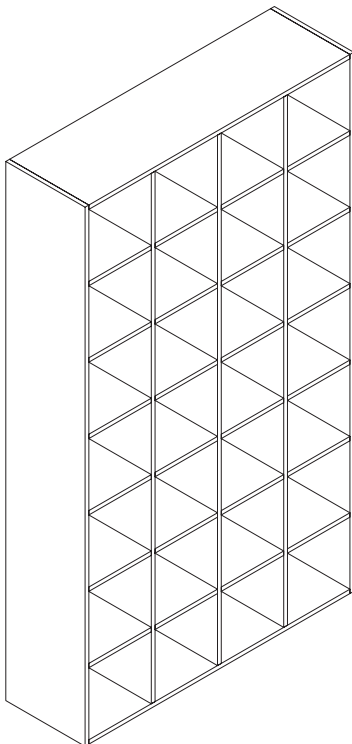

x	y	z	codice code	note notes
102	40	235	22.600	21 vani
136	40	235	22.601	28 vani
169	40	235	22.602	35 vani

finitura finish	colori colours
T	
	7035
	ACE
•	BIA
	FAG
	MTZ
	PAN
	A439
	ANT
	K101
	3813
	2293
	990XA
	990XM
	984XA
	999XA
	995XM
	989XR
	994XS
	997XS
	983XR
	984XA
	BLACK
	GREEN
	BEIGE
	WHITE

**note**  
*notes*

**note**  
*notes*

# 15

## Cabine prova *Dressing rooms*

Cabine prova, specchi e portabiti.  
*Dressing rooms, mirrors and garment racks.*

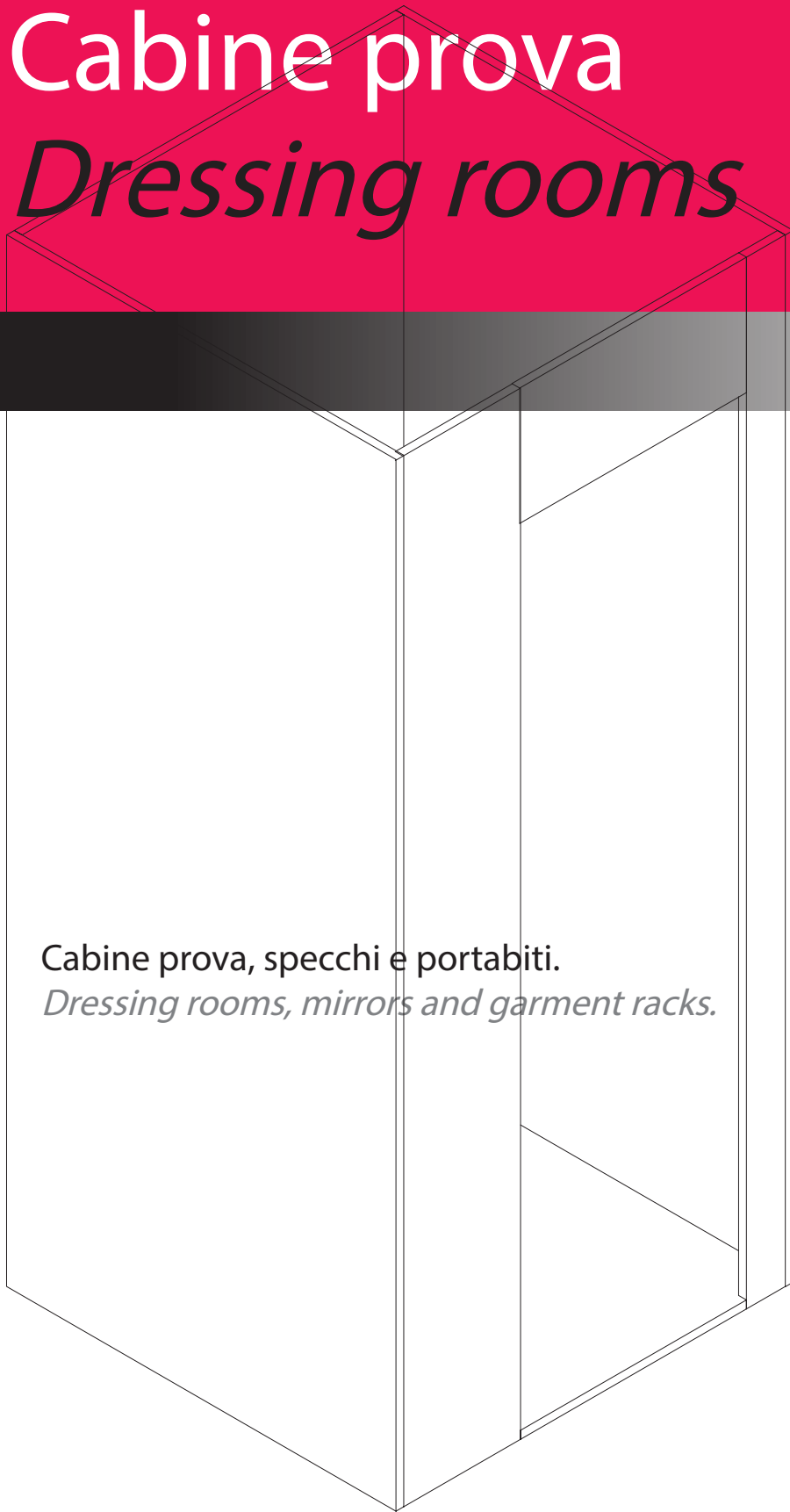



Composizione con cabina prova  
Setting with dressing room

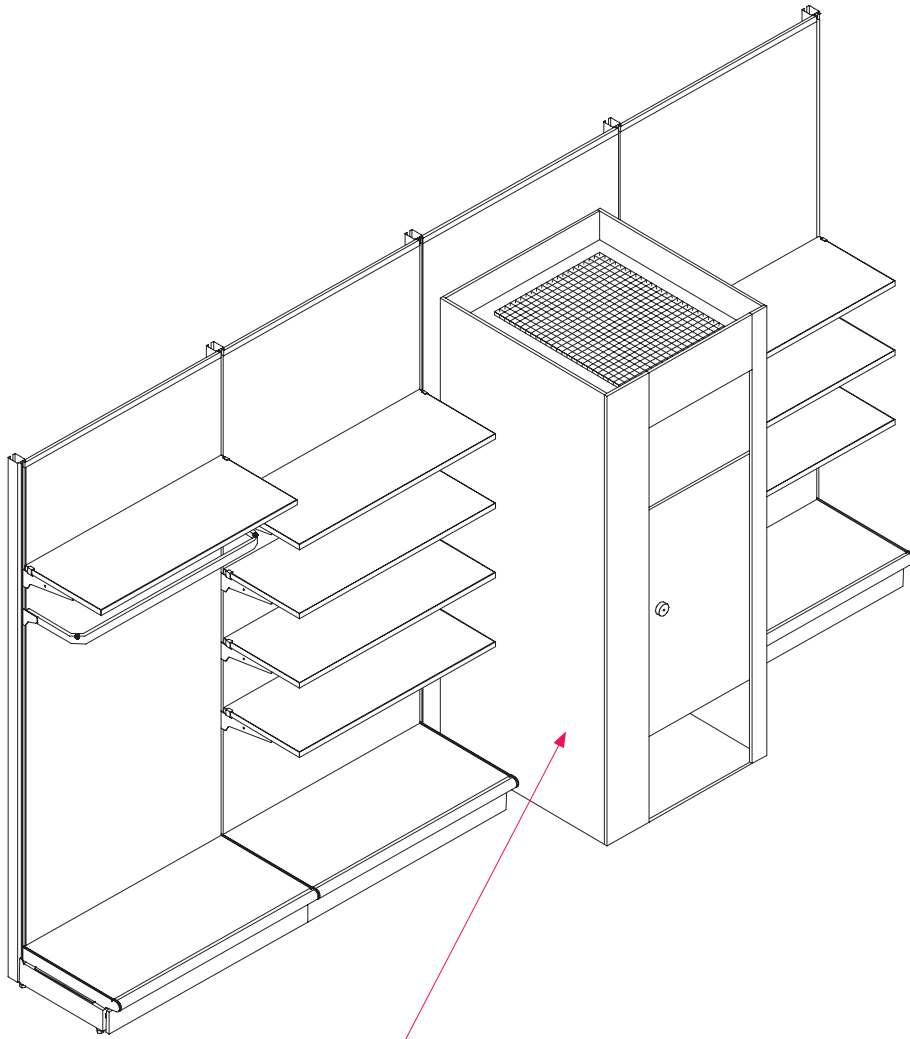

Cabina prova: 15.3  
Dressing room: 15.3

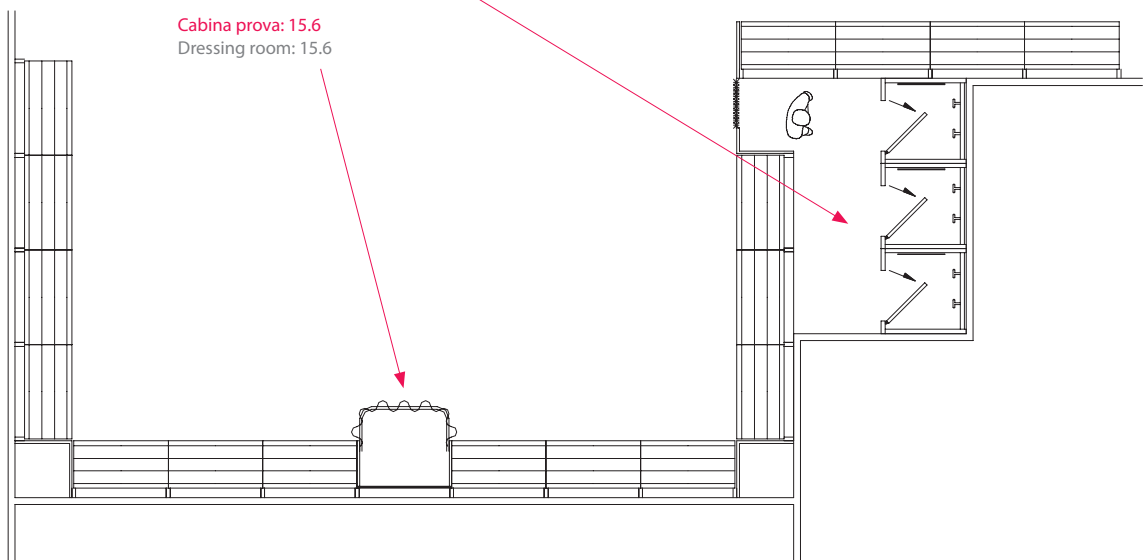

Cabina prova: 15.6  
Dressing room: 15.6





Cabine Prova  
Dressing Rooms

15.1

Cabina prova in legno con supporto tubolare per tenda  
Wooden dressing room with support for curtain

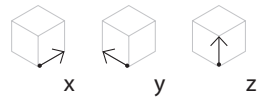
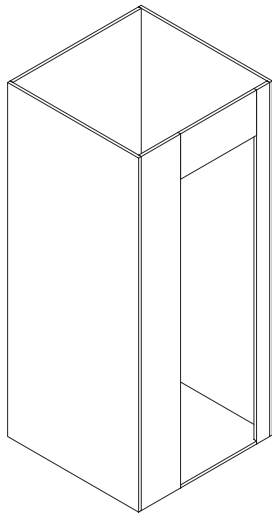

x	y	z	codice code	note notes
96	100	234	30.247	

finitura finish	colori colours
T	
	7035
	ACE
•	BIA
	FAG
	MTZ
	PAN
	A439
	ANT
	K101
	3813
	2293
	990XA
	990XM
	984XA
	999XA
	995XM
	989XR
	994XS
	997XS
	983XR
	984XA
	BLACK
	GREEN
	BEIGE
	WHITE

Accessori per Cabine Prova  
Dressing Room Accessories

15.2

Tenda per cabina prova con anelli  
Curtain for wooden dressing room with rings

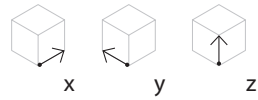
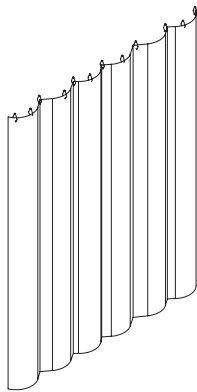

x	y	z	codice code	note notes
140	--	200	30.-64	

finitura finish	colori colours
T	
•	GRI
•	PAN

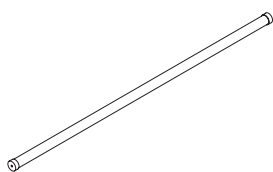

Tubo reggitenda ø 2,5 cm con ghiere  
Curtain-bearing crosspiece ø 2,5 cm with nuts

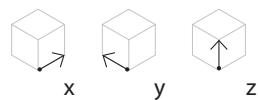

x	y	z	codice code	finitura e colore finish & colour	note notes
91	--	--	26.-47	C	



15.3

Cabina prova in legno con porta parziale a battente  
Wooden dressing room with lockable door

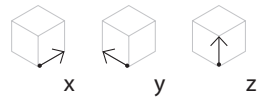
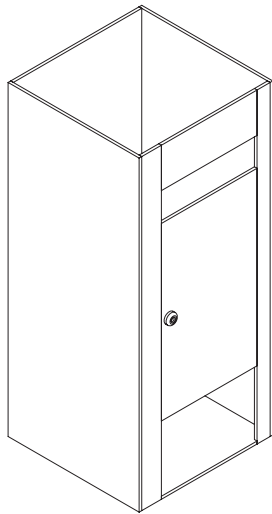

x	y	z	codice code	note notes
96	100	234	30.248	

finitura finish	colori colours
T	
	7035
	ACE
•	BIA
	FAG
	MTZ
	PAN
	A439
	ANT
	K101
	3813
	2293
	990XA
	990XM
	984XA
	999XA
	995XM
	989XR
	994XS
	997XS
	983XR
	984XA
	BLACK
	GREEN
	BEIGE
	WHITE

Accessori per Cabine Prova  
Dressing Room Accessories

15.4

Pedana per cabina prova (con tenda o porta) rivestita vinilico  
Coated platform for dressing rooms (with curtains or with door)

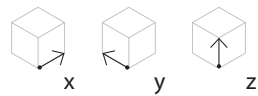
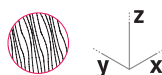
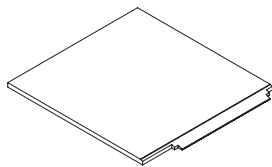

x	y	z	codice code	finitura e colore finish & colour	note notes
91	98	2,5	30.253	T	

Accessori per Cabine Prova  
Dressing Room Accessories

15.5

Pannello di chiusura superiore per cabina prova (con tenda o porta)  
Upper closing panel for dressing rooms (with curtains or with door)

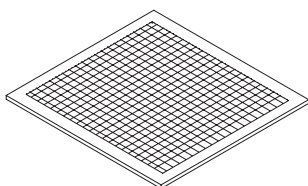

x	y	z	codice code	note notes
91	98	2	30.254	

Il grigliato è in PVC bianco  
The top grid is made of white PVC

finitura finish	colori colours	colori colours
T		
	7035	A838
	ACE	999XA
•	BIA	995XM
	FAG	989XR
	MTZ	994XS
	PAN	997XS
	A439	983XR
	ANT	984XA
	K101	BLACK
	3813	GREEN
	2293	BEIGE
	990XA	WHITE
	990XM	



15.6

Cabina prova per elementi a parete con spalle in legno e supporto tubolare per tenda  
Dressing room for wall units with lateral closures and support for curtain

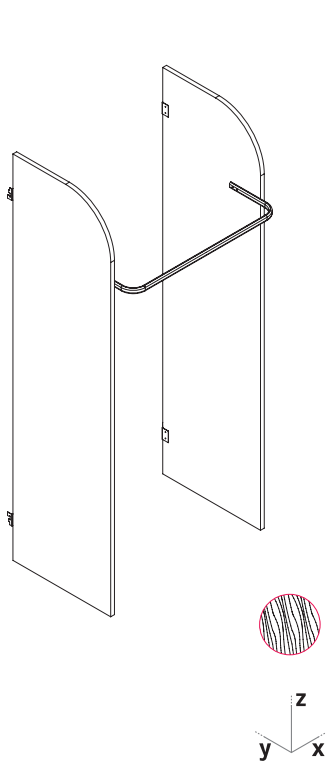

x	y	z	codice code	note notes
100	90	234	30.249	

finitura finish	colori colours
T	
•	7035
•	ACE
•	BIA
•	FAG
•	MTZ
•	PAN
•	A439
•	ANT
	K101
	3813
	2293
	990XA
	990XM
	A838
	999XA
	995XM
	989XR
	994XS
	997XS
	983XR
	984XA
	BLACK
	GREEN
	BEIGE
	WHITE

Accessori per Cabine Prova  
Dressing Room Accessories

15.7

Spalla laterale in legno  
Wooden side panel with supports for dressing room

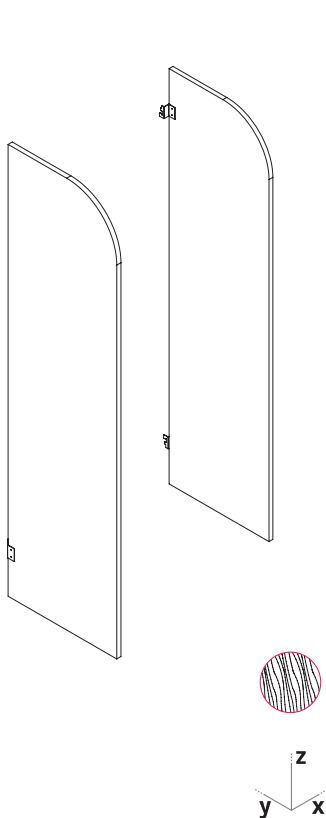

	x	y	z	codice code	note notes
dx rh	2,5	65	234	30.250	
sx lh	2,5	65	234	30.251	

finitura finish	colori colours
T	
•	7035
•	ACE
•	BIA
•	FAG
•	MTZ
•	PAN
•	A439
•	ANT
	K101
	3813
	2293
	990XA
	990XM
	A838
	999XA
	995XM
	989XR
	994XS
	997XS
	983XR
	984XA
	BLACK
	GREEN
	BEIGE
	WHITE

Tenda per cabina prova con anelli  
Curtain for dressing room with rings

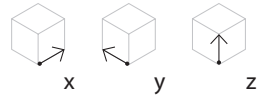
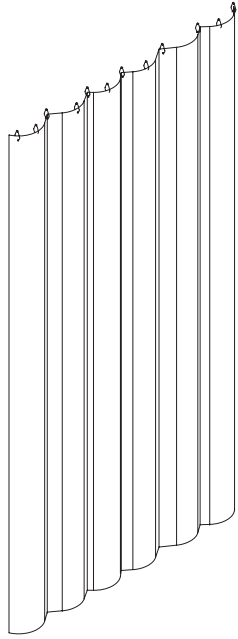

	x	y	z	codice code	note notes
	176	--	180	30.-79	

finitura finish	colori colours
T	
•	7035
	ACE
	BIA
	FAG
	MTZ
•	PAN
	A439
	ANT
	K101
	3813
	2293
	990XA
	990XM
	984XA
	999XA
	995XM
	989XR
	994XS
	997XS
	983XR
	984XA
	BLACK
	GREEN
	BEIGE
	WHITE

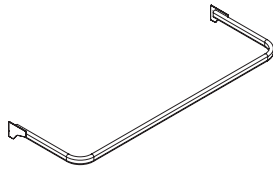

Tubo ovale per cabina prova  
Oval tubular bar for dressing room

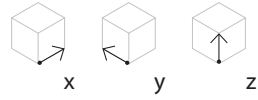

	x	y	z	codice code	finitura e colore finish & colour	note notes
	94	30	--	30.252	C	

Accessori per Cabine Prova  
Dressing Room Accessories

15.9

Specchio per cabine prova  
Mirror for dressing rooms

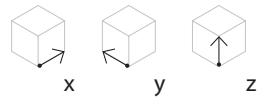

60 -- 160

codice  
code

31.-01

finitura e  
colore  
finish &  
colour

N

note  
notes

Supporto per specchio  
Mirror support

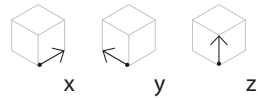

60 -- --

codice  
code

34.-44

finitura e  
colore  
finish &  
colour

C

note  
notes

n.2 supporti per ogni  
specchio

n.2 supports each  
mirror

Accessori per Cabine Prova  
Dressing Room Accessories

15.10

Attaccapanni per camerino prova  
PVC garment rack for dressing rooms

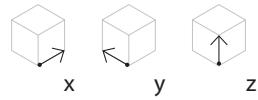
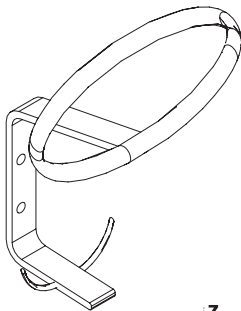

-- -- --

codice  
code

34.585

finitura e  
colore  
finish &  
colour

C

note  
notes

**note**  
*notes*

**note**  
*notes*

# Comunicazione

## *Posters and signs*

# 16

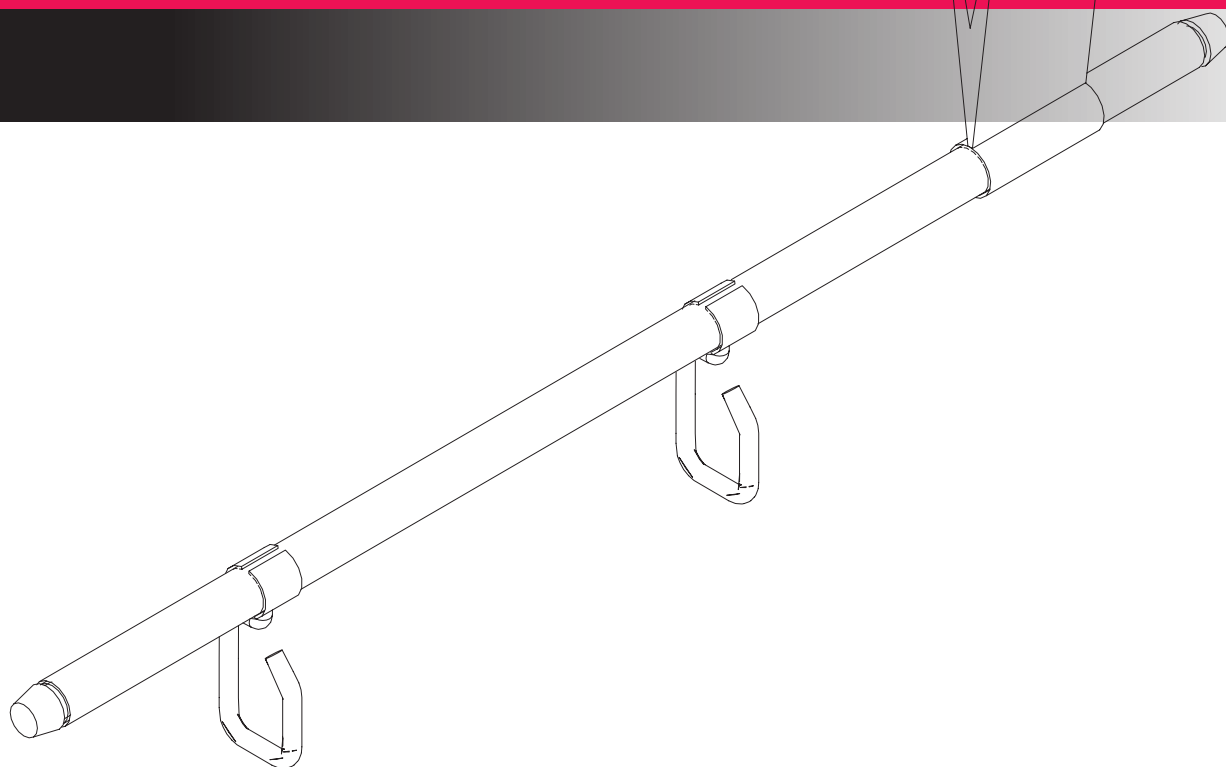

Cartelli, cornici e aste portacartello, bracci portacartello, evidenziatori per ripiani e pannelli, gripper, .

*Posters, sign holders, stems for sign holder plates.*

*Shelves and back panels highlighter, gripper.*





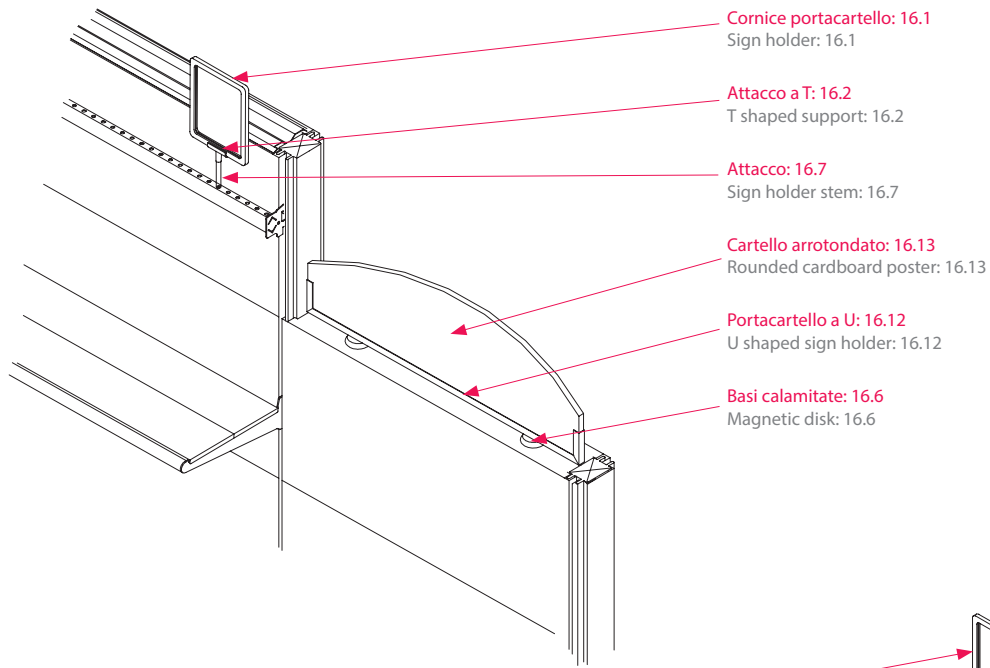

**Cornice portacartello: 16.1**  
Sign holder: 16.1

**Attacco a T: 16.2**  
T shaped support: 16.2

**Asta in alluminio: 16.3**  
Aluminium stem: 16.3

**Asta in metallo: 16.4**  
Metal stem: 16.4

**Base in metallo: 16.5**  
Metal base: 16.5

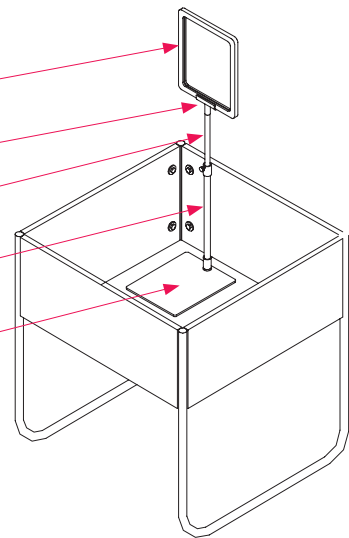

**Cornice portacartello: 16.1**  
Sign holder: 16.1

**Attacco a T: 16.2**  
T shaped support: 16.2

**Basi calamitate: 16.6**  
Magnetic disk: 16.6

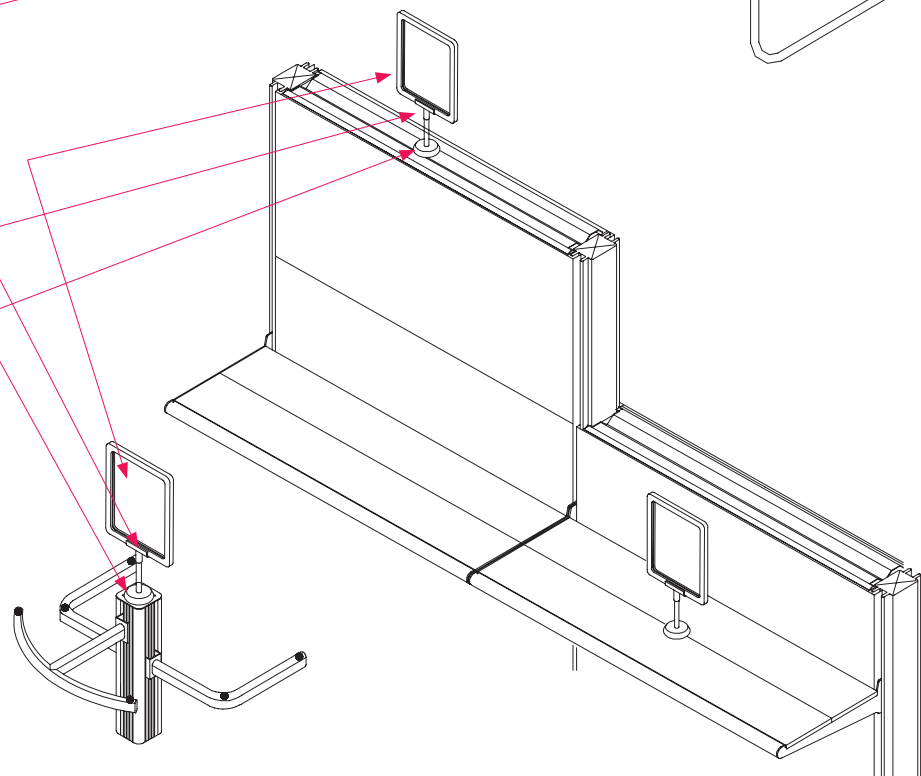

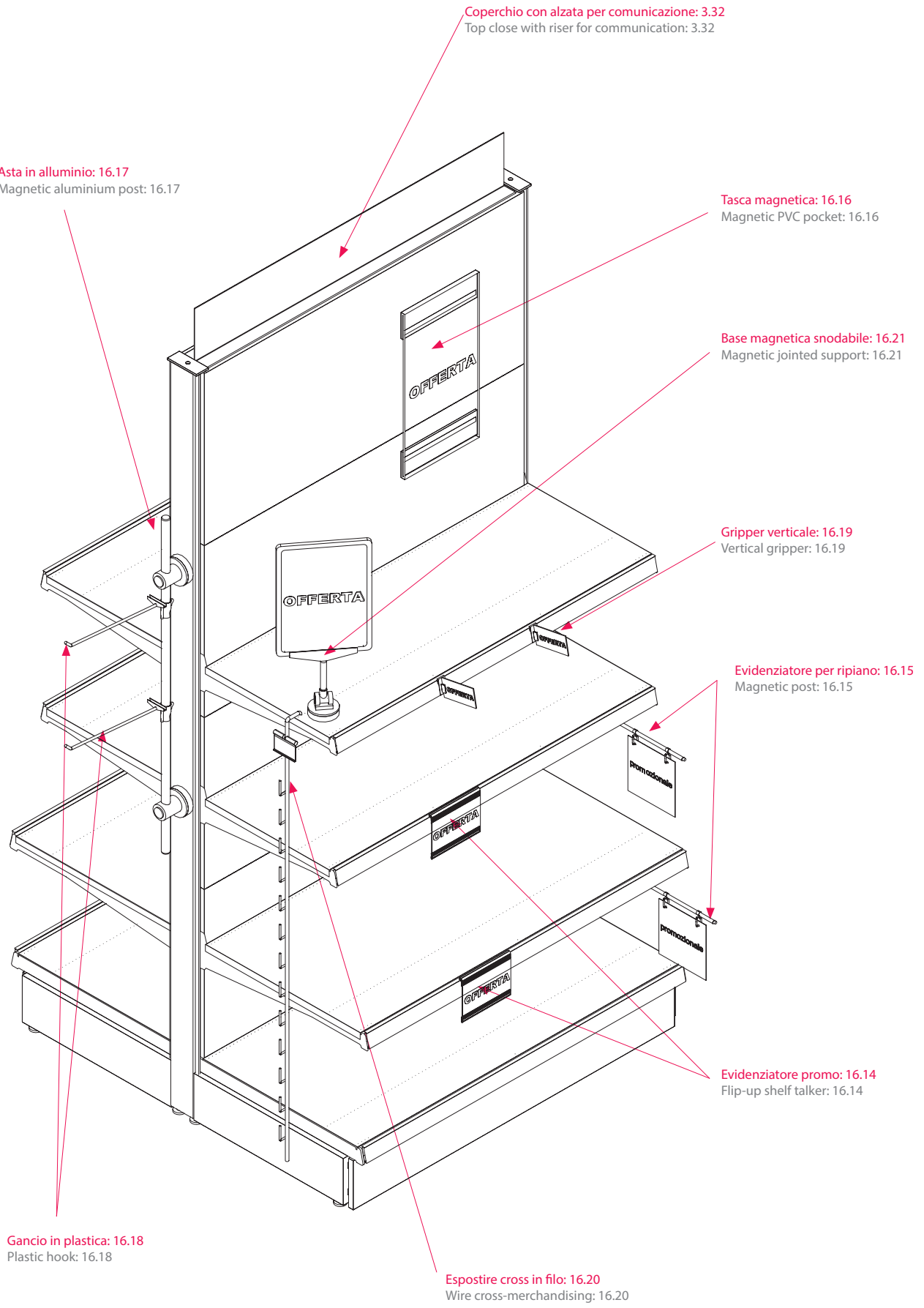



Cartellonistica  
Posters and Signs

16.1

Cornice portacartello in PVC  
PVC sign holder

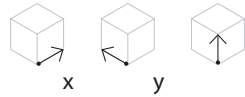
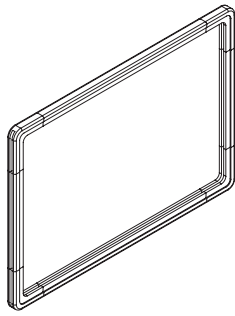

	x	y	z	codice code	finitura e colore finish & colour	note notes
	21	--	14,8	35.102	T BIA	
	29,7	--	21	35.103	T BIA	



Cartellonistica  
Posters and Signs

16.2

Attacco a T per cornici  
T shaped PVC support for sign holder

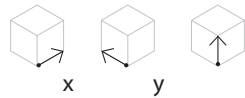
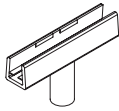

	x	y	z	codice code	finitura e colore finish & colour	note notes
	5,5	--	4	35.123	T TRA	



Cartellonistica  
Posters and Signs

16.3

Asta in alluminio per attacco a T  
Aluminium stem for T shaped support

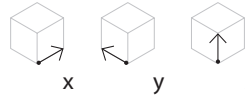

	x	y	z	codice code	finitura e colore finish & colour	note notes
	--	--	27	35.125	N	



Cartellonistica  
Posters and Signs

16.4

Asta in metallo con viti  
Metal stem with screws

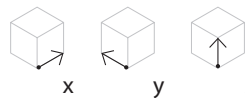

	x	y	z	codice code	finitura e colore finish & colour	note notes
	--	--	34	35.126	C	

**Cartellonistica**  
Posters and Signs

**16.5** Base in metallo per cornice portacartello  
Metal base with poster staff

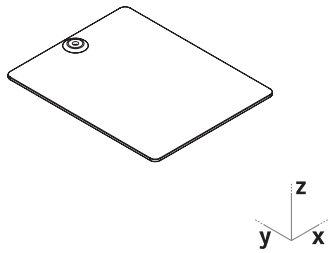

x	y	z	codice code	note notes
16	20	--	11.-79	

finitura finish	colori colours
<b>C</b>	<b>V</b>
	2004
	6018
	6027
	7035
	AMA
	ANT
	AZZ
	1001
	BIA
	BLU
	GIA
	MAR
	MTZ
	PAN
	RO3
	BIMCL
	NRMCL
	OXI
	---

**Cartellonistica**  
Posters and Signs

**16.6** Base calamitata ø 5 cm  
Magnetic disk ø 5 cm

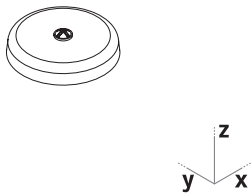

x	y	z	codice code	finitura e colore finish & colour	note notes
--	--	--	35.166	T NER	

**Cartellonistica**  
Posters and Signs

**16.7** Attacco per base calamitata con vite  
Sign holder stem for magnetic disk with screws

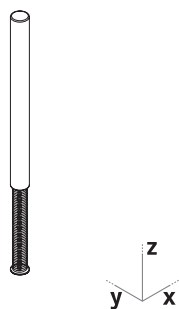

x	y	z	codice code	finitura e colore finish & colour	note notes
--	--	10	35.145	C	





Cartellonistica  
Posters and Signs

16.11

Braccio portacartello a L in tubo  
Tubular L shaped stem for sign holder plate

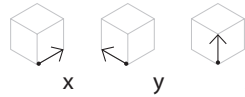
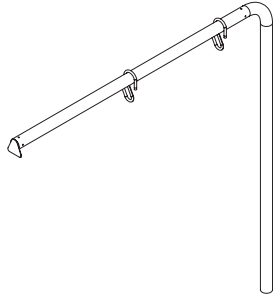

x	y	z	codice code
61	--	60	35.148

note notes	finitura finish	colori colours	colori colours
	V	2004	MAR
		6018	• MTZ
		6027	• PAN
		• 7035	RO3
		AMA	BIMCL
		• ANT	NRMCL
		AZZ	• OXI
		1001	GIA
		• BIA	
		BLU	



Cartellonistica  
Posters and Signs

16.12

Portacartello a U  
U shaped sign holder

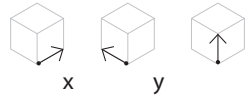
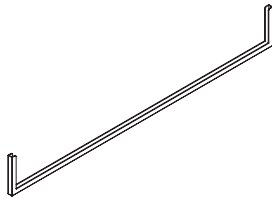

x	y	z	codice code
95	--	12	34.336

Da utilizzarsi con la base calamitata: 16.6  
To be used with magnetic disk: 16.6

note notes	finitura finish	colori colours	colori colours
	V	2004	MAR
		6018	• MTZ
		6027	• PAN
		• 7035	RO3
		AMA	BIMCL
		• ANT	NRMCL
		AZZ	• OXI
		1001	GIA
		• BIA	
		BLU	



Cartellonistica  
Posters and Signs

16.13

Cartello arrotondato  
Rounded cardboard poster

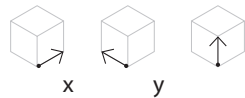
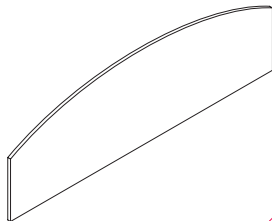

x	y	z	codice code
94,5	1	20	35.138

note notes	finitura finish	colori colours	colori colours
	T		
•		7035	A838
•		ACE	999XA
•		BIA	995XM
		FAG	989XR
•		MTZ	994XS
•		PAN	997XS
•		A439	983XR
•		ANT	984XA
		K101	BLACK
		3813	GREEN
		2293	BEIGE
		990XA	WHITE
		990XM	





Comunicazione  
Merchandising

16.14

Evidenziatore "Promo" basculante per profili  
Flip-up shelf talker for PVC profiles

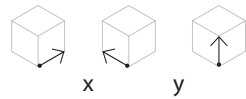
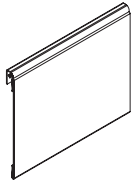

	x	y	z	codice code	finitura e colore finish & colour
A7	10,5	7,4	--	37.-07	TTRA
A6	14,8	10,5	--	37.-01	TTRA



Comunicazione  
Merchandising

16.15

Evidenziatore per ripiano con calamite  
Magnetic post for signage

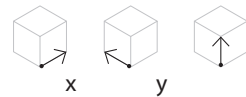
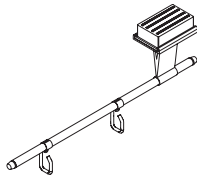

	x	y	z	codice code	finitura e colore finish & colour
	2,5	0,7	2	37.-03	TTRA



Comunicazione  
Merchandising

16.16

Tasca magnetica per comunicazione su pannelli  
Magnetic post pocket for signages

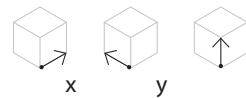
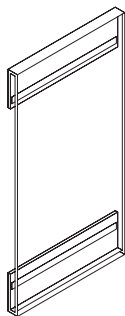

	x	y	z	codice code	finitura e colore finish & colour
A4	21	--	29,7	37.-04	TTRA







Comunicazione  
Merchandising

16.17

Asta in alluminio con magneti  
Aluminium post with magnets

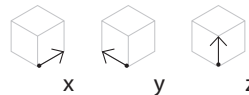

x	y	z	codice code	finitura e colore finish & colour
1	--	10	37.-10	N



Comunicazione  
Merchandising

16.18

Gancio regolabile in ABS per asta in alluminio  
Adjustable plastic hook for aluminium post

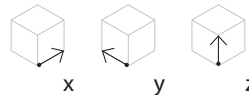
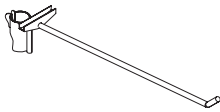

x	y	z	codice code	finitura e colore finish & colour
1	30	--	37.-14	N



Comunicazione  
Merchandising

16.19

Gripper verticale per profili  
Vertical gripper for profiles

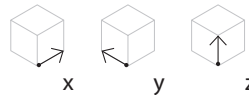
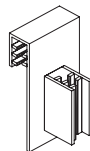

x	y	z	codice code	finitura e colore finish & colour
1	1,5	3,5	37.-02	TTRA



Comunicazione  
Merchandising

16.20

Espositore in filo per cross-merchandising con portaprezzo  
Wire display for cross-merchandising with price holder

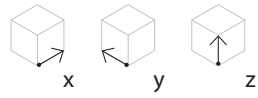
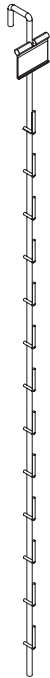

x

y

z

codice  
code

finitura e  
colore  
finish &  
colour

--

--

12

37.-08

C



Comunicazione  
Merchandising

16.21

Base magnetica con attacco snodabile per cornici PVC  
Magnetic jointed support for PVC frames

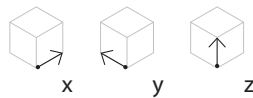
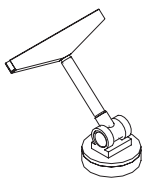

x

y

z

codice  
code

finitura e  
colore  
finish &  
colour

20

2

4

37.-05

N



**note**

*notes*

# Colori & finiture

## *Finish & colours*

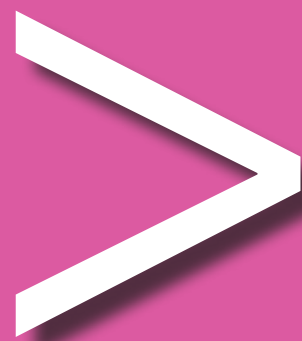

Metalli Verniciati  
*Painted Metals*



Metalli Plasticati  
*Coated Metals*



Essenze Legno  
*Faced Wood*



### Metalli Verniciati Painted Metals



**BIA**  
Bianco  
*White*

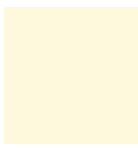

**PAN**  
Panna  
*Pan*



**1001**  
Beige  
*Beige*



**GIA**  
Giallo  
*Yellow*



**2004**  
Arancione  
*Orange*



**AMA**  
Amaranto  
*Amaranth*



**RO3**  
Rosso  
*Red*



**6018**  
Verde  
*Green*



**6027**  
Verde  
*Green*



**AZZ**  
Azzurro  
*Light Blue*



**BLU**  
**BLU**  
*Blue*



**ANT**  
Antracite  
*Anthracite*



**7035**  
Grigio Luce  
*Light Gray*



**MTZ**  
Metallizzato  
*Metallized*



**MAR**  
Marrone  
*Brown*



**MROP**  
Marrone Opaco  
*Brown*



**OXI**  
Grigio Metal  
*Metal Gray*



### Metalli Plastificati Plastic Coated Metals



**BIA**  
Bianco  
*White*



**PAN**  
Panna  
*Cream*



**7035**  
Grigio  
*Grey*



### Metalli Glitterati Glitter Metals

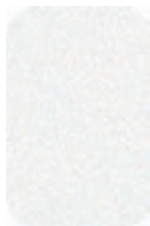

**BIMCL**  
Bianco  
*White Glitter*

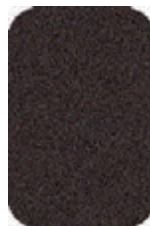

**MRNCL**  
Bronzo  
*Bronze*

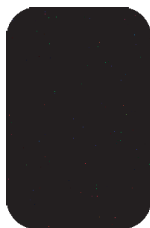

**NRMCL**  
Nero  
*Black Glitter*



### Metalli Verniciati a Richiesta Extra Painted Metals





Essenze Legno - Tinte unite  
Faced Wood

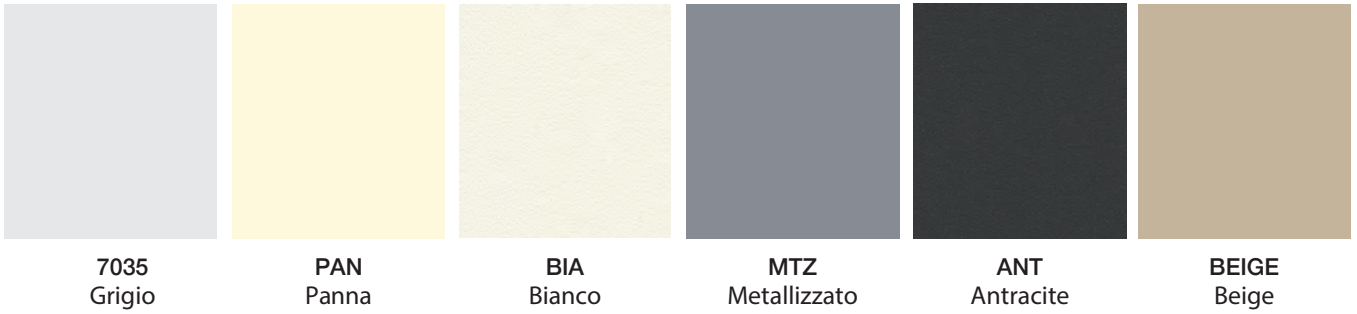

Essenze Nobilitati  
FacedWood



